

Candlesticks, Fibonacci, and Chart Pattern Trading Tools

A Synergistic
Strategy to
Enhance
Profits and
Reduce Risk

Robert Fischer and Jens Fischer

Includes a CD-ROM with easy-to-use technical tools



abcBourse.ir



@abcBourse_ir

مرجع آموزش بورس



باز نشر :

CANDLESTICKS, FIBONACCI, AND CHART PATTERN TRADING TOOLS

A SYNERGISTIC STRATEGY TO ENHANCE
PROFITS AND REDUCE RISK

ROBERT FISCHER
JENS FISCHER



WILEY

JOHN WILEY & SONS, INC.



[abcBourse.ir](http://www.abcBourse.ir)



@abcBourse_ir

مرجع آموزش بورس



باز نشر :



abcBourse.ir



@abcBourse_ir

مرجع آموزش بورس



بازنشر :

CANDLESTICKS, FIBONACCI, AND CHART PATTERN TRADING TOOLS



abcBourse.ir



@abcBourse_ir

مرجع آموزش بورس



باز نشر :

Founded in 1870, John Wiley & Sons is the oldest independent publishing company in the United States. With offices in North America, Europe, Australia, and Asia, Wiley is globally committed to developing and marketing print and electronic products and services for our customers' professional and personal knowledge and understanding.

The Wiley Trading series features books by traders who have survived the market's ever-changing temperament and have prospered—some by re-investing systems, others by getting back to basics. Whether a novice trader, professional, or somewhere in-between, these books will provide the advice and strategies needed to prosper today and well into the future.

For a list of available titles, visit our web site at www.WileyFinance.com.



abcBourse.ir



@abcBourse_ir

مرجع آموزش بورس



بازنشر :

CANDLESTICKS, FIBONACCI, AND CHART PATTERN TRADING TOOLS

A SYNERGISTIC STRATEGY TO ENHANCE
PROFITS AND REDUCE RISK

ROBERT FISCHER
JENS FISCHER



WILEY

JOHN WILEY & SONS, INC.



<http://www.abcBourse.ir>



@abcBourse_ir

مرجع آموزش بورس



باز نشر :

Copyright © 2003 by Robert Fischer, Dr. Jens Fischer. All rights reserved.

Published by John Wiley & Sons, Inc., Hoboken, New Jersey.
Published simultaneously in Canada.

PHI-spirals, PHI-ellipse, PHI-channel, and www.fibotrader.com are registered trademarks and protected by U.S. Trademark Law. Any unauthorized use without the express written permission of Fischer Finance Consulting AG, CH-6300 Zug, Switzerland, or Robert Fischer is a violation of the law.

Source of all figures is FAM Research 2002.

No part of this publication may be reproduced, stored in a retrieval system, or transmitted in any form or by any means, electronic, mechanical, photocopying, recording, scanning, or otherwise, except as permitted under Section 107 or 108 of the 1976 United States Copyright Act, without either the prior written permission of the Publisher, or authorization through payment of the appropriate per-copy fee to the Copyright Clearance Center, Inc., 222 Rosewood Drive, Danvers, MA 01923, 978-750-8400, fax 978-750-4470, or on the web at www.copyright.com. Requests to the Publisher for permission should be addressed to the Permissions Department, John Wiley & Sons, Inc., 111 River Street, Hoboken, NJ 07030, 201-748-6011, fax 201-748-6008, e-mail: permcoordinator@wiley.com.

Limit of Liability/Disclaimer of Warranty: While the publisher and author have used their best efforts in preparing this book, they make no representations or warranties with respect to the accuracy or completeness of the contents of this book and specifically disclaim any implied warranties of merchantability or fitness for a particular purpose. No warranty may be created or extended by sales representatives or written sales materials. The advice and strategies contained herein may not be suitable for your situation. You should consult with a professional where appropriate. Neither the publisher nor author shall be liable for any loss of profit or any other commercial damages, including but not limited to special, incidental, consequential, or other damages.

For general information on our other products and services, or technical support, please contact our Customer Care Department within the United States at 800-762-2974, outside the United States at 317-572-3993 or fax 317-572-4002.

Wiley also publishes its books in a variety of electronic formats. Some content that appears in print may not be available in electronic books. For more information about Wiley products, visit our web site at www.wiley.com.

Library of Congress Cataloging-in-Publication Data

Fischer, Robert, 1942 June 17–

Candlesticks, Fibonacci, and chart pattern trading tools : a synergistic strategy to enhance profits and reduce risk with CD-ROM / Robert Fischer, Jens Fischer.

p. cm.

ISBN 0-471-44861-3 (hard : CD-ROM)

1. Investments. 2. Securities. 3. Investment analysis. I. Fischer, Jens. II. Title.

HG4521.F584 2003

332.63'2042—dc21

2003006623

Printed in the United States of America.

10 9 8 7 6 5 4 3 2 1



abcBourse.ir



@abcBourse_ir

مرجع آموزش بورس



باز نشر :

This book is written for all the traders worldwide who contacted us on our Web site www.fibotrader.com and asked for advice.

This book contains a great deal of essential information for successful trading, but the necessary discipline and patience can only come from you.

We thank all those traders and friends who have provided help, criticism, and ideas over the past 20 years. We hope that this book will start a new wave of fruitful discussion that will benefit all of us.



HYPOTHETICAL PERFORMANCE RESULTS HAVE MANY INHERENT LIMITATIONS, SOME OF WHICH ARE DESCRIBED BELOW. NO REPRESENTATION IS BEING MADE THAT ANY ACCOUNT WILL OR IS LIKELY TO ACHIEVE PROFITS OR LOSSES SIMILAR TO THOSE SHOWN. IN FACT, THERE ARE FREQUENTLY SHARP DIFFERENCES BETWEEN HYPOTHETICAL PERFORMANCE RESULTS AND THE ACTUAL RESULTS SUBSEQUENTLY ACHIEVED BY ANY PARTICULAR TRADING PROGRAM.

ONE OF THE LIMITATIONS OF HYPOTHETICAL PERFORMANCE RESULTS IS THAT THEY ARE GENERALLY PREPARED WITH THE BENEFIT OF HINDSIGHT. IN ADDITION, HYPOTHETICAL TRADING DOES NOT INVOLVE FINANCIAL RISK, AND NO HYPOTHETICAL TRADING RECORD CAN COMPLETELY ACCOUNT FOR THE IMPACT OF FINANCIAL RISK IN ACTUAL TRADING. FOR EXAMPLE, THE ABILITY TO WITHSTAND LOSSES OR TO ADHERE TO A PARTICULAR TRADING PROGRAM IN SPITE OF TRADING LOSSES ARE MATERIAL POINTS WHICH CAN ALSO ADVERSELY AFFECT ACTUAL TRADING RESULTS. THERE ARE NUMEROUS OTHER FACTORS RELATED TO THE MARKETS IN GENERAL OR TO THE IMPLEMENTATION OF ANY SPECIFIC TRADING PROGRAM WHICH CANNOT BE FULLY ACCOUNTED FOR IN THE PREPARATION OF HYPOTHETICAL PERFORMANCE RESULTS AND ALL OF WHICH CAN ADVERSELY AFFECT ACTUAL TRADING RESULTS.

The following figures in this book are related to this disclaimer: 4.1, 4.5, 4.13, 4.14, 4.15, 4.20, 4.22, 4.27, 4.28, 4.48, 5.24, 5.25, 5.26, 5.27, 5.28, 5.29, 5.31, 5.34, 6.1, 6.2, 6.3, 6.4, 6.5, 6.6, 6.7, 6.8, 6.9, 6.13, 6.18, 6.21, 6.22, 6.23, 6.24, 6.25, 6.26, 6.27, 6.28, 6.29, 6.30, 6.31, 6.32, 6.33, 6.34, 6.35, 6.36, 6.37.



PREFACE

Many investors are unhappy with the performance of investment advisors and funds in the past couple of years and want to make their own trading decisions, using the analytic tools and the advice they have accumulated. This book presents easy, reliable trading tools, together with the trading rules to apply them to real-time trading.

Many investment strategies have been presented in books, market letters, and other media. In this book, we describe those tools that appear to work best, and we integrate them into a manageable and understandable trading strategy. Combining different strategies correctly can improve every investor's chances of success under different market conditions. Most importantly, we concentrate on strategies that every experienced investor can easily understand and execute with the WINPHI charting program that is provided on a CD-ROM at the end of this book.

With all the sophisticated computer models that are available, you might think that investing and making money would be getting easier. But just the opposite has happened. At no time in history has so much money been lost so fast, and not only the small investors have suffered. The big investment companies also have had unimpressive performances even though presumably they had all the necessary tools to beat the markets. This clearly shows that crunching numbers with a computer does not ensure success. For many years, we have concentrated on pattern recognition, a technique with proven reliability even when computers are not available.



Money is not made only by finding good entry points in different stocks, stock index futures, financial futures, or commodities. Making money is a strategic game, where it is important to work with stop-loss and profit targets. Traders make money through systematic investing. Then they must apply the same concepts to different products to gain the benefits of diversification.

Being well diversified with a systematic trading approach means that traders are unlikely to make as much money as they would if they put all of their investment money in one hugely successful product. But it makes the investment safer. Millions of investors made and lost a fortune by betting on high-tech companies. Although they bought correctly, they did not know when to sell. This book should help you avoid ever making that kind of mistake again.

Investing systematically has to be learned. Many times, it means executing trading signals at a loss, often when market letters, media, or other experts express the opposite opinion. To be comfortable investing against common opinion is crucial for success, but this is possible only for investors who can trust their trading approach. We hope that with the information in this book, many investors will learn to make successful trading decisions independently from any other published information.

Making money with a systematic approach requires obeying the following rules:

- A systematic trading approach, tested on historical data, should be executed with precision and accuracy (if possible, a computer should generate the signals).
- Although we concentrate on pattern recognition, candlesticks, and Fibonacci ratios, other tested strategies should work as well.
- The portfolio should have 5 to 10 products that are all analyzed using the same trading approach.
- Long and short signals should be allowed.
- Each position should be protected with a stop-loss.
- The profit target should be known once the position is entered.
- Each product should have a historically good trading range.



- Each trading strategy should perform in real-time trading according to the philosophy behind the trading concept. For example, a long and flat strategy cannot make money in bear market conditions, but it should make money in bull markets.

The first two chapters of *Candlesticks, Fibonacci, and Chart Pattern Tools* briefly set forth the psychology and philosophy of successful trading. In Chapter 3, we introduce the basic concepts of the Fibonacci analysis, candlesticks, and chart patterns. Experienced traders can skip these preliminaries and go on to Chapter 4, where we explain how to apply different trading concepts.

The PHI-ellipse is discussed in Chapter 5. We show how it can be successfully applied to real-time intraday trading. Although the WIN-PHI program can work with intraday ASCII data as well, it is very slow. The interested trader can go to our Web site (www.fibotrader.com) and sign up for a free trial period, to obtain an online trading experience. We do not offer fully automated trading approaches, but we introduce readers to some new ways to approach the market.

Finally, in Chapter 6, we combine concepts to demonstrate that traders can improve their profit chances while reducing their risks.

Although the fascination as well as the beauty of graphic trading tools lies in watching their development from day one, it is difficult to have the discipline to wait until Fibonacci price or Fibonacci time goals are reached. Succumbing to the temptation of taking profits a little bit earlier or placing protective stops a little wider could dilute the trader's overall performance profile.

The software has been carefully tested. A *User Manual* for the program on the CD-ROM is included as an Appendix of this book, to help users get started in applying all of the charting tools. The concepts in this book are thoroughly presented and include detailed examples. We hope that readers find our ideas as inspiring, enlightening, useful, and exciting, as we do ourselves.

ROBERT FISCHER
JENS FISCHER

Zug, Switzerland, 2003





abcBourse.ir



@abcBourse_ir

مرجع آموزش بورس



بازنشر :

CONTENTS

CHAPTER 1	TRADING PSYCHOLOGY AND INVESTOR BEHAVIOR	1
CHAPTER 2	THE MAGIC FIGURE THREE	7
CHAPTER 3	BASIC PRINCIPLES OF TRADING STRATEGIES	9
	Fibonacci Analysis	9
	Candlestick Analysis	24
	Chart Pattern Analysis	32
	Trend Lines and Trend Channels	41
CHAPTER 4	APPLICATIONS OF TRADING STRATEGIES	45
	Double Tops and Double Bottoms	45
	Fibonacci Price Corrections	52
	Fibonacci Price Extensions	67
	Candlestick Chart Patterns	77
	3-Point Chart Patterns for Trend Reversals	88
	PHI-Channel Applications	108
CHAPTER 5	PHI-ELLIPSES	115
	Basic Features and Parameters of PHI-Ellipses	116
	Working with PHI-Ellipses on Daily Data	132
	PHI-Ellipses on Constant Scales	150
	Working with PHI-Ellipses on Intraday Data	155
	Reliability of PHI-Ellipses Reconsidered	162



CHAPTER 6 MERGING CANDLESTICKS, 3-POINT CHART PATTERNS, AND FIBONACCI TOOLS	167
Fibonacci Price Correction Levels	168
Fibonacci Price Extensions	187
Support and Resistance Lines	195
PHI-Ellipses	207
Summary	218
SOME FINAL REMARKS	221
TUTORIAL	227
LIST OF ABBREVIATIONS	229
DISCLAIMER	231
USER MANUAL WINPHI GETTING STARTED	233
INDEX	251



CANDLESTICKS, FIBONACCI, AND CHART PATTERN TRADING TOOLS



abcBourse.ir



@abcBourse_ir

مرجع آموزش بورس



باز نشر :



abcBourse.ir



@abcBourse_ir

مرجع آموزش بورس



بازنشر :

1

TRADING PSYCHOLOGY AND INVESTOR BEHAVIOR

The market price of a stock at any exchange never represents the company's fair value. The stock instead is trading either above or below that valuation. Over the past couple of years, the potential discrepancy between market capitalization and fair value became painfully obvious to investors. Supported by analysts' unrealistic price forecasts, many high-tech stocks reached untenable high prices and then, in some instances, became worthless because there was no *real* value behind these companies.

In general, the market price fluctuates higher or lower around the fair value, depending how the market sentiment values the company.

GUIDELINES FOR INVESTORS

In the following sections, we list some rules that can help investors improve their investment decisions. These guidelines come from our experience and are not necessarily based on new theories.



1. *Know Yourself*

If you start sweating when you watch the price swings of a product you have invested in, you either have the wrong trading concept, are in the wrong products, or your positions are too big.

2. *Put Your Ego Aside*

The biggest losses happen after investors make their first big profits. If you accumulate profits with a proven, tested investment strategy, you can pride yourself on its success.

However, if you make profits without an investment strategy, you may lose not only all your profits but your total investment. Unexpected price moves do not have to mean big losses; they occur because investors work with the wrong trading concept.

3. *Hoping and Praying Do Not Guarantee Success*

Many traders keep repeating the same mistake: They take small profits and let the losses run. The main reason to work systematically with an investment concept is to get the best average performance. This requires placing a stop-loss with *every* trading position and calculating the profit target when opening a position.

Hoping that losses will become profits by waiting a “little bit longer” is gambling. It might be appropriate once in a while, but in the long run, it ruins every account.

4. *Investors Must Learn to Live with Losses*

It is easy to enjoy profits, but everyone hates losses. A market price that drops below the entry price is not the only reason for a loss. If a position with a 100 percent profit is liquidated at the entry price, this is also a big loss in the account, although it may not seem as damaging.

5. *Never Double Your Losses*

Dollar-cost averaging is one of the best strategies for investors if they execute it systematically as part of a long-term strategy.



Almost all huge bankruptcies in trading companies worldwide happened because they doubled up losing positions. Hoping to recover losses through additional leverage never works unless someone is really lucky.

6. *Know Your Pain Level*

Investors create their biggest problems when they change their investment strategy without sufficient reason. The trouble begins when traders jump from one trading strategy to another to follow the short-term sentiment, mainly because a product seems to have changed.

Each investment strategy has its advantages and disadvantages. Someone who has expertise in picking stocks should continue to use this approach, despite the risk of big drawdowns. A perfect trading concept does not exist, unless someone has discovered a niche product and keeps quiet. At the same moment that this niche market becomes common knowledge, the profit potential disappears.

Each investment strategy has a predetermined pain level that investors can identify. It is important to know this pain level before executing an investment strategy.

7. *Diversify the Risk*

No matter how promising the future of a product may seem, diversify the risk. Many traders profitably trade the same product every day and are especially successful in intraday trading. But these traders are disciplined and have specific product knowledge that is not available to most people.

In general, diversifying the risk with a systematic trading approach will result in a much more stable equity curve than investing in a single product.

8. *Making Money by Trading Is Hard Labor*

Many people believe that that it is easy to make money by investing in stocks, bonds, stock index futures, or commodities.

The opposite is true. Investors who show quick profits through trading either have inside information or are remarkably lucky. Average investors have neither of these advantages.



All traders must develop a personal profile of risk preference and find a systematic trading style that fits the profile. Then they have to execute it. Months or years of systematic trading may be necessary before real-time trading results confirm that the trading concept works.

9. *Intuition versus Execution of a Tested Trading Concept*

All of the information that comes over the tickers, from newsletters, and through the Internet is already old when we receive it. There will always be someone with faster access who can take advantage of that information. Speculating with this “old” information is dangerous.

Trading concepts that have been tested and have good historical track records on paper provide valid information only if the advisor is willing to share how the trading concept works.

Real-time trading records are only reliable if market behavior does not change. Many of the successful fund managers in the 1980s did less well in the 1990s because the market patterns were very different. Investors must be highly skilled to identify trading concepts that did not perform well in the past but will perform well in the future.

10. *The Importance of a Trading Plan*

The secret of success on the exchanges is not to make money fast, but to make it consistently.

One of the most difficult accomplishments for traders is to create a portfolio that builds up equity over the long term, independently of market conditions. To reach this goal, it is essential to work with a reliable investment strategy and to guard against being greedy.

11. *Feel Comfortable with Your Trading Strategy*

Successful traders begin the morning with a trading concept that they can use comfortably for executing trading signals throughout the day, no matter what the markets are doing.

Feel good about your trading strategy as long as the real-time trading results are in line with the historical test results. If the maximum drawdown gets bigger than the drawdown of the historical test results, reevaluate the trading concept.



12. Nothing Is More Important than Discipline

Discipline is always the most important attribute of successful traders. Many traders fail or have limited success because they cannot control their emotions and execute their established trading strategy in any given market situation.

13. Value of Available Trading Concepts

Many worthwhile trading concepts are available. But none of them will always make money. An effective trading concept does not have to be difficult, but it must be executable. The trader has to believe in it and be willing to trade it even after a string of losses.





abcBourse.ir



@abcBourse_ir

مرجع آموزش بورس



بازنشر :

2

THE MAGIC FIGURE THREE

In presenting Fibonacci Trading tools, candlesticks, and chart price patterns, we concentrate on the ones that have a high analytical value and can be combined with each other. Our goal is to avoid information overflow, while providing adequate detail, because all of the strategies can be important in different market situations.

A key question is whether all of these patterns have a common denominator. The answer is a definitive “yes”—all of them include the figure three:

- Three waves in price extensions.
- Three waves as the basic structure of the PHI-ellipse.
- Three peaks and valleys in triple top/bottom chart patterns.
- Three peaks and valleys in head and shoulder formations.
- Three peaks (or valleys) in symmetrical, ascending, or descending triangles.
- Three rising valleys and three falling peaks formations.
- Three peaks or valleys in rectangles, flags, wimples, wedges, and other chart formations.



Traders who analyze only chart patterns that feature the figure three and eliminate all other formations may lose some price moves, but their overall analysis will be safer and more accurate because they will know what to look for on the price charts. The biggest advantage of this approach is that most investors can identify patterns and execute corresponding trading strategies with or without a computer.

Figure 2.1 shows eight relevant chart patterns based on the figure three.

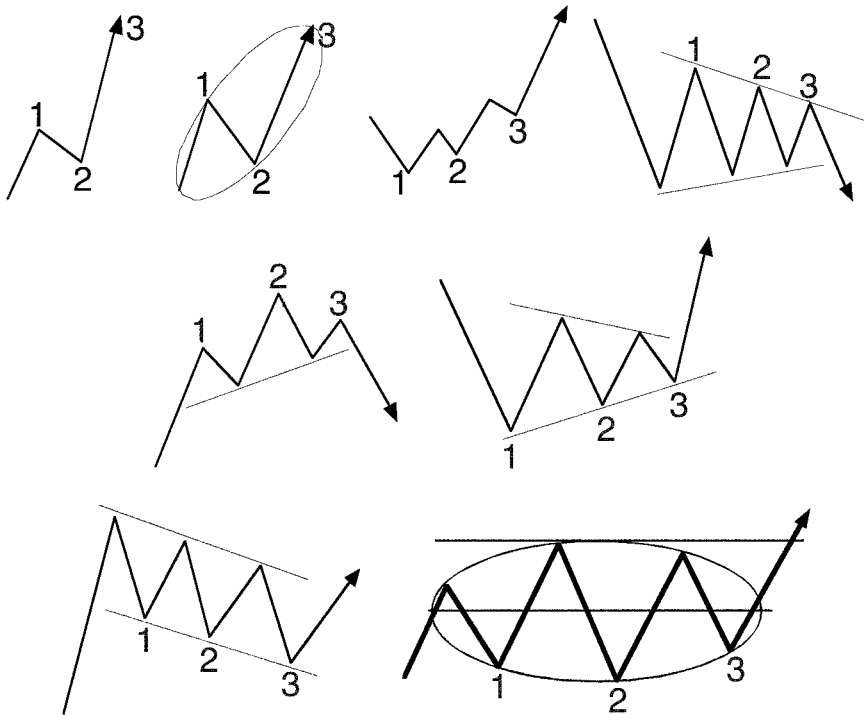

Figure 2.1 Chart patterns including the magic figure “three.”

As explained in the following chapters, the PHI-ellipse is the best trading instrument for daily and intraday trading. What makes this trading tool interesting and unique is its ability to surround most chart patterns that include the figure three. Whenever we can integrate chart patterns into the PHI-ellipse, it allows us to work with only one trading tool. This is why in this book we focus on trading tools that have similar characteristics, and many times we identify the same turning points or breakouts, but from a different perspective.

3

BASIC PRINCIPLES OF TRADING STRATEGIES

This chapter focuses on the key principles of four successful trading strategies: (1) Fibonacci principles, (2) candlestick formations, (3) chart patterns, and (4) trend lines and trend channels.

The analysis is simple and concise, but nonetheless provides readers with all of the tools and insight required to apply the trading strategies discussed later in the book.

FIBONACCI ANALYSIS

Fibonacci (1170–1240), an Italian merchant, became famous in Europe because he was also a brilliant mathematician. One of his greatest achievements was to introduce Arabic numerals as a substitute for Roman numerals.

He developed the Fibonacci Summation Series, which runs as follows:

1, 1, 2, 3, 5, 8, 13, 21, 34, 55, 89, 144, . . .



The mathematical series tends asymptotically (approaches slower and slower) toward a constant ratio.

This is an irrational ratio, however; it has a never-ending, unpredictable sequence of decimal values stringing after it and can never be expressed exactly. If each number, as part of the series, is divided by its preceding value (e.g., $13 \div 8$ or $21 \div 13$), the operation results in a ratio that oscillates around the irrational figure 1.61803398875 . . . , being higher than the ratio one time and lower the next. We will never know, into infinity, the precise ratio (even with the powerful computers of our age). For the sake of brevity, we refer to the Fibonacci ratio as 1.618 and ask the reader to keep the margin of error in mind.

This ratio had begun to gather special names even before Luca Pacioli (1445–1514), another medieval mathematician, called it “divine proportion.” Among its contemporary names are “golden section” and “golden mean.” Johannes Kepler (1571–1630), a German astronomer, referred to the Fibonacci ratio as one of the jewels in geometry. Algebraically, it is generally designated by the Greek letter PHI:

$$\text{PHI} = 1.618$$

And it is not only PHI that is interesting to scientists (and traders). If we divide any number of the Fibonacci summation series by the number that follows it (e.g., $8 \div 13$ or $13 \div 21$), the series asymptotically gets closer to the ratio PHI' with

$$\text{PHI}' = 0.618$$

This is a remarkable phenomenon—and a useful one when designing trading tools. Because the original ratio PHI is irrational, the reciprocal value PHI' to the ratio PHI necessarily is also an irrational figure, which means that again there is a slight margin of error when calculating 0.618 in an approximated, shortened way.

We have discovered a series of plain numbers that can be applied to science by Fibonacci. Before we try to use the Fibonacci summation series to develop trading tools, it is helpful to consider its relevance in nature. It is then only a small step to reach conclusions about



the relevance of the Fibonacci summation in international market movements, whether in currencies or commodities, stocks, or derivatives. Humans subconsciously seek the divine proportion, which is nothing but a constant and timeless striving to create a comfortable standard of living.

The Fibonacci Summation Series in Nature and Geometry

It is remarkable how many constant values can be calculated using Fibonacci's sequence, and how often the individual numbers of the sequence recur in myriad variations.

This is not just a numbers game, however; it is the most important mathematical representation of natural phenomena ever discovered. Generally speaking, the Fibonacci summation series is nature's law, and it is a part of the aesthetics found in any perfect shape or curve.

Fibonacci discovered how nature's law related to the summation series when he proposed that the progeny of a single pair of rabbits increased in a repeatable pattern:

Suppose there is one pair of rabbits in January, which then breed a second pair of rabbits in February, and, thereafter, these offspring produce another pair every month. The mathematical problem is to find how many pairs of rabbits there will be at the end of December.

To solve this little algebraic puzzle, we tabulate the data in four columns:

1. The total number of pairs of breeding rabbits at the beginning of each given month.
2. The total number of pairs of nonbreeding rabbits at the beginning of each month.
3. The total number of pairs of rabbits breeding during each month.
4. The total number of pairs of rabbits that have been bred at the end of 12 months.



Table 3.1 shows the progression to the total number of rabbits, based on the four criteria.

Table 3.1 Progeny of a Single Pair of Rabbits

Month	(1)	(2)	(3)	(4)
January	0	1	0	1
February	1	0	1	2
March	1	1	1	3
April	2	1	2	5
May	3	2	3	8
June	5	3	5	13
July	8	5	8	21
August	13	8	13	34
September	21	13	21	55
October	34	21	34	89
November	55	34	55	144
December	89	55	89	233

Source: *The New Fibonacci Trader Workbook*, by Robert Fischer (New York: Wiley, 2001), p. 20.

Each column contains the Fibonacci summation series, formed according to the rule that any number is the sum of the pair of immediately preceding numbers.

One needs only to look at the beauty of nature to appreciate the relevance of the Fibonacci ratio PHI as a natural constant. The number of axils on the stems of many growing plants and the number of petals on flowering plants provide many examples of the Fibonacci ratio and underlying summation series. The following illustrations depict some interesting applications of this mathematical sequence.

Fibonacci Numbers Found in Plants

The sneezewort, a Eurasian herb, is an ideal example of the Fibonacci summation series in nature, for every new branch springs from the axil and more branches grow from a new branch.



Adding the old and the new branches together reveals a number of the Fibonacci summation series in each horizontal plane. Figure 3.1 illustrates the count.

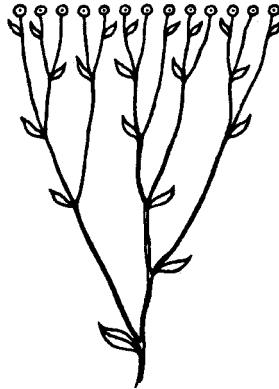

Figure 3.1 Fibonacci numbers found in the flowers of the sneezewort. *Source: The New Fibonacci Trader Workbook, by Robert Fischer (New York: Wiley, 2001), p. 4.*

According to the same algebraic principle, we can easily identify Fibonacci summation series in plant life (so-called golden numbers) by counting the petals of certain common flowers. Taking the iris at 3 petals, the primrose at 5 petals, the ragwort at 13 petals, the daisy at 34 petals, and the michalmas daisy at 55 (and 89) petals, one must question whether this pattern is accidental or a particular natural law.

Rule of Alternation in the Sunflower

The beautiful curving lines of the sunflower have existed naturally throughout thousands of centuries, and mathematicians have made them a subject of study for hundreds of years.

The sunflower has two sets of equiangular spirals superimposed and intertwined, one turning clockwise and the other turning counterclockwise. There are 21 clockwise and 34 counterclockwise spirals. Both numbers are part of the Fibonacci summation series. The order is closely related to the rule of alternation, which Elliott used in his wave principles to explain human behavior (see Figure 3.2).

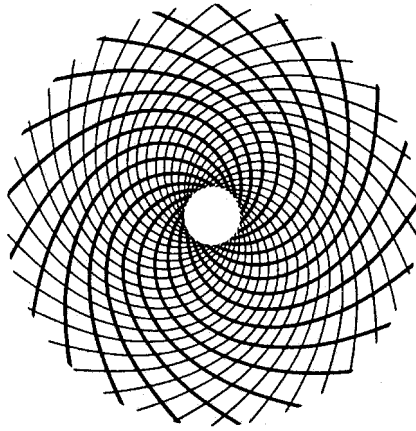

Figure 3.2 The rule of alternation shown in the sunflower. Source: *The New Fibonacci Trader Workbook*, by Robert Fischer (New York: Wiley, 2001), p. 5.

Geometry of the Golden Rectangle and the Golden Section

The famous Greek mathematician Euclid of Megara (450–370 B.C.) was the first scientist to write about the golden section and to focus the analysis of a straight line.

The more complex structure of the geometry of a golden rectangle is shown in Figure 3.3. The ratio of the long side of the rectangle divided by the short side of the rectangle has the proportion of the Fibonacci ratio 1.618.

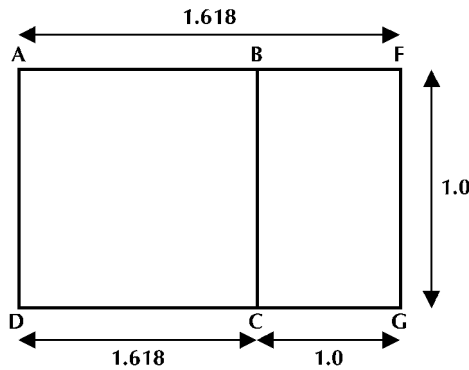

Figure 3.3 Geometry of the golden rectangle. Source: *The New Fibonacci Trader Workbook*, by Robert Fischer (New York: Wiley, 2001), p. 7.

Parthenon Temple in Athens

The proportions of the Parthenon temple in Athens bear witness to the influence of the golden rectangle as well as the golden section on Greek architecture.

The proportions of the Parthenon temple fit exactly into a golden rectangle; its total width is exactly 1.618 times its height (see Figure 3.4).

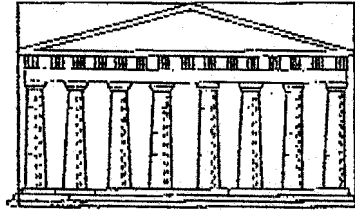

Figure 3.4 Parthenon temple in Athens. *Source: The New Fibonacci Trader Workbook*, by Robert Fischer (New York: Wiley, 2001), p. 7.

Other geometric curves that are important to humankind are plentiful in nature. The most significant to civilization include the horizon of the ocean, the meteor track, the parabola of a waterfall, the arc that the sun travels in the sky, the crescent moon, and the flight of a bird.

Many of these natural curves can be geometrically modeled using ellipses. The latter finding leads into a brief description of trading tools that use the Fibonacci ratio. A basic knowledge of the construction and functions of these tools is necessary to understand the trading strategies that are introduced later in this book.

Introduction of the Fibonacci Trading Tools

Corrections

In general, for corrections with Fibonacci-related trading tools, an impulse wave that defines a major market trend upward or downward will have a corrective wave before the next impulse wave reaches new territory. This occurs in both bull market and bear market conditions.

Analysis would be easy if we could detect a single general pattern of corrections. The problem is that there can be many more price

patterns than impulse waves in the commodities, futures, stock index futures, stocks, or currency markets. Markets move sideways for a longer period than an impulse wave appears.

We can never predict which of the next waves will be an impulse wave instead of another false move in continuation of a sideways market. Therefore, every serious trading approach using corrections has to be designed to survive even the longest sideways market correction phase.

No market pattern can assure a profitable trade. At any time, we can be in a correction of an impulse wave or at the beginning of a new impulse wave.

Trading with corrections is a trend-following strategy. It is based on the assumption that after a correction of an impulse wave up or down, the next impulse wave will follow in the direction of the first impulse wave after the correction is finished. Thus, we generally expect a minimum of a three-swing price move, and in many cases, this assumption is correct. Therefore, working with corrections is a valid investment strategy, and it is discussed in detail later in this book. Corrections work equally well long or short, to the upside or downside of the markets. The worst thing that can happen in trending markets is that the market may run away without correcting enough and without leaving a valid signal. Markets moving sideways involve the risk of the trader getting stopped out in a streak of losing trades if the strategy's parameters are too restrictive.

Trading with corrections is a short-term strategy. The goal is to have many trades, of which a large number are profitable. Likewise, there should be a low number of losing trades, and these should be small losses.

Corrections are closely related to the Fibonacci ratios through the swing size and the volatility of a product. Which ratio to choose depends on the product and the time intervals selected. Weekly data might need different ratios from daily or intraday data. The safest way to find the best ratio for products and time spans is to test them on historical data with a computer.

The most common approach to working with corrections in research and practical trading is to relate the size of a correction to a percentage of a prior impulse wave.

For Fibonacci's PHI, the following prominent percentages of possible market corrections can be derived directly from the ratios 0.618, 1.000, and 1.618 of the PHI series:



- 38.2 percent is the result of the division $0.618 \div 1.618$.
- 50.0 percent is the transformed ratio 1.000.
- 61.8 percent is the result of the immediate ratio $1.000 \div 1.618$.

Figure 3.5 shows the different risk profiles when trading alternative percentages of corrections with stop-loss protection.

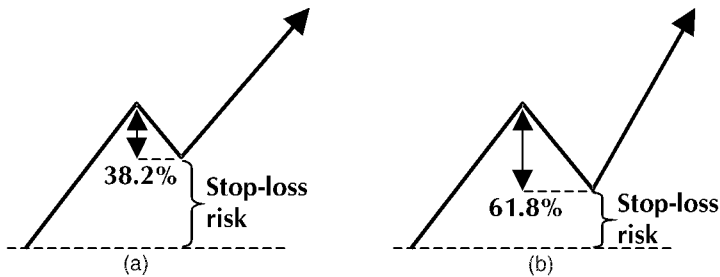

Figure 3.5 Different stop-loss risk profiles on investments into a correction of 38.2 percent and a correction of 61.8 percent.

Forecasting the exact size of a correction is an empirical problem. Investing after a correction of just 38.2 percent might be too early, whereas waiting for a correction of 61.8 percent might result in completely missing a strong trend. But no matter what corrections are considered, traders should focus on the PHI-related sizes.

Price Extensions in 3-Wave Patterns

Price extensions are exuberant price movements that result from runaway markets, opening gaps, or limit moves, up or down, at high volatility. Most extensions occur when unexpected news, such as weather information, crop reports, or interest rate announcements by the Federal Reserve Board, reverse major market trends within seconds.

When news runs counter to investors' expectations, market situations emerge with strong trading potential. However, investors can only take advantage of these situations if they follow sensible, definitive rules in carrying out analysis. Extensive market moves can be very dangerous for investors who get caught by surprise with a wrong position in the marketplace.

Extensions take place primarily in the third wave of a 3-wave price pattern. In a regular 3-wave pattern in an uptrend, the correction does not go lower than the bottom of wave 1. In extensions out of a bear trap formation of irregular bottoms, the correction can go lower than the low of the first impulse wave (opposite in a bull trap). The two basic chart formations for price extensions are illustrated in Figure 3.6.

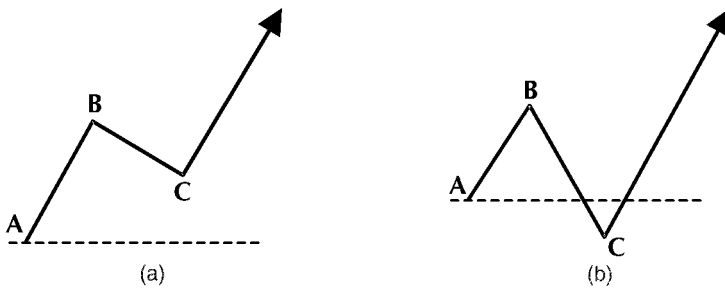

Figure 3.6 Extensions out of a regular 3-wave pattern and a bear trap chart formation.

Exploring price extensions means investing against major trend directions. Working with extensions also suggests that an investor is looking for quick profits by taking advantage of imbalances in the marketplace. Therefore, it is important to know in advance not only when to enter a position, but also when to exit it. Entry rule, stop-loss rule, and profit target always must be integrated to achieve long-term investment strategies that are consistently profitable.

Three consecutive analytical steps are needed to calculate price targets in price extensions of the third wave out of a 3-wave chart formation:

1. A minimum swing size has to be defined for the sizes from peak to valley (or valley to peak) of the first impulse wave of the 3-wave pattern.
2. The swing size has to be multiplied by the Fibonacci ratio 1.618.

- The resulting value is added to the size of the initiating swing to define the price target.

Figure 3.7 illustrates these steps.

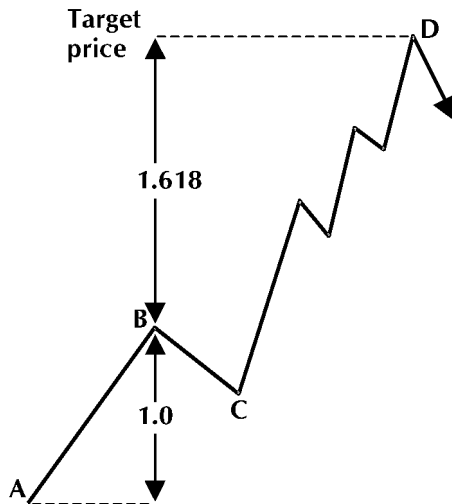

Figure 3.7 Extension in the third wave of a 3-wave pattern uptrend. Target level measured by the Fibonacci ratio $\text{PHI} = 1.618$.

Sophisticated investors who want to explore fast markets can easily follow the basic principles of extensions in 3-wave patterns and extend the rules into 5-wave price patterns.

Price Extensions in 5-Wave Patterns

When analyzing price extensions in a 5-wave pattern, we look for an additional parameter from the Fibonacci summation series to confirm our price target calculation for extensions out of a 3-wave pattern based on the 1.618 ratio.

To analyze a 3-wave price pattern, we multiply the size of the first impulse wave by the Fibonacci ratio 1.618. The product is then added to the swing size of the initial move to calculate the Fibonacci price target line. It is at this Fibonacci price target line that we expect the third wave to reverse.

Because there are usually more than three waves in a trending market, we need to modify our calculations for the Fibonacci target price. The most common price pattern has at least five waves: three impulse waves and two corrective waves.

A target price line in a typical 5-wave market price pattern is shown in Figure 3.8.

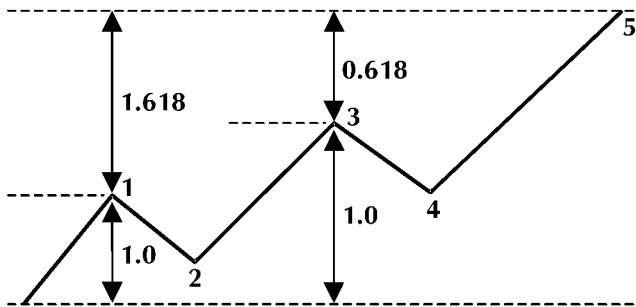

Figure 3.8 Calculation of Fibonacci price target in a regular 5-wave move.

In a regular 5-wave move in an uptrend, the price target line for the end of wave 5 is calculated by multiplying the amplitude of wave 1 by the Fibonacci ratio 1.618, and then multiplying the amplitude from the bottom of the wave to the top of wave 3 by the reciprocal value to the Fibonacci ratio 0.618. In a downtrend pattern, we also multiply the initial swing size by 1.618 and multiply the amplitude from the high of wave 1 to the low of wave 3 by the ratio 0.618.

By combining the two calculations—using ratios 0.618 and 1.618—we can precalculate the end of wave 5 at the same price, given that the market moves in a regular price pattern as described.

In practical terms, however, this is seldom the case. Instead of finding the same price level with both ratios, we get two price levels that are closer together or wider apart, depending on the amplitudes of wave 1 and wave 3. We find an upper and lower price target, defined as a Fibonacci price target band.

Do we know whether this price forecast will ever be reached? Absolutely not. But we know in advance whether the price band calculated at 1.618 times the size of wave 1 and at 0.618 times the distance from the top or bottom of wave 1 to the bottom or top of wave 3 will be close together or far apart. If the price target band is far apart, we do not use it for the analysis. A band is worth consideration if its

upper and lower levels are close together in relation to the underlying swing size of the initial move of the first impulse wave.

PHI-Ellipses

The PHI-ellipse is an almost unknown trading tool that is closely related to the Fibonacci ratios. This tool surrounds price moves and makes investors' behavior visible for analysis on any kind of data.

Because swing formations are easy to identify and integrate into computerized trading environments, traders or managers investing in smaller accounts often use peak-and-valley formations. Many profitable trades are possible, as long as there are regular wave patterns and each impulse wave defines new highs or new lows by a wide margin.

In multiple corrections with many false breakouts, however, swing systems have little use because exogenous factors like slippage and commission can consume all of the system's small profits.

Adding the time element to the analysis of market moves immediately changes the conditions by filtering out noise and increasing the stability of investment strategies. This is where PHI-ellipses come in.

Working with PHI-ellipses can be difficult. The basic structure is simple, but because price patterns may change over time, the final shape of a PHI-ellipse also may vary. What makes PHI-ellipses so interesting is that they can identify underlying structures of price moves and can circumvent price patterns. When a price pattern changes, the shape of the PHI-ellipse circumventing the respective market price pattern changes, too. We find long and short PHI-ellipses, fat and thin PHI-ellipses, and even PHI-ellipses that are flat or have a steep angle. There are very few market price moves that do not follow the pattern of the PHI-ellipse.

PHI-ellipses are related to the Fibonacci ratio. Generally speaking, the ratio of major axis A to minor axis B defines the shape of an ellipse. Ellipses are turned into PHI-ellipses whenever the ratio of major axis to minor axis is a member number of the PHI series. To make PHI-ellipses work as devices for chart analysis, we have applied a (proprietary) transformation to the mathematical formula that describes the shape of the ellipse. We still consider the ratio of the major axis A to the minor axis B of the ellipse, but in a Fischer-transformed way.

PHI-ellipses are instruments for investments that represent a countertrend to market actions. Thus, we observe whether a price move stays within a PHI-ellipse and invest accordingly if a price move breaks out of a PHI-ellipse at the very end. To draw a PHI-ellipse correctly,



three points are necessary—the starting point and two side points. It is possible to draw the PHI-ellipse if the second impulse wave is at least as long as the first impulse wave. This principle is shown in Figure 3.9.

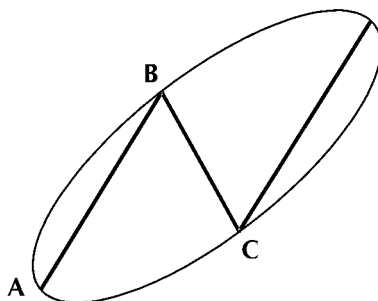

Figure 3.9 PHI-ellipse circumventing a 3-wave price pattern.

After identifying the points A, B, and C in the typical 3-wave swing, we can position the PHI-ellipse around these points. Wave 1, from A to B, is an impulse wave. Wave 2, from B to C, is the corrective wave to the impulse wave. For wave 3, we expect a second impulse wave in the direction of the first impulse wave. This general pattern follows Elliott's Wave Principle and can be seen in every traded product, be it commodities, futures, stocks, or cash currencies.

The fundamental structure of the PHI-ellipse provides another way to analyze price moves. What makes it unique is that it is dynamic over time and follows price patterns as they develop. That is why it is necessary to be patient and wait—from the very beginning to the very end—until a price move stays within the PHI-ellipse. Traders can take action as soon as the market price moves out of the PHI-ellipse, but only if a price pattern runs completely inside until reaching the final point.

There are several ways to invest against the market trend at the end of the PHI-ellipse:

- Enter a position when the market price breaks the outside line of the PHI-ellipse.

- Enter a position based on a chart price pattern that forms at the end of the PHI-ellipse.
- Enter a position when the market price moves out of the outside line, which is parallel to the median line of the PHI-ellipse.

Selling at the end of a PHI-ellipse is recommended when the PHI-ellipse has an upward slope. Buying at the end of a PHI-ellipse is recommended when the PHI-ellipse has a downward slope.

An entry rule confirms trend reversals to the upside or downside at the end of a PHI-ellipse. The rule is set to the lowest low of the previous one, two, three, or four days for sell signals, and the highest high of the previous one, two, three, or four days for buy signals. The choice of entry rule depends on investors' risk preference and how early they want to be invested.

In the example shown in Figure 3.10, we choose the conservative option of a double confirmation by PHI-ellipse and trend channel. With this option, we may give up some of the profit potential that we could have realized with a more sensitive entry rule. On the other hand, we avoid losing trades in strong trending market conditions by staying in the trend as long as it lasts.

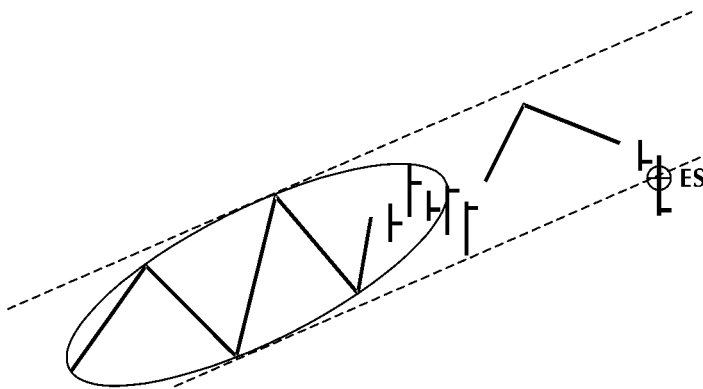

Figure 3.10 Short entry on a combination of PHI-ellipse and trend channel (ES: entry short).

As a standard rule, when three little PHI-ellipses can be surrounded by a bigger PHI-ellipse, it is often a signal of an important turning point (see Figure 3.11).

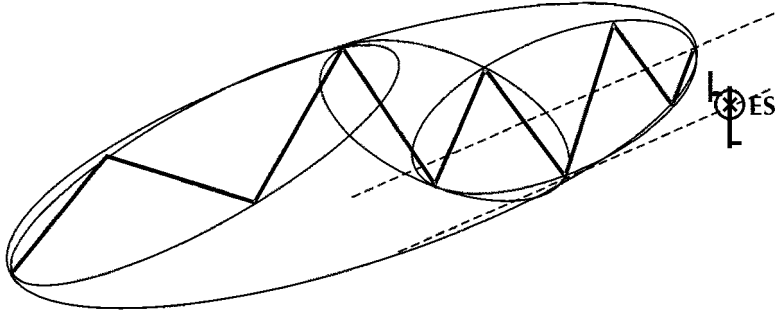

Figure 3.11 Short entry on a large PHI-ellipse circumventing three smaller PHI-ellipses (ES: entry short).

PHI-ellipses work on monthly, weekly, daily, and intraday charts. However, to avoid complicating the analysis at this point, we defer integrating PHI-ellipses on sets of intraday data and describe intraday samples in a later chapter.

Summary

In this section, we have explained the basics of three trading concepts: price corrections, price extensions, and PHI-ellipses. We have concentrated on these Fibonacci-related trading tools because they are easy to understand and combine well with the candlesticks and price patterns that are described next in this chapter.

The interested reader can find more detailed information in our book *The New Fibonacci Trader* (New York: John Wiley & Sons, 2001).

CANDLESTICK ANALYSIS

Even though the structure of candlesticks is different from that of bar charts, it is easy to combine candlesticks with the technical chart analysis. By focusing on the relationship between open and close prices, candlesticks show how market forces change during market

hours. This often indicates the short-term momentum in different products or markets.

In this section, we describe basic candlestick charting and chart analysis. We concentrate on the most meaningful patterns for traders.

Combining candlestick charts with Fibonacci trading tools and chart patterns is an effective strategy because every combination is based on the same principle: the analysis of investor behavior, as expressed through the Fibonacci ratios, candlesticks, or chart patterns.

Structure of Candlestick Charts

Candlestick charts are based on the same market data as regular bar charts but present that data in a different way. The components of candlestick charts are the opening price level, the closing price level, the high price, and the low price of any data compression rate, be it weekly, daily or intraday data. Figure 3.12 shows the composition of a candlestick.

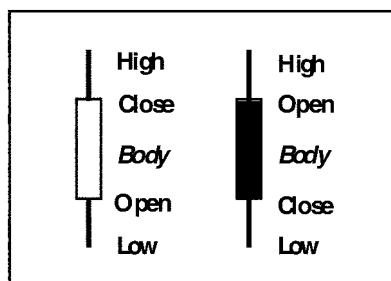

Figure 3.12 Constituents of candlesticks.

The relationship between the open price level and the close price level forms the body of the candlestick chart. If the close is below the opening, the body is black. If the close is above the opening, the body is white. The opening and closing price of every data compression—weekly, daily, or intraday—is, therefore, important for analysts who use candlestick charts.

The price moves above and below the candlestick body are called the “shadow.” Depending on how large the distance is between high and low of a price bar to the body of the candlestick, the shadows can be long or short.

In Figure 3.13, we compare a bar chart and a candlestick chart based on the same open, high, low, and close data.

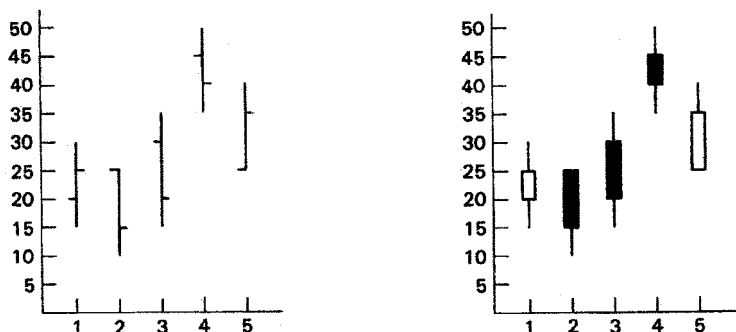

Figure 3.13 Bar charting technique and candlestick charting technique in comparison.

Analysis of Selected Candlestick Formations

Most candlestick formations identify either a slowdown in a market trend or a trend reversal. It is important to understand that there is a close relationship between reversal candlestick patterns and reversal patterns in the chart analysis. For example, a key-reversal day in the chart analysis can also be shown in the candlestick analysis by using a bullish belt-hold or a bearish belt-hold.

Traders like working with candlestick charts because they show investor behavior in a different, but simple, price picture that is easy to combine with other trading tools. Candlestick charts can be analyzed without any time lag, and investor behavior can be examined just by looking at the relationship between the open, high, low, and close at every price bar.

The following candlestick chart patterns are seen often and combine well with the Fibonacci trading tools. The interested reader will find many books that describe candlestick patterns in detail.

Hammer and Hanging Man

A candlestick chart pattern is called a hammer if it has a long shadow and a small body (black or white) that is very close to the high of the day. At the end of a downtrend, the hammer is considered a bullish reversal signal.

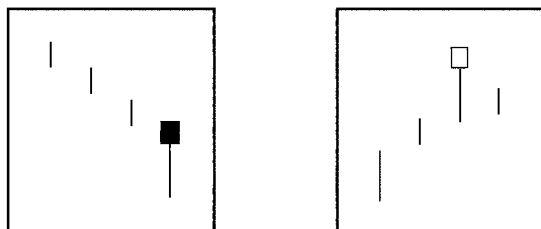

Figure 3.14 Hammer and hanging man.

Hammer and hanging man should both have a long shadow. Ideally, the shadow should be about three times as long as the body. The long shadow shows that the market price dropped very sharply after the opening and then recovered at the end of the trading session. The opening and closing price should be close together, which will result in a small body on the candlestick chart.

At the end of an uptrend, the same candlestick chart pattern is called a hanging man. The hanging man is also a reversal pattern. To get a sell signal, the market price should trade below the lowest low of the hanging man in the following days. It might be even safer to wait until the close of a day is below the lowest low of the hanging man candlestick pattern (see Figure 3.14).

Bullish and Bearish Belt-Hold

The bullish belt-hold is a candlestick formation with a white body, which means that the opening price was very low, the market started a rally, and the closing price is very high. The opposite holds true for the bearish belt-hold. In this case, the opening price is very high and the closing price is very low. The bigger the body in the belt-hold candlestick pattern, the more important is this pattern for a trend reversal.

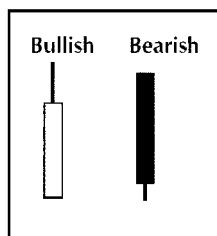

Figure 3.15 Bullish and bearish belt-hold.

If the opening price of the next day is higher than the bearish belt-hold candlestick pattern, it is likely that the market will go higher. On the other hand, if the opening price of the next day is below a bullish belt-hold, traders can expect that the market will continue to go lower (see Figure 3.15).

Bullish and Bearish Engulfing Pattern

While hammer and hanging man as well as bullish and bearish belt-hold are single candlestick formations (consist of one candlestick), the bullish and bearish engulfing patterns always need a pair of candlesticks to complete the pattern.

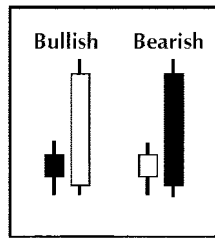

Figure 3.16 Bullish and bearish engulfing pattern.

The bullish engulfing pattern is a reversal pattern at the end of a downtrend. This formation is completed when a large white candlestick body completely covers a smaller black candlestick body from the previous day. It is not important that the big, white candlestick body covers the shadow of the previous day as well.

A bearish engulfing pattern is important at the end of an uptrend. In this case, a big black candlestick body covers a small white candlestick body of the previous day (see Figure 3.16).

Harami Pattern and Harami Cross

The harami pattern needs two candlesticks and is the exact opposite of the engulfing pattern. In the traditional bar chart analysis, the harami pattern is called an inside day.

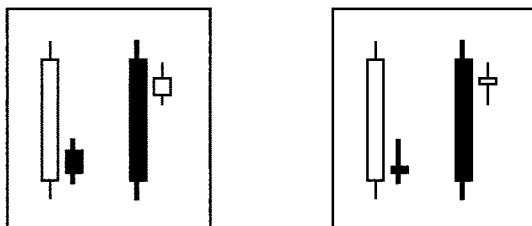

Figure 3.17 Harami pattern and harami cross.

The harami pattern has a small body (black or white) that fits completely into the big (black or white) body of the previous day. It is not important whether the shadow of today's small candlestick pattern goes higher or lower than the previous candlestick shadow. The harami pattern has greater importance if, at the end of a downtrend, today's small candlestick body is white, whereas the big candlestick body of the previous day is black. The reversal signal is even stronger when today's candlestick body is very small. The harami pattern can be a bullish signal after a downtrend or a bearish signal at the end of an uptrend.

The harami cross is a special kind of harami pattern. In this candlestick pattern, today's candlestick body is very small, which means that the opening and the closing price are almost identical (see Figure 3.17).

Doji Pattern

The doji pattern identifies when the momentum of markets is slowing down. Doji candlesticks have a very small body (opening and closing prices of the day are almost identical), and there is a long shadow either above or below the candlestick body.

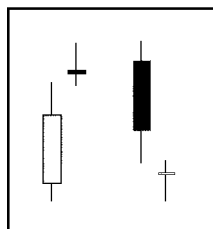

Figure 3.18 Doji pattern.

Doji patterns are only interesting at the end of longer upswings or downswings. They have more importance when there is an engulfing pattern on the following day (see Figure 3.18).

Piercing Pattern and Dark-Cloud Cover

The piercing pattern looks much like the bullish engulfing pattern and is only valid at the end of a downtrend. While in the bullish engulfing pattern, the large white body of today's candlestick covers the small black candlestick body of the previous day; the piercing pattern is similar.

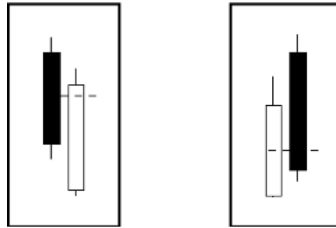

Figure 3.19 Piercing pattern and dark-cloud cover.

A valid signal with a piercing pattern is generated when today's big, white candlestick body covers at least 50 percent of the previous day's black candlestick body. The more the body of the piercing pattern covers the candlestick body of the previous day, the stronger is the reversal signal.

The candlestick formation of a dark-cloud cover is important as a reversal signal at the end of an uptrend. In this case, the big, black body of the dark-cloud cover has to cover at least 50 percent of the previous day's white candlestick body. The more the candlestick body of the dark-cloud cover pattern covers the candlestick body of the previous day, the stronger is the reversal signal (see Figure 3.19).

Morning Star and Evening Star

In a star candlestick formation, a small candlestick body (black or white) is separated through a price gap from the candlestick body of the previous day (see Figure 3.20).

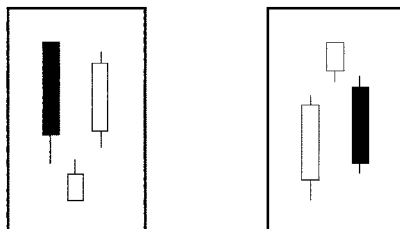

Figure 3.20 Morning star and evening star.

The body of the star can touch the shadow of the previous day's candlestick pattern, but it does not touch the body. If the star does not have a small body, but is a doji (opening and closing price are almost identical), the candlestick pattern is a doji star. Star and doji star are warning signals for an imminent trend reversal.

A morning star is a bottom reversal pattern formed by three candlesticks. The first candlestick has a big black body, for this is still a downtrend. The second candlestick is a star with a very small body that is below the previous candlestick and has no connection to the previous body. The third candlestick has a big, white body that should cover at least 50 percent of the big black body from two days ago. In the ideal form, the third candlestick body should trade with a gap to the body of the star of the previous day. Should the third candlestick be an engulfing pattern, this is also a valid trend reversal signal.

An evening star is a trend reversal pattern after a strong uptrend. This formation also has three candlesticks. The first has a long white body. The following candlestick is a star with either a black or white body that has no connection with the previous candlestick body. The third candlestick has a big black body that covers at least 50 percent of the big black body from two days earlier. Between the body of the star and the last big black body, there also should be a gap. If there is a bearish engulfing pattern, this constellation is a valid trend reversal signal as well.

Summary

When working with candlestick patterns, traders look for indications of short-term trend reversals. The unique structure of candlesticks makes them a convincing and easily managed charting technique.

Trend changes are much more visible on candlestick charts than on regular bar charts.

CHART PATTERN ANALYSIS

Analysts, investors, and traders often ask how to determine where a trend comes to an end. The Fibonacci trading tools and the candlestick patterns provide two significant ways to answer this question. Chart patterns are a third method for analyzing trends.

We try to integrate Fibonacci trading tools, candlestick patterns, and chart patterns because, as mentioned, they are all based on the most important element that moves the markets: investor behavior.

The study of chart patterns has gone on for at least a century, and analysts have written many excellent books about this topic over the past decades. Today, many traders prefer to focus on technical indicators that are computer driven and are based on complex mathematical formulas. But computer models have yet to prove that they can consistently outperform pattern recognition as an analysis approach.

The following chart patterns are well known, have a high analytic value, and can be combined with other trading tools described in this book.

Selected Reversal Chart Patterns

The most common reversal chart patterns share three characteristics:

1. They form at the end of an uptrend or downtrend.
2. The bigger the chart formation, the bigger is the following reversal.
3. In general, chart formations on tops are shorter and have a bigger volatility than bottom formations.

Double Top and Double Bottom

The most common chart patterns are double top and double bottom formations. Since double tops and double bottoms occur frequently in small price moves, their forecasting value is somewhat limited. The reliability of double top and double bottom formations increases with the selection of bigger underlying swing sizes.



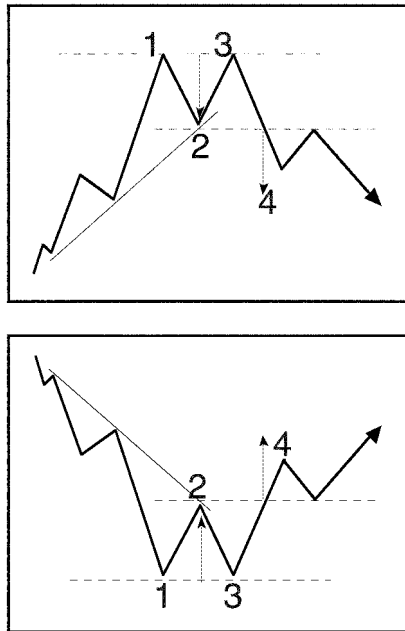

Figure 3.21 Double top and double bottom.

Figure 3.21 illustrates ideal price moves that lead to double top and double bottom formations.

As shown in the price patterns in this figure, the double top formation with peaks at points 1 and 3 is completed only when the valley at point 2 between peaks 1 and 3 is broken on the downside, based on a closing price. As an exception, it can happen that the second peak at point 3 is higher than peak 1. A false breakout is an early indication of a trend change. The maximum swing size can be used as an initial profit target.

Triple Top and Triple Bottom

Triple top and triple bottom chart patterns are based on the notion that three tops or three bottoms can be found almost at the same price level. The forecasting value is the greatest if there is a good symmetry

between the peaks and the valleys. Ideally, the distance is the same from the middle peak (or valley) to the peaks (or valleys) to both the left and right (see Figure 3.22).

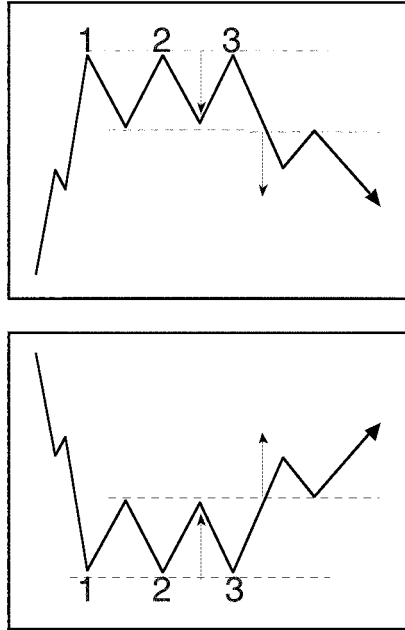

Figure 3.22 Triple top and triple bottom.

A triple top chart formation is completed when the low, which is before the third peak, is broken on a close basis. If the third peak in a triple top formation is a false breakout, this is a strong indication of a trend change. The total distance between the peaks and valleys can be used as the initial profit target.

Head and Shoulder Formation

The head and shoulder formation is the best indication for a trend change. It looks much like the triple top and triple bottom formation.

The only difference is that in a chart formation at the end of an uptrend, peak 3 in the middle is higher than peak 1 on the left side and peak 5 on the right side. Ideally, the right and left shoulder should be on the same height or at least close together. The connection between valley 2 and valley 4 is called the “neckline.”

Figure 3.23 shows a typical head and shoulder formation consisting of three peaks and two valleys with the highest peak in the middle.

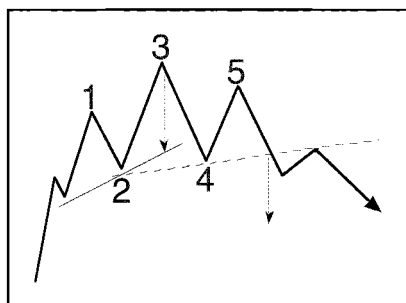

Figure 3.23 Head and shoulder formation.

The head and shoulder formation is completed if the neckline from valley 2 to valley 4 is broken on a close basis. After a breakout, the initial profit target is the distance from the lowest valley to the highest peak of the head and shoulder formation.

Three Falling Peaks or Three Rising Valleys

The formations of the three falling peaks or the three rising valleys are seldom recognized although they have a clear structure and high analytic value (see Figure 3.24).

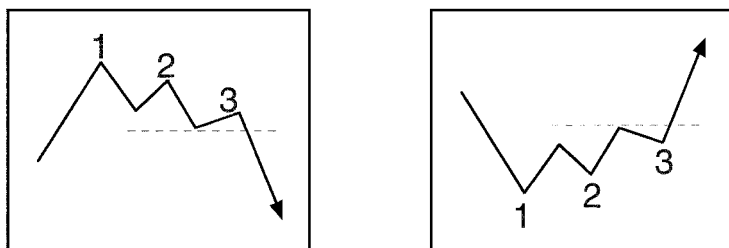

Figure 3.24 Three falling peaks formation and three rising valleys formation.

We get a short signal if the market closes below the second valley, which is located between the second and third peak. We get a buy signal if the market closes above the second peak, which is located between the second and third valley. As the initial profit target after a

short signal, we can take the distance between the highest peak and the lowest valley. This chart formation works equally well for buy and sell signals.

Key-Reversal Day

To identify a key-reversal day, we need fast-moving markets either up or down, based on continuing good or bad news.

After a strong bull market that carries a product into new high territory, there are no more trend or resistance lines, but many investors have huge open profits in their accounts. If there is any bad news, there will be panic selling to protect at least part of the open profits. These price moves can be extreme in products with limit up or limit down facilities (see Figure 3.25).

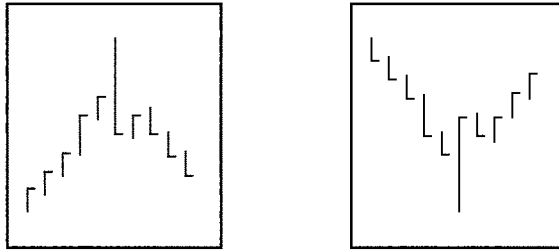

Figure 3.25 Key-reversal day.

The other formations where key-reversal days can be important are false breakouts, especially in combination with triple top and triple bottom formations. If in a triple top formation, the third peak is a false breakout, this will show up many times in a key-reversal day.

Chart patterns can pinpoint major trend changes in the markets. In addition, some price patterns can identify trend moves that are only interrupted for a short sideward interval and then continue in the original trend direction. Price patterns of the latter type are the so-called continuation patterns.

Selected Continuation Patterns

Symmetrical, Ascending, and Descending Triangles

A symmetrical triangle has two merging trend lines. For this formation, at least two peaks and two valleys are necessary. To reduce false

breakouts, investors should wait until there are either three peaks and two valleys or three valleys and two peaks. With this approach, however, it is possible to completely miss a trend.

To receive a valid signal, a closing price has to be above the resistance line or below the support line. The more the price moves to the very end of a triangle, the weaker will be the breakout in either direction.

Figure 3.26 covers the three alternative chart patterns that are based on triangle formations.

In an ascending triangle, the resistance line runs parallel while the support line is rising. To avoid false breakouts, we again recommend waiting for three peaks (or three valleys, respectively). And again, the price to pay for more safety in trading is sometimes missing a trade. We get a signal when the closing price is either above the resistance line or below the support line.

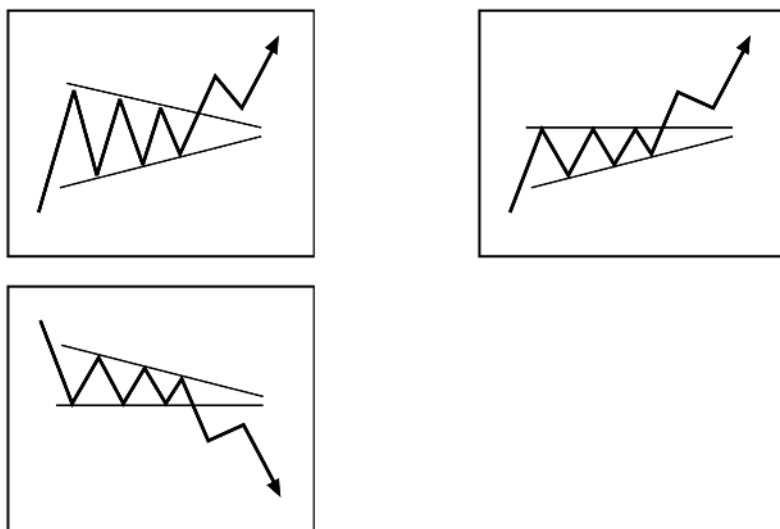

Figure 3.26 Clockwise from upper left: Symmetrical, ascending, and descending triangle.

In a descending triangle, the support line runs parallel while the resistance line falls from the left to the right side. Once more, we recommend waiting for three peaks and valleys even though this might

result in missing a breakout. The initial profit target is the biggest distance measured from high to low of the triangle.

Bullish and Bearish Rectangles

Bullish and bearish rectangles are usually called continuation patterns. However, they can be reversal patterns as well when they turn out to be triple top or triple bottom formations. Support and resistance lines run horizontally. To avoid false breakouts, it pays to wait for three peaks and valleys despite sometimes missing a breakout (see Figure 3.27).

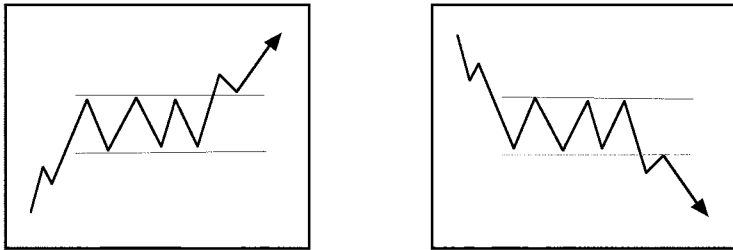

Figure 3.27 Bullish and bearish rectangle.

To receive a trading signal, wait until a closing price is above the resistance or below the support line. The initial profit target is the maximum distance (the total height from high to low) of the bullish or bearish rectangle.

Spring and Upthrust (False Breakout)

A spring is a false breakout from a support line. The market price trades for a very short time below the support line and then moves back above the support line in a volatile price move that opens very low and closes very high.

The upthrust is a false breakout through the resistance line. The market price trades for a brief time above the resistance line and moves back below the resistance line in a volatile move that opens very high and closes very low.

Spring and upthrust are shown in Figure 3.28.

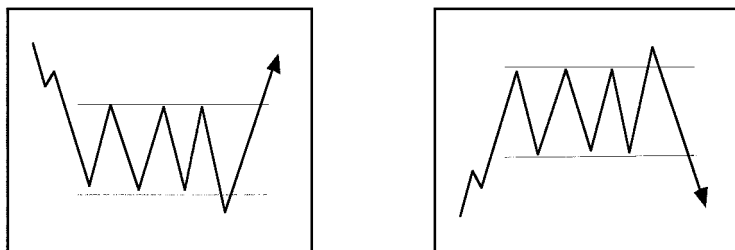

Figure 3.28 Spring and upthrust.

Broadening Formation

The broadening formation is the most difficult chart pattern to trade, for the support and resistance line are moving apart like an expanding triangle.

Figure 3.29 shows price moves to the upside and downside that clarify the picture of consecutive and alternating new highs and lows before a new trend direction finally turns out.

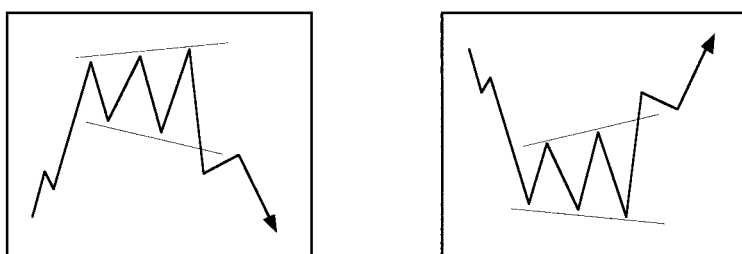

Figure 3.29 Broadening formation.

A trader investing at breakouts will be stopped out at each new high or low. The only way to invest safer is to wait until there are three peaks or valleys. Broadening formations can often be found at long-term tops or bottoms.

Flag and Pennant

Normally, the flag slopes against the main trend and is near midpoint of a price move.

To play safe in a bullish flag, traders should wait for the formation of three valleys. For a buy signal, the closing price has to be above the resistance line. To find the initial profit target, we double the price move from the bottom to the beginning of the flag.

A bullish pennant is almost identical to a symmetrical triangle. The only difference is the time span. Whereas a symmetrical triangle can last a couple of months, the pennant usually does not last longer than three weeks. Because the pennant often happens at the midpoint of a trend, we double the price span from the bottom to the highest point of the pennant for the initial profit target. To receive a valid breakout buy signal in a bullish pennant, we wait until three valleys are formed.

Figure 3.30 shows both chart patterns: the flag and the pennant.

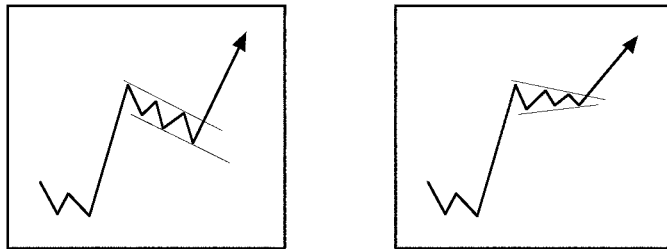

Figure 3.30 Flag and pennant.

Wedge Formation

The wedge formation looks much like the symmetrical triangle. What makes it different is its slant. The wedge formation has a noticeable slant against the prevailing trend. Therefore, a falling wedge is considered bullish, while a rising wedge is considered bearish.

As in all the other formations that we have presented, we should wait for three lower valleys in a bullish wedge. In a bearish wedge, we should wait for three rising peaks.

The wedge breakout occurs most often in the third part of the total length of the wedge. However, the price might go all the way to the very end of the wedge. This is one of the differences from the symmetrical triangle. Wedges take less time to form in downtrends than in uptrends.

Figure 3.31 provides a graphical impression of wedge formations.

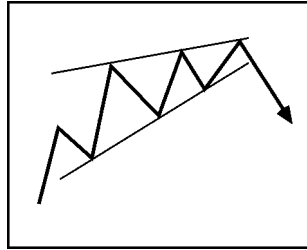

Figure 3.31 Wedge formation.

The initial profit target when working with wedges is measured from the highest high to the lowest low of the wedge formation. This price difference is added to or deducted from the entry price level.

Summary

In this section, we have described the most important chart patterns and have paid special attention to the market price patterns that have at least five price waves (at least three peaks and two valleys or three valleys and two peaks).

The only exception is the key-reversal day, which indicates either an instant trend change at the end of big price move or a trend change after a false breakout.

TREND LINES AND TREND CHANNELS

Human behavior—and investor behavior—is not only reflected in chart patterns such as large swings, small swings, or sideward markets, but to a significant degree in peak and valley formations.

In addition to the patterns described in the preceding section, we have to consider constellations of peaks and valleys that lead to trend lines and trend channels.

By introducing PHI-channels, or Fibonacci trend channels, as independent Fibonacci trading tools, we make use of peak and valley formations in the markets and how to forecast major changes in trend directions.

In this section, we first describe the general structure of regular trend channels. Then we discuss PHI-channels as specific trend channels.

Regular Trend Lines and Trend Channels

Every peak or valley in the markets is a prominent indicator of what the majority of investors were thinking at any particular moment in time. The significance of peaks or valleys becomes evident only through the passing of time. Intraday peaks or valleys are less meaningful than peaks or valleys monitored on a daily basis. In this section, we concentrate on daily data compression.

To draw a trend channel, we need at least three points—two peaks and a valley or two valleys and a peak. Figure 3.32 shows a regular 3-wave price pattern.

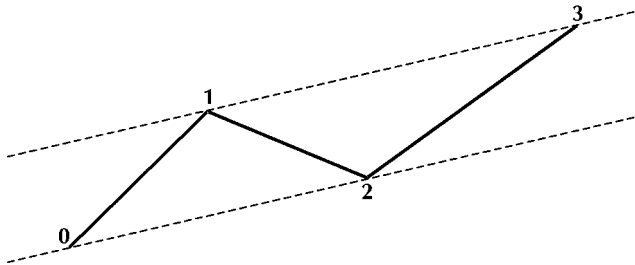

Figure 3.32 Regular trend channel.

To draw a trend line between point 0 and point 2, peak 1 must be penetrated to confirm the uptrend. Once it is possible to draw the trend line between point 0 and point 2, investors can project peak 3 by drawing, through point 1, the parallel to the support line connecting point 0 and point 2. Different trend lines are used to stay as close as possible to the different degrees of a trend. When the upper channel line is broken, a new trend channel can be drawn if the market's price keeps moving higher (Figure 3.33).

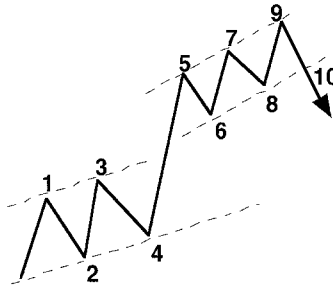

Figure 3.33 Continuing trend channels.

A failure to reach the resistance line of the channel in an up-trend is often an early warning signal that the support line will be broken on a trend reversal at point 10 (vice versa for a downtrend).

PHI-Channels

PHI-channels vary in distinct ways from regular trend channels. Initially, we can detect the same pattern structure as regular trend channels. However, instead of isolating the outside points, connecting highs with highs and lows with lows to come up with trend lines, we base PHI-channels on peak-to-valley and valley-to-peak connections.

The baseline of a PHI-channel can be generated out of a 3-wave market move, as shown in Figure 3.34.

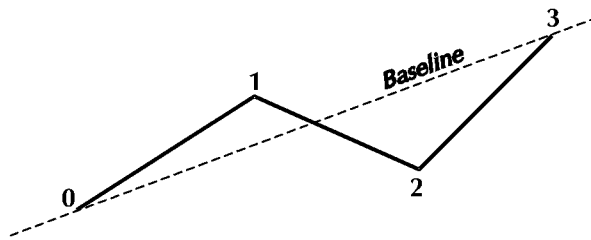

Figure 3.34 Baseline of a PHI-channel.

The baseline of a PHI-channel is the connection of the price move from the bottom, at point 0, to the top, at point 3. By connecting the high point 3 with the low point 0, we eliminate the biggest problem in working with regular outside trend channels: staying close enough to fast changes in price patterns.

After establishing the baseline, we draw a parallel line to the baseline, using low point 2 as our outside point to the right of the price pattern. The distance from the baseline to the parallel line is the width of the PHI-channel, which can be used to calculate further parallels to the right based on the Fibonacci ratios.

The important charting technique of getting to a set of parallel trend lines in Fibonacci distances from the PHI-channel is illustrated in Figure 3.35.

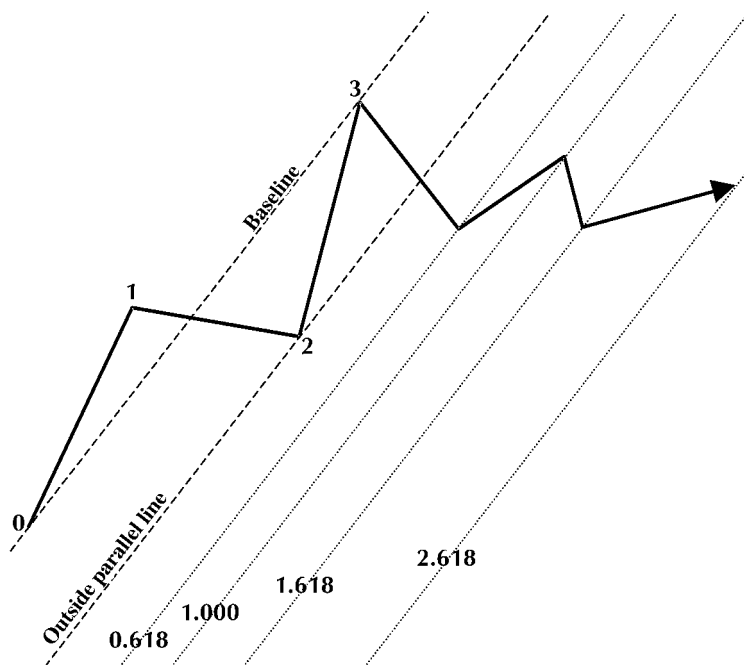

Figure 3.35 Baseline and outside parallel line of a PHI-channel, and resulting trend lines in Fibonacci distances.

The regular trend channels generally are used as indicators of trend market moves, not as trading tools to generate buy and sell signals. PHI-channels are a good Fibonacci-related instrument to generate buy and sell signals, especially when used in combination with other trading tools, as described later in this book.

Summary

Regular trend channels and PHI-channels are important tools for every analyst. They represent investor behavior and often indicate the support and resistance areas in the market.

In contrast to regular trend lines and trend channels, which are mostly used for trend indications, PHI-channels can be used to generate buy and sell signals. Breakouts of PHI-channels lead to buy and sell signals at the outside lines of the respective PHI-channels. We describe PHI-channels in greater detail in our previous book, *The New Fibonacci Trader*.

4

APPLICATIONS OF TRADING STRATEGIES

In this chapter, we first briefly describe the relevant investment principles for merging candlestick charting into Fibonacci analysis. We then explain how to apply these trading strategies to market data.

The discussion includes double top and double bottom formations, Fibonacci corrections and extensions, applications of candlestick patterns and important price patterns in bar charting, and finally, the advantages of using PHI-channels.

DOUBLE TOPS AND DOUBLE BOTTOMS

Double top and double bottom formations are the most common reversal patterns. If double top formations occur after an uptrend, they are called “M” formations; after a downtrend, double bottom formations are called “W” formations.

Although most traders are familiar with these two chart patterns, it is helpful to study them because the basics covered here are applicable to more complex strategies later on. For example, tops and bottoms are very important when working with Fibonacci price corrections.



Basics for Working with Double Tops and Double Bottoms

Double tops and double bottoms can happen in any price swing, big or small, weekly, daily, or intraday. In very small swing sizes, they may look attractive for trading. After deducting commissions and slippage, however, little profit remains in long-lasting sideways patterns. Bigger swing sizes are preferable to work with, but they have fewer trades. The ideal M formation has both peaks at almost the same level. With W formations, the same should be true for both valleys.

Having the same level is not critical for success. Although the second high is slightly higher than the first high, a sell signal can be profitable if the expected swing size is reached. A double top pattern is only complete if the valley between the two peaks is broken by a daily close (when working with daily data).

A double top is difficult to identify if the second top is higher than the first top. It always makes traders question whether to expect a higher price or a “bull trap.” The following compromises may be helpful in dealing with this problem:

- When working work with daily data, the daily close has to be higher than the first peak.
- The market price must go 3 percent higher than the first peak.
- Two daily highs have to be higher than the first peak.

These are not optimal filters, for waiting can mean getting in very late and missing a profit opportunity. But false breakouts are costly as well and can cause big losses in an account. When the closing price is lower than the first peak in a double top formation, a false breakout can indicate a price change.

Swing Size

The most important determiner of success with double top or double bottom formations is the swing size that the trader chooses for analysis.

The application of swing sizes that are too small will generate excessive commissions and slippage.



Increasing the swing size will dramatically reduce the number of trades. Although this might not be attractive for traders who want to see action, it improves the chances for profitable trades while limiting commissions and slippage. As a rule of thumb, there should not be more than 5 to 10 trades a year in a product like the S&P 500 Futures Index.

Figure 4.1 shows daily data for the DJ EuroStoxx 50 Futures Index between August 2001 and August 2002. The 13 turning points marked on the chart are based on a swing size of 300 points.

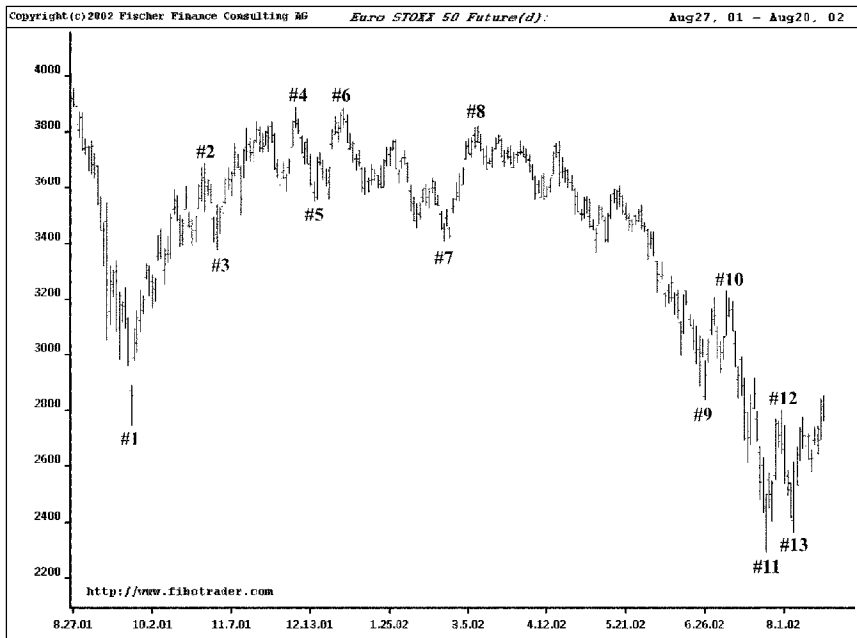

Figure 4.1 DJ EuroStoxx 50 chart from 8–01 to 8–02. Significant turning points.

The appropriate swing size is closely related to the volatility of a product and has to be determined for each product separately. Computer simulations can do this easily on historical test data. The time span for the test results should be at least 3 to 5 years.

We consider the application of double top formations and double bottom formations to be a valid investment strategy. Its use demands discipline, however, since the investor must closely follow stop-loss rules, profit targets, or entry rules.

Entry Rule

Traders get a long or short signal if the swing size is broken by the daily close (on daily data). There are many ways in practical trading to modify this approach, but the concept remains unchanged throughout our analysis.

As we demonstrate on computer test runs later on, this approach is profitable over time.

Figure 4.2 shows the entry rule for buying and selling.

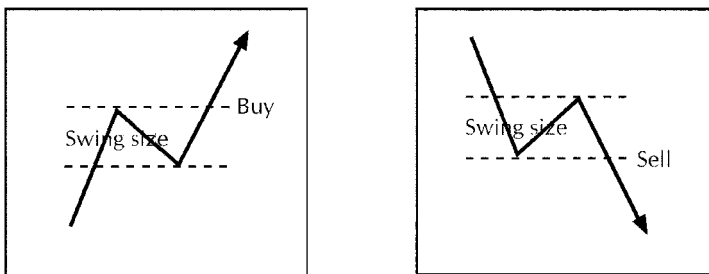

Figure 4.2 Entry rule.

In addition to entry rules that can help traders track changing markets, reliable stop-loss exit rules can help them control risk in their positions.

Stop-Loss Rule

The investor gets stopped out of a position if, after the entry, a previous peak or a previous valley is broken based on a closing price.

There are many ways to place stop-loss orders. The conservative approach presented here reduces whipsawing. In a strong market, however, the loss may be bigger than expected, because positions are only closed out based on the daily closing price level. The

experienced trader might work with two stop rules, depending on the market situation.

Figure 4.3 shows the stop-loss rule after a long and a short entry.

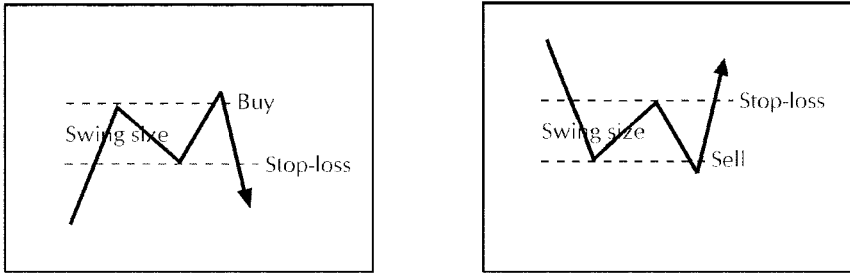

Figure 4.3 Stop-loss rule.

Profit target exit rules to protect positions with accumulated profits complement stop-loss rules used to protect positions against excessive losses.

Profit Target Rule

At this point in the discussion, we use the total swing size as the profit target (e.g., if the swing size is 300 points, our profit target is 300 points).

It is amazing how often this simple rule works. But sometimes it does not. The experienced trader might want to tailor other rules for a special product or market situation. The preceding profit target rule is shown in Figure 4.4.

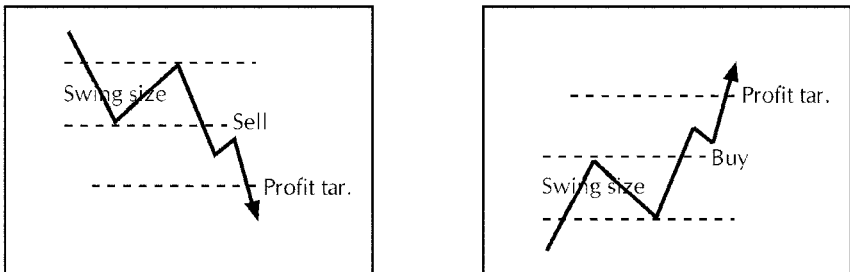

Figure 4.4 Profit target rule.

The rules described here work if traders have the patience to wait for profit targets and can live with bigger stop-loss rules. There is no perfect rule: every market situation is unique and products differ in volatility.

We have backtested these rules in a diversified portfolio; they work. Later, we discuss these rules in greater detail. To keep it simple, we did not describe trailing stops, but they are included in some of the examples.

Example

In Figure 4.5, we show how to apply the strategy of double tops and double bottoms using the DJ EuroStoxx 50 Futures Index between August 2001 and August 2002. Because we are working with a big swing size, there are only three signals in the test period. It is easy to increase the number of trades by reducing the swing size to 200 points or 100 points.

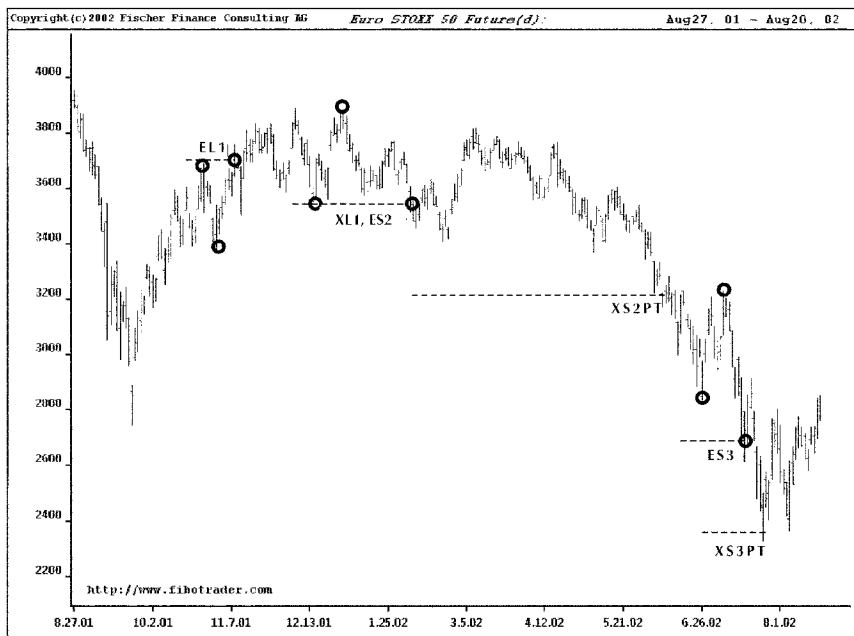

Figure 4.5 DJ EuroStoxx 50 chart from 08–01 to 08–02. Trading signals (EL: entry long, ES: entry short, XL: exit long, XS: exit short, PT: profit target).



Figure 4.5 consists of three entry signals and profit targets. We did not get stopped out. The strategy might look unimpressive, but in the same time frame hardly any fund managed to get a positive performance.

To further clarify the strategy underlying double tops and double bottoms, Table 4.1 shows a breakdown of the different signals.

Table 4.1 Trading Signals

#	Entry Rule	At	Exit Rule	At	Profit/ Loss in Points
1	Buy long	3,727.00	Sell reverse	3,550.00	(177.00)
2	Sell reverse	3,500.00	Buy flat	3,250.00	300.00
3	Sell short	2,700.00	Buy flat	2,400.00	300.00

These strategies work best in products with high volatility. They can be easily applied with little work. Diversification is important to reduce the portfolio risk.

Summary

The strategies of double tops and double bottoms have the following characteristics:

- They work on every product and are easy to follow and execute.
- The number of trading signals depends on the swing size (the smaller the swing size, the higher the number of trades including transaction costs such as commission and slippage).
- There are many losing trades with small swing size.
- The profit/loss ratio is much better with bigger swing sizes.
- Products with large swings and high volatility are highly profitable.



FIBONACCI PRICE CORRECTIONS

The strategy of trading corrections can be very successful if it is related to the figures of the Fibonacci summation series and the Fibonacci ratios.

The analysis would be simple if there were a general chart pattern for price corrections. The problem is that products always have more corrections than impulse waves. This means that products always move in a sideways pattern for a longer time than they move in impulse waves. In general, markets move sideways about 70 percent of the time and in impulse waves in the remaining 30 percent.

It is never possible to know in advance whether a new breakout will be the beginning of an uptrend or a downtrend, or a false breakout with a continued sideways pattern. Therefore, traders must adjust their strategies so that they can survive the longest sideways patterns. No market pattern can guarantee profits because no one knows in advance the pattern that the market will take at any given time.

When working with corrections as an investment strategy, it is necessary to integrate stop-loss rules, profit target rules, and entry rules. This strategy will only make profits over time if the stop-loss is smaller than the profit target and there are more profitable transactions than losing trades.

A strategy based on price corrections can be computer-programmed and tested on historical data. Some simulations that we have made can be found at the end of this chapter.

Basic Features of Trading Price Corrections

Working with corrections is a trend-following strategy based on the assumption that after a correction of an impulse wave up or down, the next impulse wave will follow the direction of the first wave.

Working with corrections is a short-term strategy. The goal is to have a high number of profitable trades and only a few losing trades (at small individual losses per losing trade).

Traders always must be aware of the possibility of false breakouts. False breakouts on the downside are often called “bear traps,” and on the upside they are called “bull traps.” Intraday data frequently reveal these patterns. In Figure 4.6, we present ideal-typical



market moves of false breakouts for bull trap and bear trap chart patterns.

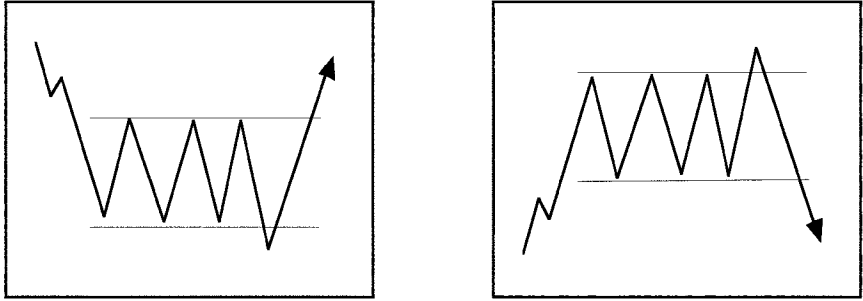

Figure 4.6 False breakouts to the downside and to the upside.

Traders can base trading signals on false breakouts if they know how to separate the different types of breakouts. We discuss this topic in more detail later on when we talk about entry rules.

Size of Corrections

The most common approach for working with corrections in research and practical trading is to relate the size of the corrections to a percentage of the prior impulse move.

In our analysis, we concentrate on 61.8 percent, which is directly related to a ratio out of the Fibonacci summation series. A price correction of 61.8 percent is the result of division ($1.000 \div 1.618$).

Forecasting the exact size of a correction is an empirical problem. Investing after a correction of just 38.2 percent might be too early, whereas waiting for a correction of 61.8 percent might mean missing a strong trend completely. We concentrate on 61.8 percent and keep the investment risk very small by placing a well-defined close stop-loss.

The best way to work with corrections is to combine the percentage of corrections with the swing size as a second parameter. Each product has a typical swing pattern that traders can identify with a computer simulation. This pattern should be part of the investment strategy. To get the best real-time results, the investor needs to identify and test it on historical data.

The swing size depends on the product. The swing sizes between daily data and intraday data on the same product can be very different. The smaller the swing sizes are, the more noise there is in the price data and the more difficult it will be to filter out the product's typical swing size.

For example, if 150 basis points cover the swing size in the cash currency Japanese Yen every day, correction levels of 38.2 percent, 50.0 percent, or 61.8 percent might be too small to work with. On the other hand, a correction level of 38.2 percent might be the best to work with if, in the same product, we measure a price swing of 1,000 points over a longer period. It might take weeks before the market price has a correction of 382 basis points.

Entry Rules

The main reason to work with an entry rule is to get an additional confirmation of trend changes. Working with entry rules also means working with a compromise because we always invest a little later than if we had entered the market as soon as a correction price target was reached. By giving up a little bit of the profit potential, we gain a safety net to avoid getting stopped out and whipsawed so often.

Because we work only with a 61.8 percent correction level in our strategy, we need just one entry rule. We buy or sell—after the correction level of 61.8 percent has been reached—when the previous day's high or low is broken.

Figure 4.7 shows market entries to the long and short side.

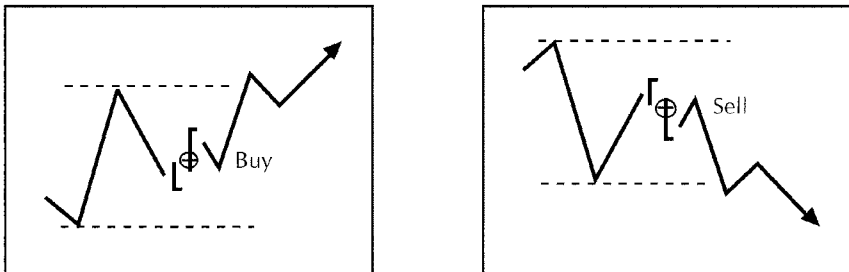

Figure 4.7 Entry signals long and short after price corrections of 61.8 percent on 1-day high and low breakouts.

As mentioned, we always have to expect false breakouts. We can integrate this into our investment strategy with a more conservative entry rule. We buy and sell after a false breakout as soon as the previous 2-day high or the previous 2-day low is broken (see Figure 4.8).

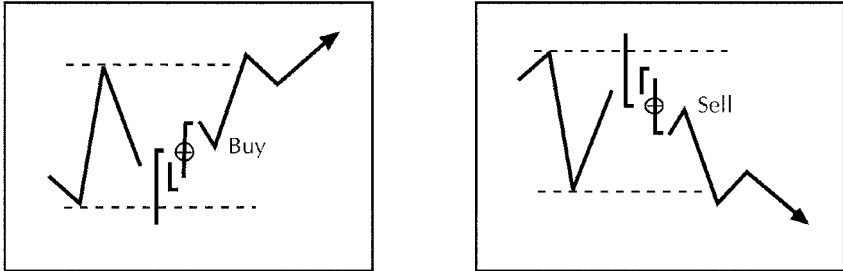

Figure 4.8 Entry signals long and short after false breakouts on 2-day high and low breakouts.

Immediately after establishing market positions, traders need to protect them with stop-loss rules.

Stop-Loss Rule

In working with price corrections, the stop-loss after the entry should be the peak (on short signals) or valley (on long signals) before the entry point.

Figure 4.9 shows the stop-loss rule of a peak/valley exit and the imminent stop-loss risks.

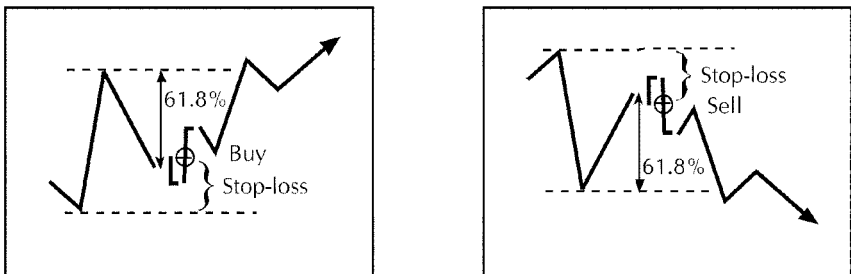

Figure 4.9 Exits on valleys (long) and peaks (short) and imminent stop-loss risks.

The size of the stop-loss changes in relation to the chosen correction level and the swing size. For example, if the swing size is 300 basis points, the correction level is 61.8 percent, and the stop-loss is below the previous valley, our risk is much smaller than if we enter the market already at 38.2 percent or 50.0 percent correction level and define the same stop-loss point. On the other hand, we can miss a complete price move if the market price does not reach our correction level.

Working with the 61.8 percent correction level is preferable because we can have a small stop-loss and, therefore, less risk. The stop-loss level is after a buy signal below the previous valley and after a sell signal above the previous peak. After a false breakout, the highest high or the lowest low before the false breakout is the stop-loss level.

Trailing Stop Rule

To protect profits, traders can work with a trailing stop as an alternative to profit targets.

A trailing stop is not always the best investment strategy. After investors get stopped out with a small trailing stop, the market price may continue the original trend direction and they will miss the big price move. Depending on the product and volatility, we recommend working with a 3- to 4-day trailing stop.

Figure 4.10 covers the exit rule of a 4-day trailing stop.

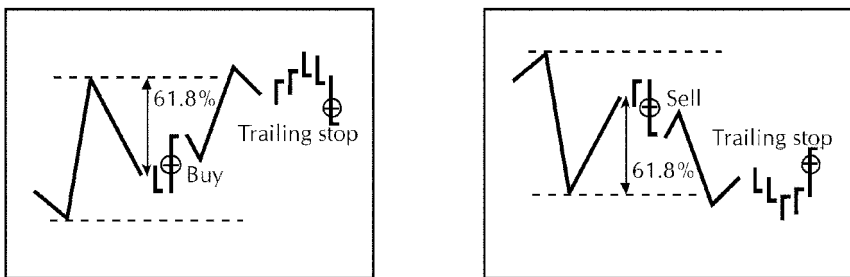

Figure 4.10 Long and short positions protected with trailing stop exits on 4-day low and high breakouts.

The more conservative option is to work with the previous peak or valley in profitable territory as a trailing stop.

Practical Applications of Price Corrections

Working with corrections requires accuracy and discipline. The chances for profits are very high in products with a big swing size and volatility such as in the S&P 500 Index, the Nasdaq 100 Index, the Dax 30 Index, and the DJ EuroStoxx 50 Index. Cash currencies such as the U.S. Dollar against the Japanese Yen or the Euro against the U.S. Dollar also may present opportunities.

But a big swing size in a product we want to trade is not enough. High volume is at least as important. If the volume in the product is too small, the slippage and commission may make trading unprofitable.

Before working with corrections, traders need to determine the swing size and correction level that they want to work with. Only then can we determine whether a product has naturally big or small swings and has a high or low volatility.

There is no perfect rule to determine these parameters, because every product is different. But eyeballing daily historical data for about a 3-year period can provide a good indication. As a rule of thumb, a product should not have more than 15 to 20 peaks or valleys over a 12-month period.

In the DJ EuroStoxx 50 Index shown in Figure 4.11, a swing size of 300 basis points is a good size to work with. In the S&P 500 Index, a swing size of at least 80 ticks is needed (a move from 1,000.00 to 1,080.00). In the Japanese Yen cash currency, a swing size of 180 ticks (a move from 110.00 to 111.80) is appropriate.

Determining whether we are in an uptrend or a downtrend also can be a problem while working with corrections. The status of the market has to be addressed first; otherwise, investors will never be able to decide in what direction to invest.

As long as the market price continues to make new lows and the swing size is bigger than our predetermined swing size based on historical test runs, we will always sell if the correction level reaches 61.8 percent. If the market makes new highs, we receive buy signals whenever a trend correction of 61.8 percent occurs. But we will never know in advance whether we invest:

- Into a correction of an impulse wave in a downtrend.
- Into an impulse wave in an uptrend.



Only future price movements can answer this question. To deal with this problem, we recommend working with bigger swing sizes and correction levels. Although we may anticipate the direction of the next impulse wave incorrectly, our risk remains low and we can liquidate a position with a small loss if we are on the wrong side of the trend direction (see Figure 4.11).

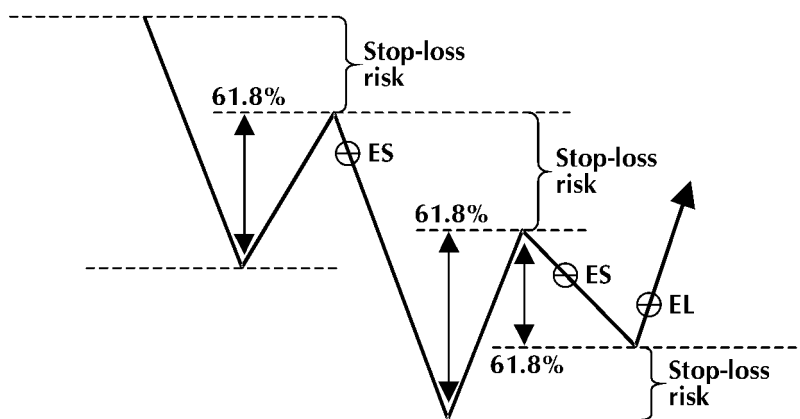

Figure 4.11 Risk levels if a correction is already the impulse wave of a new trend.

Table 4.2 sums up parameters for percentage of retracement, swing size, and entry rule.

Table 4.2 Swing Size, Correction, and Entry Rule

Swing Size in Ticks	Correction in %	Entry Rule Previous High-Low in Days
100–200	61.8	3–4
200–400	38.2	3–4
200–400	50.0	2
200–400	61.8	1
400–800	38.2	3
400–800	50.0	1
400–800	61.8	1

Source: *The New Fibonacci Trader*, by Robert Fischer (New York: Wiley, 2001), p. 59.

Every time investors choose to enter a market according to a pattern of corrections to initial impulse wave, they must make sure that the entry is realized by the time of the correction (or at least close enough to the time of the correction). A reliable way to manage being on time (or at least close enough for the correction) is to combine swing size and correction level with a convincing entry rule.

Generally speaking, a strong first impulse wave is followed by a strong correction. The second impulse wave should be bigger than the first impulse wave. Therefore, a more sensitive entry rule can be used.

Different entry rules in relation to swing sizes are shown in Figure 4.12.

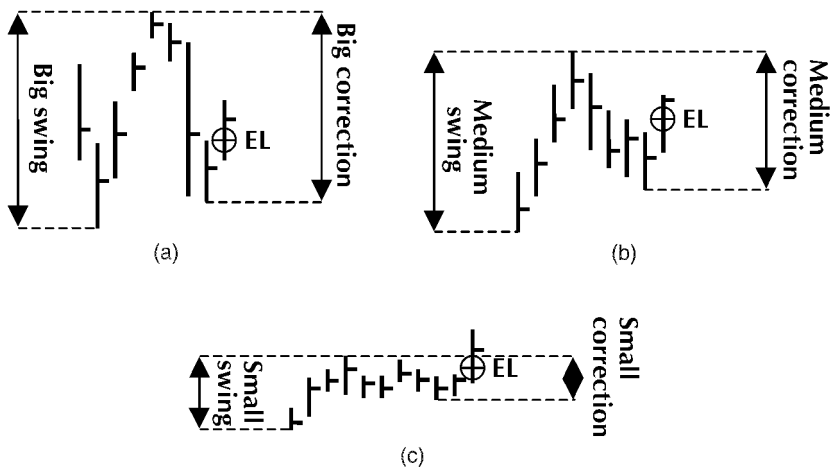

Figure 4.12 Big swing, big correction, previous 1-day high entry; medium swing, medium correction, 2-day high entry; small swing, small correction, previous 3-day high entry rule. Source: *The New Fibonacci Trader*, by Robert Fischer (New York: Wiley, 2001), p. 60.

Many successful combinations of swing size, retracements, and entry rules are possible. The sample constellations in Table 4.2 show the underlying general pattern and how the three parameters go together in a productive way. There are many other workable combinations.

Sample parameters for an investment in the S&P 500 Index might look like this:

- The minimum initial swing size in the S&P 500 Index is set to 80 basis points (a sample move from 1,000.00 to 1,080.00). If no correction is as big as 61.8 percent, we do not get a signal.
- We never try to catch up with a runaway market, no matter how strongly the S&P 500 Index might start to move, unless we get another entry chance that adheres to the rules of price corrections.
- When a correction reaches the level of 61.8 percent, we have to enter long on the buy side at the previous day's high, or short on the sell side at the low of the previous day.
- After we are invested, we work with a profit target of 0.618 times the total swing size of the first impulse wave. We work with a trailing stop that is set at the lowest low of the previous four days. Our stop-loss level is defined at the low of the starting day of the initial impulse wave.
- We do not follow a reentry rule. If we get stopped out, we wait for a full new swing high or low based on the minimum swing size; only then do we start looking for new trading opportunities.

Trading Signals

All of the buy and sell signals that are presented in this section are based on calculations from daily bar charts. At the end of this chapter, we provide readers with years of computer test runs on various products. We use three examples—the S&P 500 Index, the DJ Euro-Stoxx 50 Index, and the Japanese Yen in the cash currency market—to explain valid strategies for making money through price corrections. We remind readers, however, that these illustrations are purely for educational purposes and are not recommendations for specific trades.

The book's CD-ROM enables every investor to generate the same results that are shown here because the sample data sets we used are included with the software.

Based on the preceding set of parameters for swing size from highs to lows and lows to highs, retracement, entry rule, profit



target, trailing stop, and stop-loss rule, nine sample trading signals can be generated for the S&P 500 Index from January to November 2000.

Figure 4.13 shows the relevant entry and exit points for the trading simulation in the S&P 500 Index. It consists of nine entry signals, profit targets, and trailing stops. A stop-loss exit applies only once on the very first trade. The strategy looks quite impressive; the year 2000 was favorable for trading corrections.

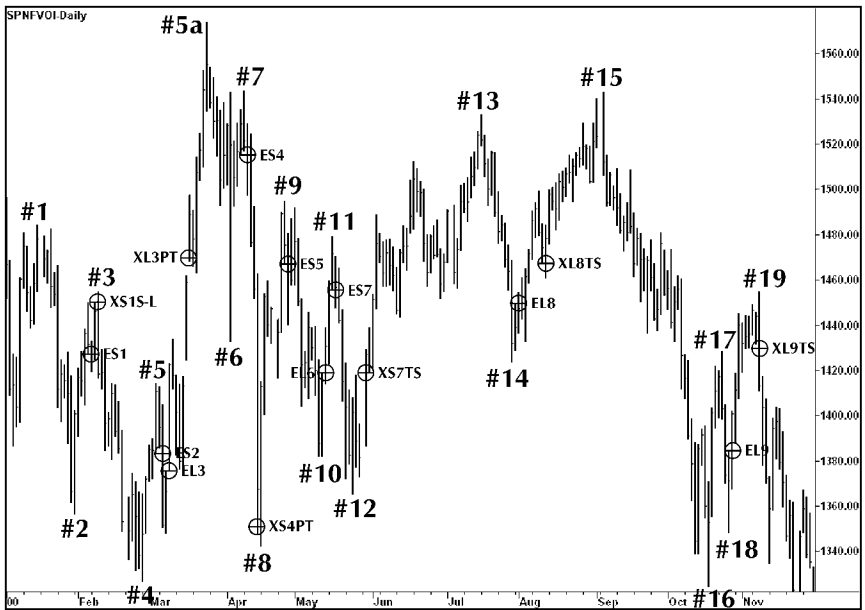

Figure 4.13 S&P 500 chart from 01-00 to 11-00. Simulation of trading signals based on corrections daily (EL: entry long, ES: entry short, XL: exit long, SX: exit short, S-L: stop-loss, PT: profit target, TS: trailing stop).

Table 4.3 shows the breakdown of the different signals for a strategy that relies on corrections. The table consists of the nine trading signals in the S&P 500 Index with the respective high and

low references from the chart, entry rules, exit rules, and profit or loss per position.

Table 4.3 Trading Signals

High#/ Low# Reference	Entry Rule	At	Exit Rule	At	Profit/ Loss in Points
H#1/L#2	Entry sell	1,427.50	Stop-loss	1,449.80	(22.30)
H#3/L#4	Entry sell	1,386.20	Reverse buy	1,385.50	0.70
L#4/H#5	Reverse buy	1,385.50	Profit target	1,468.50	83.00
H#5a/L#6	Entry sell	1,517.50	Profit target	1,351.30	166.20
H#7/L#8	Entry sell	1,467.00	Reverse buy	1,419.00	48.00
L#8/H#9	Reverse buy	1,419.00	Reverse sell	1,456.00	37.00
H#9/L#10	Reverse sell	1,456.00	Trailing stop	1,418.00	38.00
L#12/H#13	Entry buy	1,449.00	Trailing stop	1,468.00	19.00
L#16/H#17	Entry buy	1,384.20	Trailing stop	1,430.00	45.80

To illustrate the application of price corrections with a second data sample, we conducted a similar simulation of trading signals on the Japanese Yen cash currency. The basic underlying parameters for this analysis are:

- Minimum swing size of 1.80 JPY (a sample move from 110.00 to 111.80).
- Retracement of at least 61.8 percent.
- Entry rule at previous 1-day high or low, no reentry.
- Profit target at 0.618 times the size of the impulse swing; trailing stop set to 4-day low on buys and 4-day highs on sells.

The application of these parameters to the daily bar chart of the Japanese Yen cash currency results in a set of sample signals comparable to the ones in the S&P 500 Index. By similarly analyzing the Japanese Yen cash currency, we can prove that the strong gains in the S&P 500 Index were not accidental (Figure 4.14).



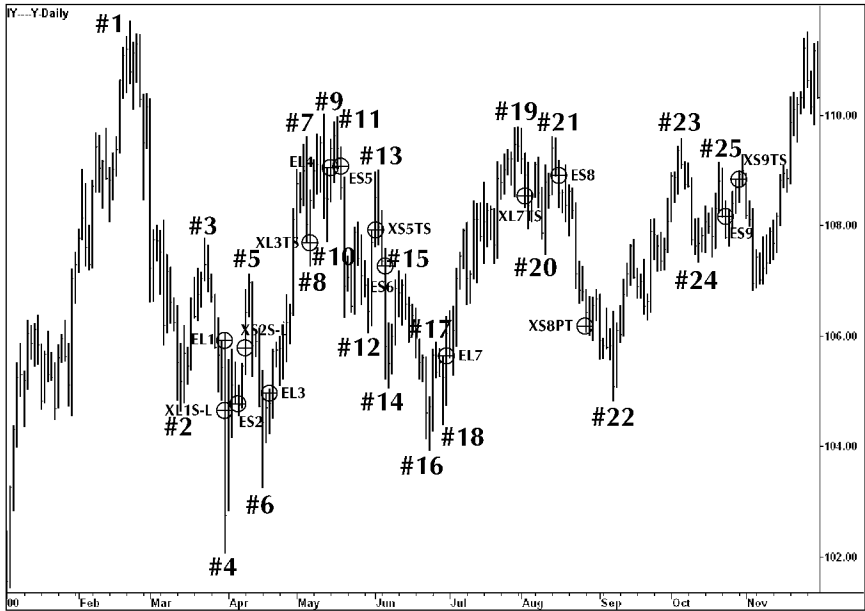

Figure 4.14 Japanese Yen chart from 01–00 to 11–00. Simulation of trading signals based on corrections daily (EL: entry long, ES: entry short, XL: exit long, SX: exit short, S-L: stop-loss, PT: profit target, TS: trailing stop).

The nine sample trades in the Japanese Yen cash currency have been profitable overall. Six trades ended up in wins, and only three trades were losing trades. Profits totaled almost 9.00 points, which is a promising result for 11 months of sample calculations.

To interpret the results properly when trading the Japanese Yen against the U.S. Dollar, readers must keep in mind that falling prices indicate a stronger Japanese Yen and rising prices indicate a stronger U.S. Dollar. Buy signals in our calculation, therefore, refer to a speculation on rising prices, which means a stronger U.S. Dollar and a weaker Japanese Yen. Sell signals refer to an opposite speculation on a stronger Japanese Yen and a weaker U.S. Dollar. Thus, we buy and sell U.S. Dollars with reference to the Japanese Yen as the base value for our calculation of profits or losses.

The peak-valley references, as well as the profits and losses for the signals in the Japanese Yen cash currency against the U.S. Dollar, are summarized trade by trade in Table 4.4.

Table 4.4 Trading Signals

High#/ Low# Reference	Entry Rule	At	Exit Rule	At	Profit/ Loss in Points
L#2/H#3	Entry buy	105.90	Stop-loss	104.65	(1.25)
H#3/L#4	Entry sell	104.79	Stop-loss	105.76	(0.97)
L#4/H#5	Entry buy	104.94	Trailing stop	107.71	2.77
L#8/H#9	Entry buy	109.04	Reverse sell	109.05	0.01
H#9/L#10	Reverse sell	109.05	Trailing stop	107.91	1.14
H#11/L#12	Entry sell	107.67	Reverse buy	105.63	2.04
L#16/H#17	Reverse buy	105.63	Trailing stop	108.55	2.92
H#19/L#20	Entry sell	108.91	Profit target	106.15	2.76
H#23/L#24	Entry sell	108.25	Trailing stop	108.82	(0.57)

The results in the S&P 500 Index and the Japanese Yen cash currency are very promising. However, it is a serious mistake to overestimate the strong gains accumulated with the profitable strategy of combining corrections with parameters for swing size, entry rule, stop-loss rule, and profit target. During this sample's limited time span of 11 months, market conditions happened to favor the strategy of investing into corrective waves in the index futures and cash currency markets.

Extended Example

The problem with every test run is the time period tested. To show a product of the most recent 12 months, we have selected the DJ EuroStoxx 50 Index from August 2001 to August 2002.

The one-year period from mid-2001 to mid-2002 is interesting because it includes uptrends, downtrends, and sideways market patterns. The more we trace upmoves and downmoves mixed with sideways periods, the more reliable our trading strategy will become if the results of a simulation prove profitable.



The following parameters are used for the DJ EuroStoxx 50 Index simulation:

- Our correction level is 61.8 percent, the minimum swing size is 300 basis points (a sample move from 2,600.00 to 2,900.00).
- As an entry rule, we choose the previous 1-day high or low. In case of false breakouts, we work with 2-day highs or 2-day lows.
- As a trailing stop, we work with a 3-day penetration. After a buy signal, the stop-loss is below the low of the previous impulse wave based on a daily close (vice versa for a sell signal).

Figure 4.15 shows a chart with 15 trading signals. To make it easier to follow the chart, the same signals are summarized trade by trade in Table 4.5.

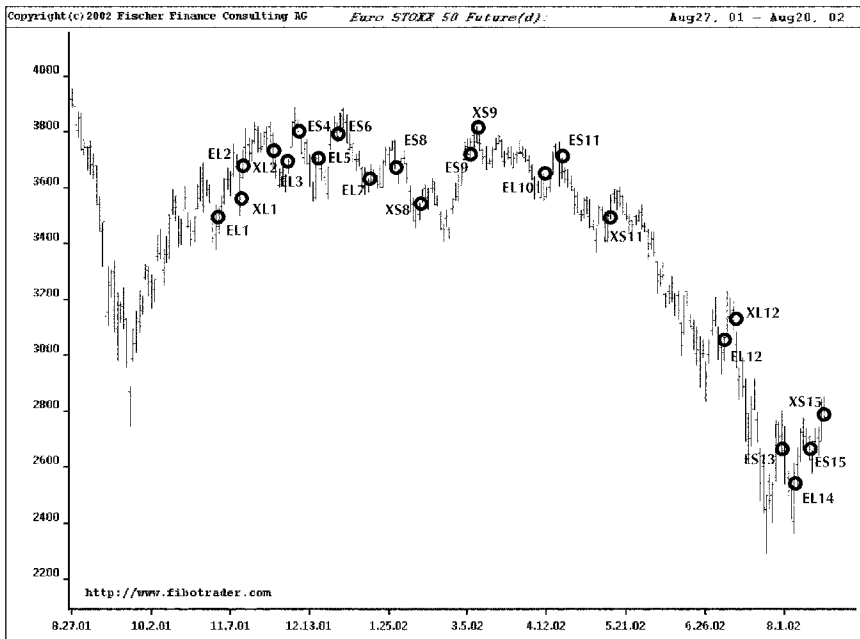

Figure 4.15 DJ EuroStoxx 50 chart from 08–01 to 08–02. Simulation of trading signals based on corrections daily (EL: entry long, ES: entry short, XL: exit long, SX: exit short; trading signals numbered consecutively from 1 to 15).

Table 4.5 Trading Signals

#	Entry Rule	At	Exit Rule	At	Profit/ Loss in Points
1	Buy long	3,495.00	Sell flat	3,574.00	79.00
2	Buy long	3,678.00	Sell flat	3,729.00	51.00
3	Buy long	3,671.00	Sell reverse	3,819.00	148.00
4	Sell reverse	3,819.00	Buy reverse	3,624.00	195.00
5	Buy reverse	3,624.00	Sell reverse	3,797.00	173.00
6	Sell reverse	3,797.00	Buy reverse	3,649.00	148.00
7	Buy reverse	3,649.00	Sell reverse	3,736.00	87.00
8	Sell reverse	3,736.00	Buy flat	3,567.00	169.00
9	Sell short	3,725.00	Stop-loss	3,801.00	(76.00)
10	Buy long	3,628.00	Sell reverse	3,707.00	79.00
11	Sell reverse	3,707.00	Buy flat	3,534.00	173.00
12	Buy long	3,052.00	Sell flat	3,073.00	21.00
13	Sell short	2,670.00	Buy reverse	2,540.00	130.00
14	Buy reverse	2,540.00	Sell reverse	2,663.00	123.00
15	Sell reverse	2,663.00	Stop-loss	2,800.00	(117.00)

Summary

Price corrections are important and profitable Fibonacci-related trading tools as long as investors handle them properly.

The following considerations are essential when working with price corrections:

- Consistency in the strategy.
- Different swing sizes and volatilities for different products.
- Magnitude of the first impulse wave from which the correction level is measured.
- Strength of the market trend.
- Data compression (weekly, daily, or intraday data).



Even more important is that corrections can be computer-programmed and tested on historical price data. This makes it easier for traders to analyze different products at the same time to achieve better diversification.

To conclude this section, we present some test results on a variety of stocks, one stock index future, and one cash currency (see Table 4.6).

Table 4.6 Selected Computer Test Results

Product	Period	Profit/ Loss in EUR	#	Wins %	Max DD in EUR
766400 Volkswagen	1996+	13,438.00	14	50	(9,373.00)
870737 Nokia	1996+	20,850.00	11	54	(7,243.00)
940602 Philips	1996+	20,993.00	9	56	(5,165.00)
840400 Allianz	1996+	15,302.00	8	38	(3,956.00)
723610 Siemens	1996+	15,077.00	12	33	(8,206.00)
Dax 30 Futures Index	1996+	31,532.00	36	44	(17,437.00)
USD/JPY	1996+	26,250.00	6	66	(21,430.00)

FIBONACCI PRICE EXTENSIONS

Price extensions are volatile price movements that result from runaway markets. Usually, price extensions occur when unexpected news reverses the trend direction.

This discussion of price extensions is subdivided into two parts: price extensions in 3-wave patterns, and price extensions in 5-wave patterns.

Price Extensions in 3-Wave Patterns

Extensions take place primarily in the third wave of a 3-wave price pattern. In an uptrend, the correction does not go lower than the bottom of wave 1, whereas in extensions out of a bull trap or bear trap formation of irregular tops or bottoms, the correction can go higher than the high of the first impulse wave or lower than the low of the first impulse wave, respectively.



Two basic chart formations for price extensions are illustrated in Figure 4.16.

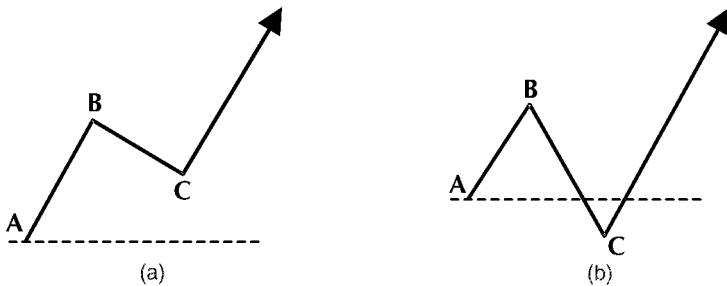

Figure 4.16 Extensions out of a regular 3-wave pattern and a bear trap chart formation.

Exploring extensions means investing against major trend directions. Investors looking for quick profits by taking advantage of imbalances in the marketplace need to know not only when to enter a position in advance, but also when to exit it.

Calculating price targets in extensions of the third wave out of a 3-wave chart formation requires the following steps:

- Defining a minimum swing size and setting it to the size from peak to valley (or valley to peak) of the first impulse wave of the 3-wave pattern.
- Multiplying the swing size by the Fibonacci ratio 1.618.
- Adding the resulting value to the size of the initiating swing to define the price target.

Figure 4.17 illustrates the three-step approach to calculate Fibonacci target prices for extensions.

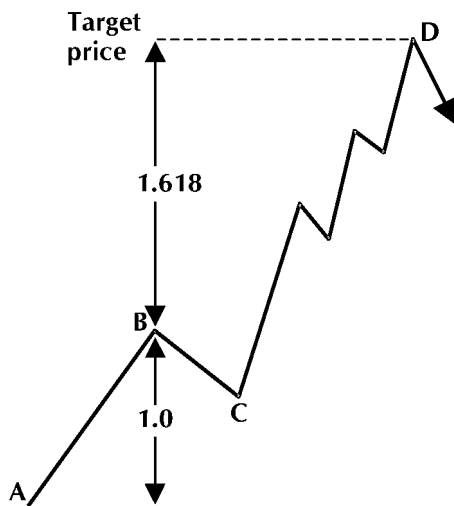

Figure 4.17 Extension in the third wave of a 3-wave pattern uptrend. Target price level measured by the Fibonacci ratio $\text{PHI} = 1.618$.

In general, we calculate price extensions based on the Fibonacci ratio 1.618. Those who want to extend the analysis to alternative ratios can do so by choosing appropriate ratios from the menu bar of the WINPHI software.

The application of Fibonacci price targets to extensions leads to three scenarios. Market prices can:

- Come close to the precalculated target price, but miss it by a small margin.
- Reach the exact target price.
- Overshoot the target price.

The most important variable in the analysis of extensions is the swing size; therefore, which scenario develops will depend on the strength of the selected impulse wave.

If the swing size is too small, the thrust of the extension may be too big and overshoot the precalculated price target by a wide margin. This makes the Fibonacci ratio 1.618 unreliable for calculating the

target price. Noise in the market can also cause underlying swings to become unpredictable. Even more important, a swing size that is too small can reduce profit targets to such narrow margins that it becomes difficult to execute them.

If the swing size is too big, it could take weeks, months, or even years to reach the target price. The bigger the selected swing size, the more long-term oriented the analysis must be, especially if the trader is using weekly price bar charts. When long-term price targets are reached, they will determine major turning points in the products analyzed. Price extensions calculated on large swings are of little use for average investors who invest with a short-term or mid-term time horizon.

In addition to the size of the impulse wave, a few other parameters determine a successful application of extensions.

Entry Rules, Stop-Loss Rules, and Profit Targets

The general idea behind extensions is to invest countertrend short or long once the target price of an upward or downward extension has been reached.

Integrating an entry rule makes it possible to fine-tune this countertrend investment strategy. Because we must deal with three scenarios, an entry rule is necessary to make the early stages of a market position more flexible and reliable.

The application of an entry rule slightly reduces the profit potential because positions are entered with a time lag after the target price has been reached. Trades become safer, however, because positions are protected from excessive losses if strongly rising or falling markets do not stop at precalculated price targets.

To properly handle the three aforementioned price target scenarios (being missed, reach the exact target price, or exceeded by some margin), the analysis must include small price bands above and below the line for the price target at the end of an extension. As long as the market price moves within the price band, the entry rule remains in effect. Should the market price exceed the upper price band, no action will be taken because it has to be assumed that market prices will rise higher without a correction countertrend.

Whenever a precalculated target price is reached on daily charts, we recommend working with an entry rule. This should be done in an uptrend either to the previous 2-day low, or to a market on close if the close of the last trading day is lower than the close of the highest day



within the price band (vice versa for long entries on price extensions to the downside).

Both patterns are shown in Figure 4.18.

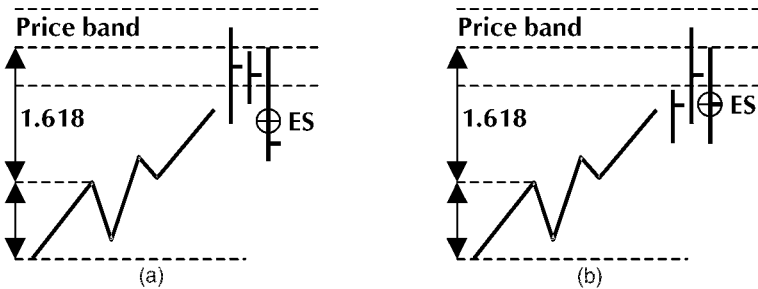

Figure 4.18 Entry rules out of a price band at the target price line of an extension.

The market itself decides the pattern that is realized. The one that shows up first will be filled.

Whenever a market position (long or short) is established, a stop-loss will protect it. The rule for short positions is to place the stop-loss protection one tick above the highest high of the previous bars. For long positions, the stop-loss rule is reversed: the stop-loss level is set to one tick lower than the lowest low of the previous bar.

Figure 4.19 shows the stop-loss rule after a short signal.

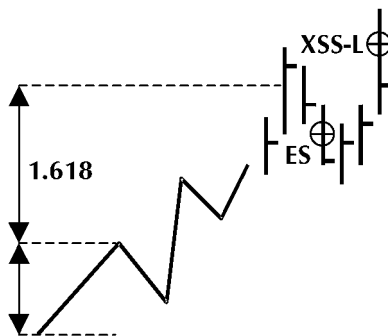

Figure 4.19 Stop-loss protection on a short position.

In addition to stop-loss protection, a profit target or a trailing stop rule maintains profits that accumulate on a position. The most common rules for daily data are:

- Profit target set to a 50 percent retracement of the previous 3-wave move that formed the extension.
- Trailing stop defined as a 3- to 4-day high/low breakout or a breakout of the previous peak/valley.

Each of the aforementioned exit rules has its advantages and disadvantages, but it is important to consistently stay with one rule.

Sample Calculations for Extensions on Daily Data

Because the Japanese Yen cash currency is a volatile product with high market participation, it is useful for demonstrating basic trade price extensions on daily data.

The following settings are used as our parameters in the Japanese Yen cash currency:

- Minimum swing size of 1.80 JPY (a sample move from 110.00 to 111.80); entry rule at previous 2-day high on buy signals, and previous 2-day low on sell signals.
- Price target calculated by multiplying the swing size of the first impulse wave by the Fibonacci ratio 1.618.
- Profit target 50 percent of the distance from impulse wave to price target; trailing stop set to 4-day low on buys and 4-day high on sells.
- Stop-loss level at highest high before entry on sells, and lowest low before entry on buys.

Applying these parameters to a chart, we conduct the analysis twice. We find four sample signals for the period from January to November 2000 on daily data.

In the first setup, we exit profitable positions as soon as the profit target level is reached. The 50 percent profit target level is



entered immediately after market entry as a limit order. We do not act until the market price triggers the profit target level (or the stop-loss, if the position turns to the negative). According to Table 4.7a, this strategy provides us with three wins and one losing trade.

Table 4.7a Calculation of Sample Signals in the Japanese Yen from 01-00 to 11-00 Exiting Positions with a Profit Target

High#/ Low# Reference	Entry Rule	At	Exit Rule	At	Profit/ Loss in Points
H#1/L#2	Entry buy	105.50	Profit target	107.60	2.10
H#3/L#4	Entry buy	105.65	Profit target	107.10	1.45
L#5/H#6	Entry sell	108.53	Stop-loss	109.38	(0.85)
H#7/L#8	Entry buy	106.45	Profit target	107.32	0.87

In the second setup, we use a trailing stop according to our definition and do not immediately close out positions at the profit target level. According to Table 4.7b, we also find three winning trades and one losing trade.

Table 4.7b Calculation of Sample Signals in the Japanese Yen from 01-00 to 11-00 Exiting Positions with a Trailing Stop

High#/ Low# Reference	Entry Rule	At	Exit Rule	At	Profit/ Loss in Points
H#1/L#2	Entry buy	105.50	Trailing stop	107.71	2.21
H#3/L#4	Entry buy	105.65	Trailing stop	108.53	3.88
L#5/H#6	Entry sell	108.53	Stop-loss	109.38	(0.85)
H#7/L#8	Entry buy	106.45	Trailing stop	106.70	0.25

Figure 4.20 shows the underlying chart pattern in the Japanese Yen cash currency including the four trading signals.



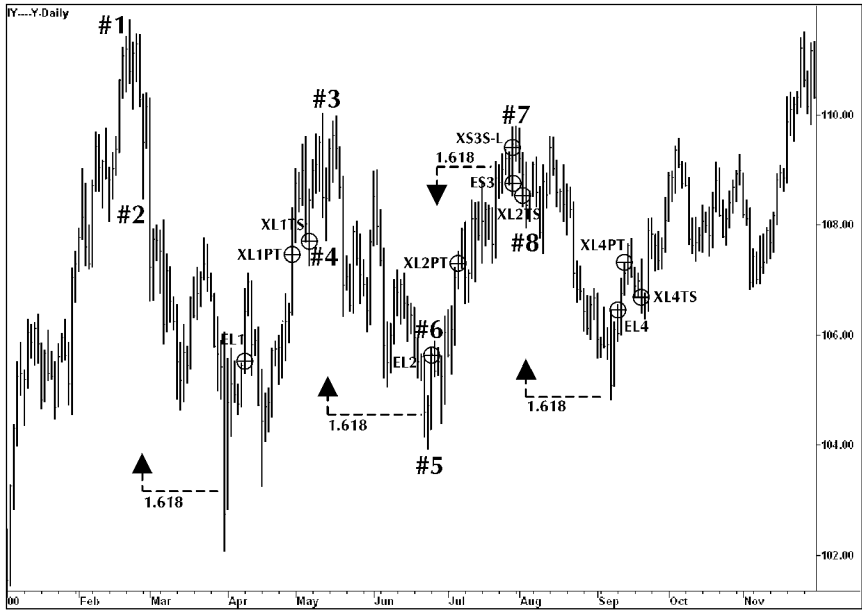

Figure 4.20 Japanese Yen chart from 01-00 to 11-00. Simulation of trading signals based on price extensions daily (EL: entry long, ES: entry short, XL: exit long, SX: exit short, S-L: stop-loss, PT: profit target, TS: trailing stop).

When the four sample trades are analyzed signal by signal, it becomes clear that trading price extensions can be a profitable strategy. Trading signals are infrequent, but the four occasions where market patterns were in accordance with our parameter settings offered convincing trading opportunities in the Japanese Yen cash currency.

Nevertheless, it is difficult to decide on the appropriate exit rule. Both options—exiting immediately on the profit target level, and waiting a little longer for the trailing stop pattern to close the position—paid off equally well. Interested readers can test both patterns on different sets of data, and within different time frames, to determine their personal preference.

Extensions out of 3-wave moves are the easiest patterns to identify, which is why we used this simple pattern in our introductory section.

In practical trading, however, most of the time, we must deal with multiple wave counts. Elliott based his principles on a 5-wave pattern, which is a static approach, but in strong bull or strong bear

markets, we often find 10 or more waves in the same trend direction. Normally, the wave count will not exceed 5 waves.

Price Extensions in 5-Wave Patterns

When analyzing extensions in 5-wave patterns, we look for an additional parameter, based on the Fibonacci summation series that will confirm our price target calculation for extensions out of a 3-wave pattern.

As explained earlier, to analyze a 3-wave pattern, the investor must multiply the size of the first impulse wave by the Fibonacci ratio 1.618. The product is then added to the swing size of the initial move to calculate a Fibonacci price target line. It is at this line that we expect the third wave to reverse.

Because there are usually more than three waves in a trending market, we must modify our approach to calculating a Fibonacci price target. The most common price pattern has at least five waves—three impulse waves and two corrective waves.

Figure 4.21 illustrates the basic approach to calculating price targets for extensions out of 5-wave market movements.

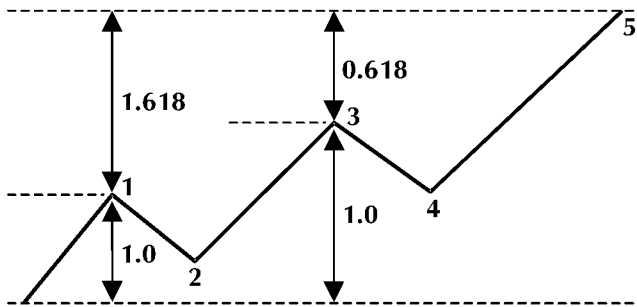

Figure 4.21 Calculation of Fibonacci price target in a regular 5-wave move.

In a regular 5-wave move in an uptrend, the price target line for the end of wave 5 is calculated by multiplying the amplitude of wave 1 by the Fibonacci ratio 1.618, and then multiplying the amplitude from the bottom of the wave to the top of wave 3 by the reciprocal value to the Fibonacci ratio 0.618.

By combining the two calculations, using ratios 0.618 and 1.618, we can precalculate the end of wave 5 at the same price if the market moves in a regular price pattern as described.

Most of the time, however, instead of finding one and the same price level calculated with both ratios, we get two different prices. They are either closer together or wider apart from each other, depending on the amplitude of wave 1 and wave 3. We find an upper and lower price target called a Fibonacci price target band.

We cannot know whether our price forecast will ever be reached, But we know in advance whether the price band will be close together or far apart. When the upper and the lower levels of the Fibonacci price target band are close together, the price target band is worth considering.

With the example of Japanese Yen cash currency shown in Figure 4.22, we show how to calculate a Fibonacci price band. Beginning with the high of wave 1 at 110.03 and the corresponding low at 107.72 multiplied by 1.618, we reach a price target of 103.99. The confirmation

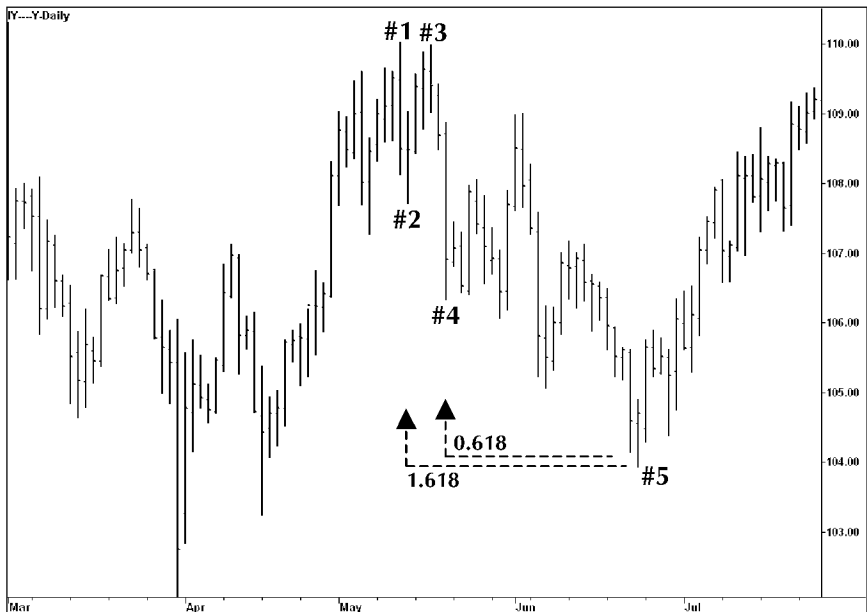

Figure 4.22 Japanese Yen chart from 03-00 to 07-00. Price target corridor calculated using the Fibonacci key ratios 1.618 to 0.618.

from the high of wave 1 to the low of wave 3, multiplied by 0.618, leads us to the second price target at 104.08.

The resulting Fibonacci price band is extremely narrow and is an ideal example of what we are looking for in the markets. The Japanese Yen cash currency dropped to 103.94 and then immediately reversed its trend direction to the upside.

Summary

Investing based on extensions always means investments against the main trend, which is defined by the first impulse swing in a 3-wave move or a 5-wave pattern.

Extensions are important Fibonacci trading tools because they not only show up in fast movements over a couple of days or weeks in soft commodities, but also indicate major trend changes in financial instruments, derivatives, or currencies.

The most important modification to the general calculation of extensions out of the 3-wave movement is the additional use of 5-wave patterns to get a multiple confirmation of a Fibonacci price target in a price band.

The successful combination of two Fibonacci-related tools is only one step toward using other Fibonacci trading tools that can identify turning points in the markets.

CANDLESTICK CHART PATTERNS

Candlestick chart patterns visualize accelerations and slowdown in trends—or indicate trend reversals.

Candlestick charts work with the same OHLC (opening, high, low, close) data as regular bar charts. The only difference is that a key-reversal-day on a bar chart, for example, can be easier to identify by looking for a hammer or a doji candlestick formation.

Candlestick charts are popular because they identify the momentum in a price move on every price bar by comparing the opening price with the closing price and showing black and white candlesticks, depending on whether the opening is higher or lower than the closing price.

Candlestick charts are very good trading tools by themselves, but they also combine well with other trading tools.



Basics of Working with Candlestick Chart Patterns

Working with candlesticks means that there is no time lag in the analysis compared with technical analysis tools (e.g., moving averages).

Candlesticks show everyday investor behavior expressed through the relationship of open, high, low, and close of the day (or week, month, etc.).

The following candlestick chart patterns occur frequently and combine well with Fibonacci trading tools. Our goal is to be practice-oriented—to show what works, is easy to understand, and is useful for all traders. The few candlestick patterns we show here represent probably 80 percent of all valid patterns in real-time everyday trading and can be easily integrated with other strategies.

Generating Trading Signals Based on Candlestick Patterns

Hammer and Hanging Man (Inverted Hammer)

A candlestick chart pattern is called a hammer if it has a long shadow and a small body (black or white) that is very close to the high of the day. At the end of a downtrend, the hammer is considered a bullish reversal signal (see Figure 4.23).

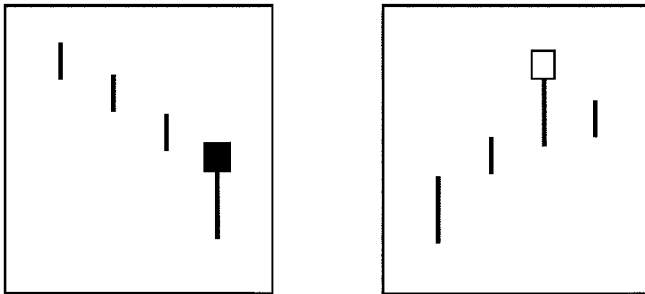

Figure 4.23 Hammer and hanging man.

The hammer often shows up at the end of a downtrend. After we identify a hammer, we buy next day at the high of the previous day. The stop-loss is below the low of the previous day.

The corresponding candlestick chart pattern of a hanging man is a hammer at the end of an uptrend. We sell on the occurrence of this

chart pattern if the low of the day with the hanging man is broken. The stop-loss in this case is the high of the day at which the hanging man pattern has occurred.

Bullish and Bearish Engulfing Patterns

Whereas hammer and hanging man are single candlestick formations (consist of one candlestick), the bullish and bearish engulfing patterns need a pair of candlesticks to complete the pattern (see Figure 4.24).

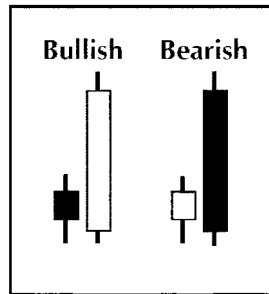

Figure 4.24 Bullish and bearish engulfing pattern.

The bullish engulfing pattern often occurs at the end of a downtrend and indicates a trend reversal. We buy at the high of the day with the big, white candlestick. The stop-loss is placed below the lowest low of the small or big candlestick, whichever is lower.

The bearish engulfing pattern often occurs at the end of an uptrend. The sell signal is at the low of the long black candlestick. The stop-loss is placed above the highest high of the small or big candlestick, whichever is higher.

Harami Pattern

The harami pattern is only an indication of a trend change at the end of an uptrend or downtrend. Harami patterns do not have relevance in sideways market conditions. Harami patterns always include two candlesticks, which can be compared with inside days in the regular chart analysis.

The harami pattern has a small body (black or white) that fits completely into the big (black or white) body of the previous day. It is

unimportant whether the shadow of today's small candlestick pattern goes higher or lower than the shadow of the previous candlestick (see Figure 4.25).

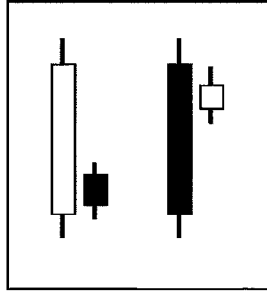

Figure 4.25 Harami pattern.

At the end of a downtrend, we get a buy signal if the high of the candlestick with the big white body is broken. The stop-loss is placed at the low of that particular day.

If the low of the candlestick with the big black body is broken, we receive a sell signal at the end of an uptrend. The stop-loss is placed at the high of that particular day.

Morning Star and Evening Star

Morning star and evening star are chart patterns that comprise three candlesticks (see Figure 4.26).

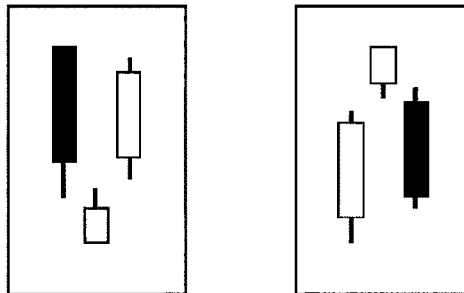

Figure 4.26 Morning star and evening star.

The morning star pattern indicates an uptrend market movement. We buy at the high of the right candlestick with the long white

body. The stop-loss is placed at the low of the small candlestick in the middle of this pattern.

An evening star indicates a downtrend. We sell at the low of the right black candlestick. The stop-loss is placed at the high of the small candlestick in the middle of this pattern.

Sample Trading Signals

We show trading signals based on candlestick chart patterns for the DJ EuroStoxx 50 Index between June and August 2002.

Three months is a short time span. However, it is sufficient for demonstration purposes because candlestick charts need a lot of space. This time period is identical with the Fibonacci price correction analysis presented earlier in this chapter, and later on, we combine the two approaches. Figure 4.27 shows seven candlestick trades over the three months under consideration.



Figure 4.27 DJ EuroStoxx 50 chart from 06–02 to 08–02. Simulation of trading signals based on candlestick patterns daily (EL: entry long, ES: entry short, XL: exit long, SL: stop-loss).

The large market swings in the DJ EuroStoxx 50 Index mean they work very well for analysis with candlestick charts. With smaller market swings, candlesticks do not work as well. The same holds true for Fibonacci analysis. Candlesticks and Fibonacci corrections have much in common. In both strategies, the core principle is a focus on investor behavior.

Signal 1

The first signal is based on a harami pattern and is confirmed in addition by a bearish engulfing pattern.

The sell signal is at the low of the long white candlestick. Because the market opened with a price gap, the entry price is even lower than the low of the long white candlestick.

Signal 2

The second trading signal is a long signal based on a bullish engulfing pattern.

As there is no reversal signal, we get stopped out at the lowest low of the bullish engulfing chart pattern.

Signal 3

The third signal is a perfect hammer pattern. The candlestick body is very small and the shadow is at least three times longer than the body.

We buy at the opening of the day following the hammer candlestick pattern.

Signal 4

After the long white candlestick body, we identify a harami pattern. The bearish signal of the harami pattern is confirmed by an inverted hammer pattern, with a long shadow on the top and a small body at the bottom.

We sell at the opening of the day that follows the harami pattern.

Signal 5

We get a reversal buy signal based on a bullish engulfing chart pattern.

We buy on the next day when the high of the candlestick with the long white body is broken.



Signal 6

If we are a little flexible, we can see an evening star chart pattern in the sixth signal. It would be a perfect pattern if the body of the small white candle showed a gap to the candlestick bodies to the left and to the right.

The sell signal is at the lowest low of the candlestick with the black body to the right.

Signal 7

The seventh signal is based on a very rare candlestick pattern, a so-called tri-star bottom. Since it shows up so seldom, we did not describe it in our presentation of candlestick chart patterns. The tri-star bottom pattern looks very much the same as a morning star. The only difference is that all three candlesticks are dojis.

We get a buy signal at the high of the right doji chart pattern.

A Tabular Summary of the Trading Signals

Table 4.8 provides a summary of all seven trading signals.

Table 4.8 Trading Signals

#	Entry Rule	At	Exit Rule	At	Profit/ Loss in Points
1	Sell short	3,042.00	Buy reverse	2,828.00	214.00
2	Buy reverse	2,828.00	Stop-loss	2,612.00	(216.00)
3	Buy long	2,552.00	Sell reverse	2,661.00	109.00
4	Sell reverse	2,661.00	Buy reverse	2,612.00	49.00
5	Buy reverse	2,612.00	Sell reverse	2,676.00	64.00
6	Sell reverse	2,676.00	Buy reverse	2,708.00	(32.00)
7	Buy reverse	2,708.00			Open

The ratio of four winning trades and two losing trades (with one of the positions still open) is a promising indication of how powerful candlestick chart patterns can be as stand-alone trading strategies.

Summary

A major advantage of candlesticks is that they show the momentum of every day's price moves. They are definitive, easier to understand than bar charts, and especially helpful for short-term traders.



The usefulness of candlesticks as stand-alone trading tools has to be judged carefully. Our own simulation on the DJ EuroStoxx 50 Index came up with a solid profit potential and a decent profit/loss ratio over a 3-month test period in mid-2002.

However, negative test results were retrieved from Rogalski Trading, Germany, using the most common candlestick patterns on the Dax 30 Futures Index and the Euro-Bund Future over a longer time period. The test runs conducted by Rogalski Trading were based on the following parameters:

- Dax 30 Futures Index tested from March 1997 to February 2001.
- Euro-Bund Future tested from January 1994 to February 2001.
- Entry rule on stop at the candlestick pattern high price or low price, or market on open of the following trading day, whichever comes first.
- Exit rule market on the daily close after day 1 or on the daily close after day 3.
- Slippage and commission calculated as 2 basis points in both, the Dax 30 Futures Index and the Euro-Bund Future.

The test results by Rogalski Trading for selected candlestick chart patterns and based on the 1-day close and 3-day close exit rule lead to a profile that leaves some room for interpretation and speculation.

Rogalski Trading have investigated seven candlestick patterns. The findings for four of the patterns are summarized in Table 4.9.

Table 4.9 Simulation of Trading Signals Based on Candlestick Chart Patterns Daily (BE: Bullish Engulfing, MS: Morning Star, HM: Hanging Man, HA: Hammer)

	BE (1)	BE (3)	MS (1)	MS (3)	HM (1)	HM (3)	HA (1)	HA (3)
Dax 30	36	256	(509)	(285)	(373)	210	42	342
Bund	(1.74)	0.34	(1.74)	4.25	4.67	6.72	(1.33)	3.14

Source: Rogalski Trading, by Andre Rogalski, Berlin, Germany, 2000.



The three candlestick formations that are missing from the Rogalski Trading simulation in Table 4.9 are bearish engulfing pattern, evening star, and dark-cloud cover.

Figure 4.28 shows total profits and losses for all seven candlestick patterns in the Dax 30 Futures Index and the Euro-Bund Future in a line and bar combo graph.

The overall results lead us to conclude that candlestick chart patterns as stand-alone trading tools are not reliable enough for trading.

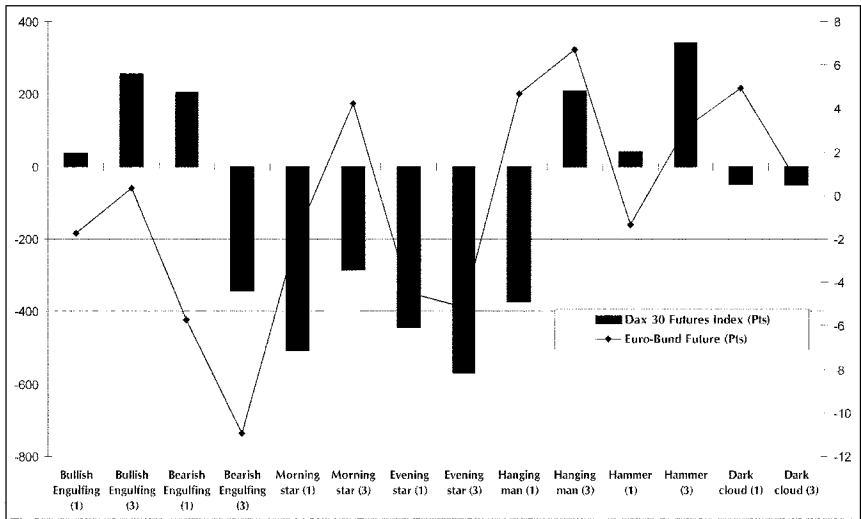

Figure 4.28 Dax 30 Futures Index and Euro-Bund future performance from 1997 and 1994 to 2001. Simulation of trading signals based on candlestick patterns daily. Source: Rogalski Trading, by Andre Rogalski, Berlin, Germany, 2001.

The only patterns with profit potential are bullish engulfing pattern, hammer, and hanging man on the Dax 30 Futures Index, but not on the Euro-Bund Future. Liquidating the position after a 3-day holding period is more profitable than after a 1-day holding period. Because the performance of the Dax 30 Futures Index is similar to that of the S&P 500 Futures Index, the test results can be related to the S&P 500 Futures Index as well. The same holds true for the relationship of Euro-Bund Future and U.S. Treasury Bonds.

However, even though the candlestick chart patterns do not offer a big trading potential by themselves, they can be of high value for short-term traders by instantly alerting them when the momentum in a product or market is changing.

In addition to the analysis conducted by Rogalski Trading, another study by Giovanni Maiani* is from our point of view the best summary to be found in this field. In order to quantify the reliability of Japanese candlestick formations, Maiani analyzed first 575 American stocks and bonds over a period of 15 to 20 years from the early 1980s to present using Metastock definition of candlestick patterns. Each candlestick formation observed the trend starting from the day after the formation occurred. He looked for about 40 patterns and tabulated each trend's subsequent rise, decline, or neutral movement. The goal was to get the statistical percentage on the most reliable formations.

Maiani found more than 6.14 million candlestick formations. This number may be unusually high, however, some of the simple formations such as the inverted hammer were counted twice if they became part of a multi-candlestick formation. Counting both, simple and compound candlestick formations, offers a complete, detailed, and effective analysis.

The ten most frequent and the ten least common candlestick formations shall be displayed in tabular form. Information is presented for each candlestick formation on the percentage of the total found and the percentage of cases in which the candlestick formation preceded a rise, fall, or sideways movement on the following day.

The most frequent patterns are white body, hammer, and black body. From Figure 3.16 in the previous chapter, readers get an idea what white body and black body candlestick patterns look like. In each case it is the big white or black body with the small shadows at the top and at the bottom. The white body is the most common candlestick with more than two million occurrences. This represents 32.6 percent of the total. Second and third most common are the hammer and the black body, with 12.6 percent and 12.1 percent of the total. Among the least frequent candlesticks are morning and evening star doji, evening star, and morning star (Table 4.10).

* Giovanni Maiani, "How Reliable Are Candlesticks?" In *Technical Analysis of Stocks & Commodities* (November 2002), pp. 60–65. Further references will cite Maiani.



Table 4.10 Most Frequent and Least Common Candlestick Chart Formations

	#	%	% of Day After		
			Up	Down	=
White body	2,003,843	32.60	44.02	43.85	12.12
Hammer	776,772	12.60	40.86	45.71	13.42
Black body	741,653	12.10	45.89	46.06	8.01
Long upper shadow	531,103	8.60	44.45	41.60	13.94
Inverted hammer	450,521	7.30	46.91	41.22	11.86
Tweezer bottoms	255,030	4.20	39.92	40.08	20.00
Tweezer tops	242,824	4.00	40.51	40.49	19.00
Doji	171,945	2.80	42.28	42.48	15.22
Long white body	139,147	2.30	45.90	46.25	7.83
Spinning top	134,383	2.20	46.93	47.93	5.08
Dark cloud cover	4,839	0.08	48.75	44.31	6.90
Bearish harami	3,052	0.05	43.55	50.82	5.57
Bullish harami	2,162	0.04	48.43	47.09	4.49
Long-legged doji	1,318	0.02	42.15	41.93	15.85
Three white soldiers	235	0.00	35.74	53.62	10.64
Morning star doji	205	0.00	48.78	43.90	7.32
Evening star doji	180	0.00	40.56	53.33	6.11
Evening star	157	0.00	48.41	48.41	3.18
Morning star	150	0.00	47.33	50.67	2.00
Three black crows	102	0.00	67.65	27.45	4.90

Source: Maiani, p. 60.

The last three columns in Table 4.10 show how many up, down, and neutral days followed a candlestick formation. In 44.20 percent of the cases, a white body anticipated a rising session, in 43.85 percent of the cases a decline occurred, and in 12.12 percent of the time the price did not change. The percentage of up days is almost the same as the down days.

The most reliable patterns are three black crows, inverted black hammer, and inverted hammer. Maiani's findings are in line with our own results when he writes: "For traders who are quantitatively based, candlestick patterns are not terribly useful, while they are very useful to those who are more visual in nature" (Maiani, p. 65). A little later in his article, Maiani continues: "The distribution of candlestick patterns, at least for the most commonly occurring, has been consistent over time and through different markets. These three patterns are the white body, hammer, and black body. The analysis done



in this article shows the reliability of these formations. When used in combination with indicators and other patterns, they can be a very powerful tool” (Maiani, p. 65).

The biggest advantage for traders becomes obvious by combining candlestick formations with Fibonacci trading tools and regular 3-point chart patterns. Useful combinations of all three trading components are described in the final chapter of this book.

3-POINT CHART PATTERNS FOR TREND REVERSALS

The always hot and new question that analysts and traders ask themselves is when price moves come to an end and change direction.

There are many ways to approach this problem with technical analysis. Traders have identified hundreds of chart patterns and formations. In this section, we concentrate on the ones that have at least three peaks or valleys on one side of the chart pattern. This restriction eliminates many of the popular formations, but it reduces the number of trades and makes it much easier to identify chart patterns.

Our approach comes very close to the wave count from Elliott. In contrast to Elliott, however, who counted three impulse waves and two corrective waves in an uptrend or downtrend for a complete price move, we focus on the total number of five waves. It makes little difference whether the market moves up, down, or sideways. After 5 waves, the market price often changes its direction, no matter whether it is a trending pattern or a sideways pattern. The only difference is the profit potential. As long as traders rely on precalculated profit targets, a buy or sell signal at the end of a sideways pattern might even be safer than at the end of a 5-wave uptrend or downtrend.

Even more important is that we can combine the 3-point chart patterns with Fibonacci trading tools or candlestick chart patterns. This combination separates our approach from many other strategies available in this field.

Most knowledgeable books on the topic of pattern recognition were written decades ago. However, Thomas N. Bulkowski has written two books* that go far beyond the content of competing books. The

* Thomas N. Bulkowski, *Encyclopedia of Chart Patterns* (New York: John Wiley & Sons, 2000). Further references will cite Bulkowski; Thomas N. Bulkowski, *Trading Classic Chart Patterns* (New York: John Wiley & Sons, 2002).



Encyclopedia of Chart Patterns and *Trading Classic Chart Patterns* provide detailed computer studies for many chart patterns that were tested on 500 stocks and backward for five years. Bulkowski writes:

To knowledgeable investors, chart patterns are not squiggles on a price chart; they are footprints of the smart money. The footprints are all they need to follow as they line their pockets with greater and greater riches. They are the one making the footprints. They are the smart money that is setting the rules of the game—a game anyone can play. It is called investing. (Bulkowski, p. 3)

We recommend this book to anyone who is interested in chart patterns. In the following discussion of selected patterns, we refer to Bulkowski's key studies.

Applying 3-Point Chart Patterns

This discussion of important price chart patterns is subdivided into reversal patterns and continuation patterns, but it is important to understand that these two categories might not always be correct. A head and shoulder formation is generally considered to be a reversal price pattern, but in rare situations it may show up as a continuation pattern. Traders have to be aware of this complication.

Stop-Loss Rules

A general stop-loss rule applies immediately after market entry. It states that we place the stop-loss on a close above or a close below the highest peak (sell signals) or lowest valley (buy signals) of the chart pattern we are working with.

Figure 4.29 illustrates the general stop-loss rule on a long and a short position.

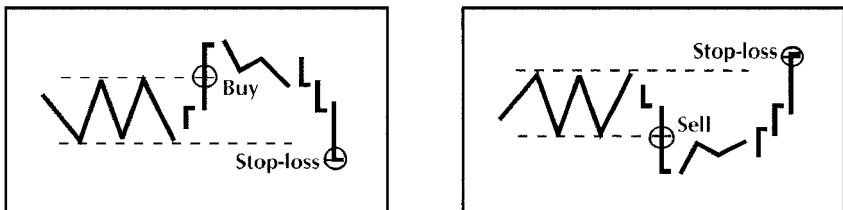

Figure 4.29 Stop-loss rule.

However, there are exceptions to this rule. These are described in the later discussion of specific chart patterns.

Profit Target Rules

There are several ways to work with profit targets on long and short positions.

Some basic calculations can provide easy-to-follow profit target rules that have proven to be successful in various market situations:

- Price projections based on Fibonacci ratios.
- Parallel trend lines.
- Total length of the first impulse wave (with reference to the Elliott count).
- Doubling the total distance of the price pattern from highest high to lowest low.

Figures 4.30a to 4.30d show the preceding options for predefining profit targets on a long entry.

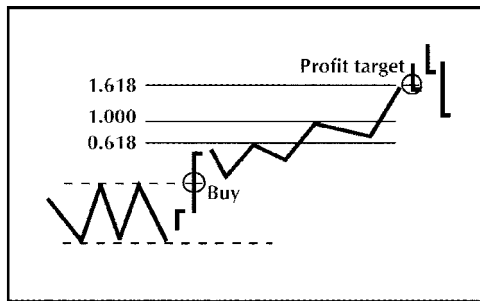

Figure 4.30a Profit target rule (ratios).

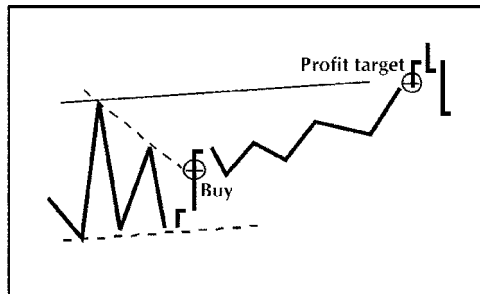

Figure 4.30b Profit target rule (doubling distance)

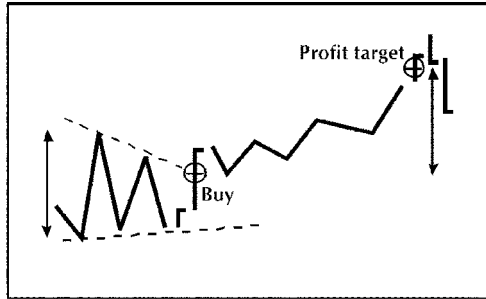

Figure 4.30c Profit target rule (impulse wave).

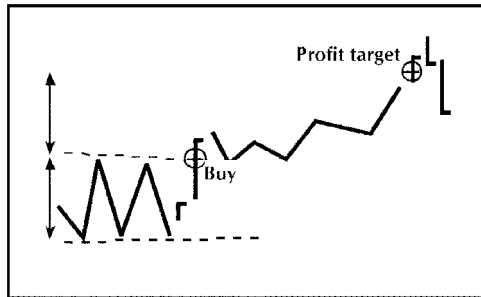

Figure 4.30d Profit target rule (double distance from highest high to lowest low).

Trailing Stop Rules

To protect open profits, we can apply trailing stops in different ways. As long as the market moves in a narrow trading range, we can protect small profits by working with a 3- to 4-day previous high (short positions) or low (Figure 4.31).

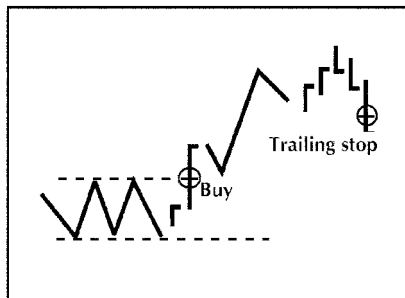

Figure 4.31 Trailing stop rule (3- to 4-day previous high or low)

Even though this approach is effective for the short term, large profits cannot accumulate in a single product, for we get stopped out too quickly. The most commonly used trailing stop rule is to work with previous peaks or valleys. This approach works less well when a product is in a trading range, but it opens up the opportunity for bigger profits in trending market situations.

Figures 4.32a and 4.32b show the valley/peak trailing stop rule out of a long and a short position.

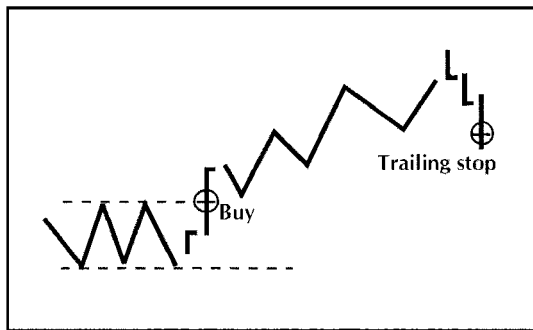

Figure 4.32a Trailing stop rule on a valley out of long position.

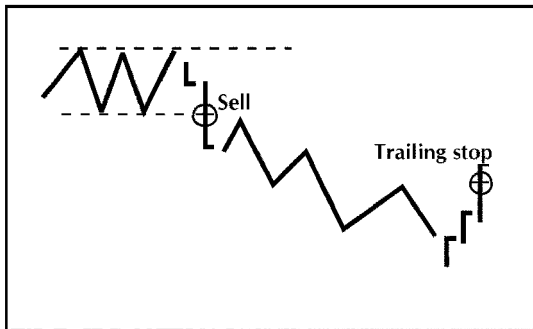

Figure 4.32b Trailing stop rule on a peak out of short position.

Examples with Selected 3-Point Chart Patterns

The chart patterns discussed in the following subsections are well known, and more importantly, they are highly relevant to combinations with candlestick patterns and Fibonacci trading tools. Our findings are in line with the results of Thomas Bulkowski's computer test

runs. In Chapter 6, we use the same examples to show how traders can modify our entry rules by integrating candlestick charts and Fibonacci trading tools.

Head and Shoulder Formation

Head and shoulder formations are one of the best chart patterns for locating trend reversals. They often can be found on tops or bottoms, but there are exceptions. A head and shoulder top formation is sometimes at the end of a downtrend as well. Ideally, the right shoulder should be on the same level as the left shoulder.

Figure 4.33 shows the German Dax member stock BMW.

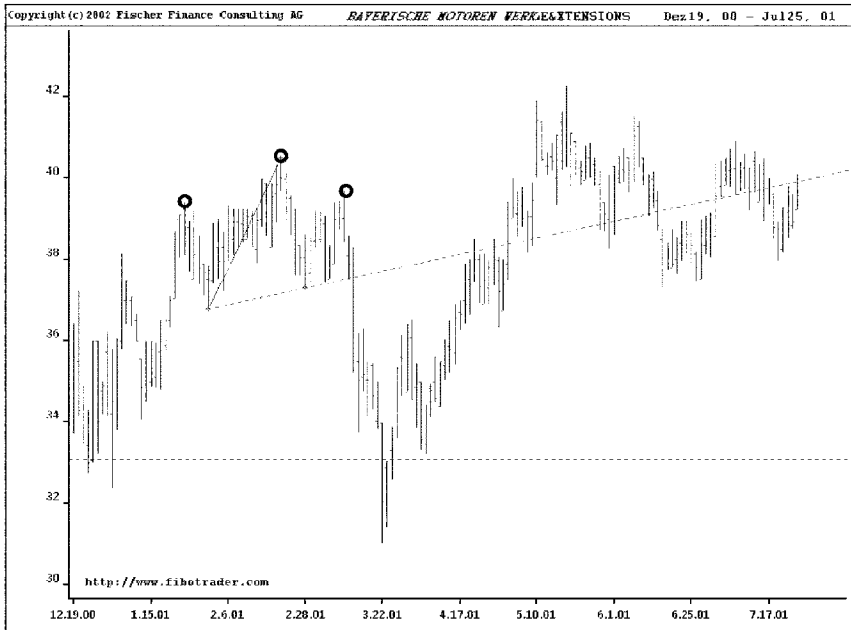

Figure 4.33 BMW chart from 12-00 to 07-01. Head and shoulder formation daily.

On this chart, the neckline connects two valleys between the left and right shoulder of a head and shoulder top formation. At the bottom formation, the neckline connects the two peaks between the right and left shoulder. To complete the formation, the market price must break the neckline.

Figure 4.34 shows a head and shoulder formation for Eastman Kodak from late in the year 2001.

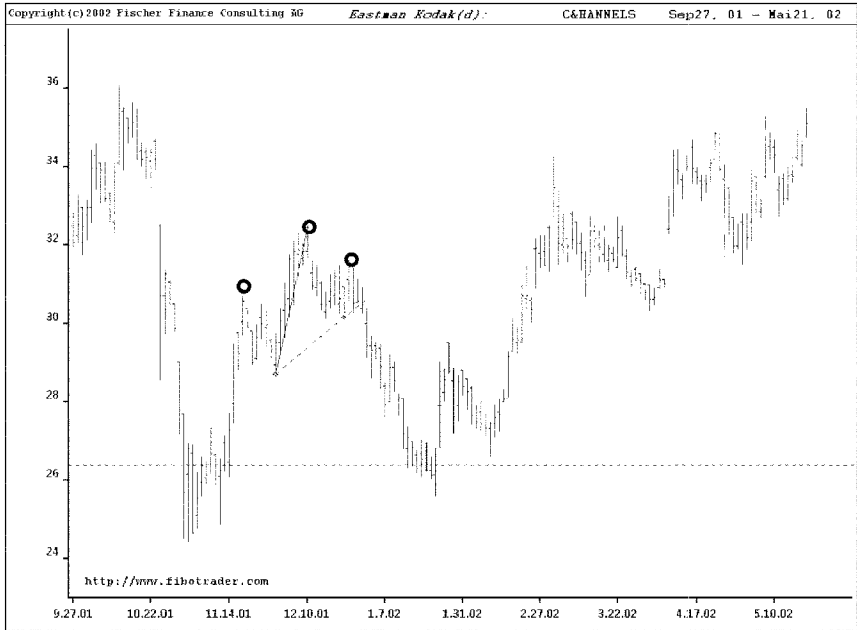

Figure 4.34 Eastman Kodak chart from 10–01 to 04–02. Head and shoulder formation daily.

To successfully make trades based on price chart patterns, we need to check the profitability of our entry rules, stop-loss rules, profit target, and trailing stop rules.

Once the right shoulder is formed, we can buy (or sell) on a breakout of the neckline to the upside (or to the downside). With a head and shoulder top formation, the success rate of this approach is 93 percent according to Bulkowski's test results.

The stop-loss is placed just above (short trades) or below (long trades) the right shoulder. Setting the profit target to twice the

distance of the price pattern from high to low leads to success rates of 83 percent for head and shoulder bottom formations and 63 percent for head and shoulder top formations (according to Bulkowski). In our experience, the peak or valley breakouts described here work best as profitable trailing stop exits.

Triple Tops and Triple Bottoms

Triple top and triple bottom formations are reliable 3-point chart patterns. All three of the tops or bottoms need to be placed almost on a horizontal line to show as a valid triple top or triple bottom pattern. The three bottoms are usually large and well separated from each other.

A triple bottom chart formation for Nokia as of mid-2002 appears in Figure 4.35.

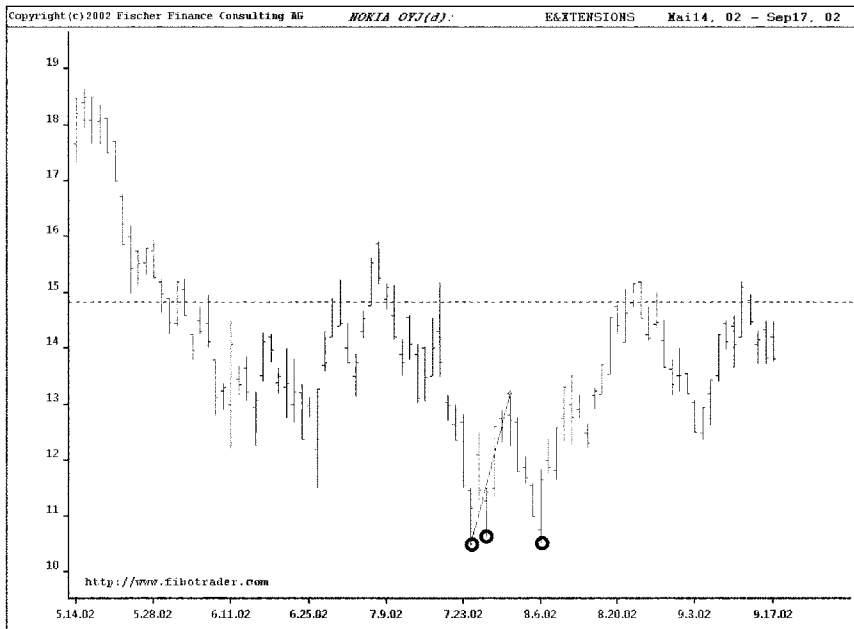

Figure 4.35 Nokia chart from 05–02 to 09–02. Triple bottom formation daily.

In general, triple tops and triple bottoms are rare chart patterns. Figure 4.36 shows another of these unusual but profitable formations—an impressive triple bottom pattern on an IBM chart from mid-2002.

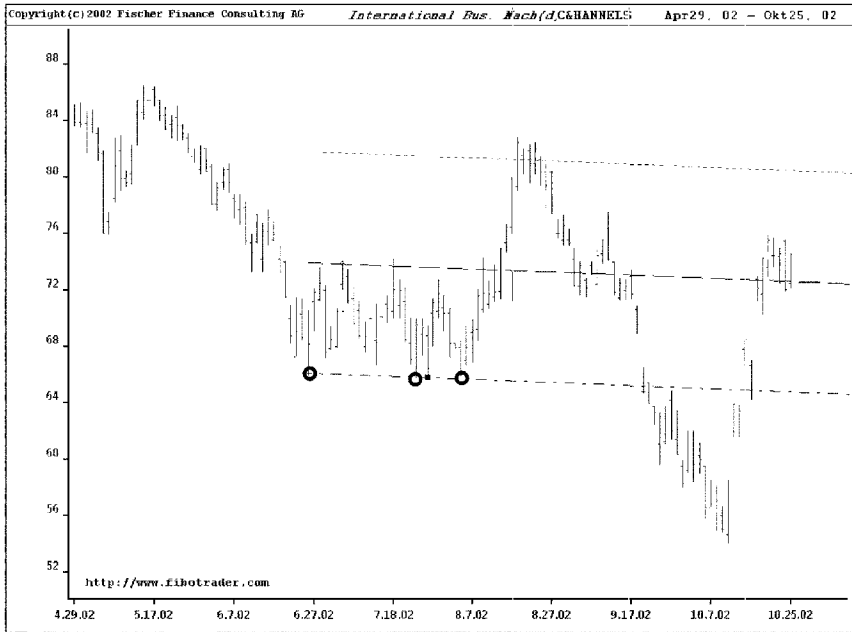

Figure 4.36 IBM chart from 05-02 to 09-02. Triple bottom formation daily.

To enter the market, prices must break out of the highest high or the lowest low over the time span of the development of the triple bottom or top formation.

The stop-loss point is set to the highest high (for sell signals) or the lowest low (for buy signals) of the chart formation.

The profit target is defined by doubling the distance between the lowest low and the highest high of the chart formation. Using a similar profit target rule, Bulkowski concludes that 73 percent of his pre-calculated price targets are reached out of triple bottoms, whereas only 47 percent of the targets are reached out of triple tops.

As soon as profits start accumulating, a trailing stop rule can replace a profit target rule. Again, the simple rule of using the most

recent peak in a profit (on short signals) or the most recent valley in a profit (on long signals) is a successful strategy.

Rectangle Formations

Rectangles can be at the top or the bottom. Prices oscillate between two horizontal trend lines before breaking out.

Rectangle formations are very reliable. Bulkowski found just two failures (losing trades) for rectangle bottoms out of 95 formations in his test runs. For rectangle tops, the ratio shows five failures in nearly 300 rectangles tested. If the rectangle is wide enough, trading counter-trend within the rectangle can be a smart short-term strategy.

Figure 4.37 depicts a chart of the Japanese Yen cash currency against the U.S Dollar (Figure 4.37).

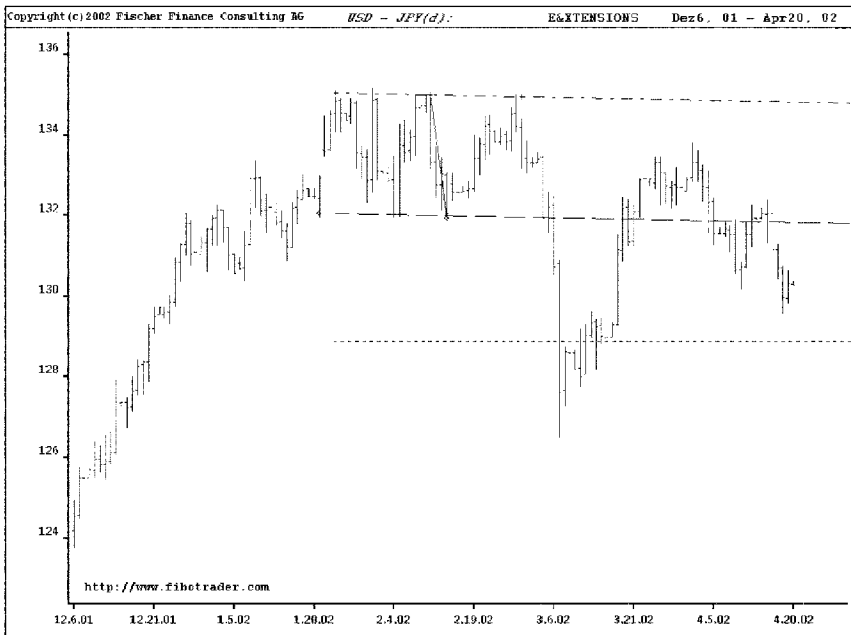

Figure 4.37 Japanese Yen chart from 12-01 to 04-02. Rectangle formation daily.

There is likely to be a pullback after the breakout from the rectangle. Should this happen, we can build up additional trading positions. This strategy works for rectangle bottoms and rectangle tops.

Another picture-book example of a rectangle formation is the Intel stock in July and August 2002 (see Figure 4.38).

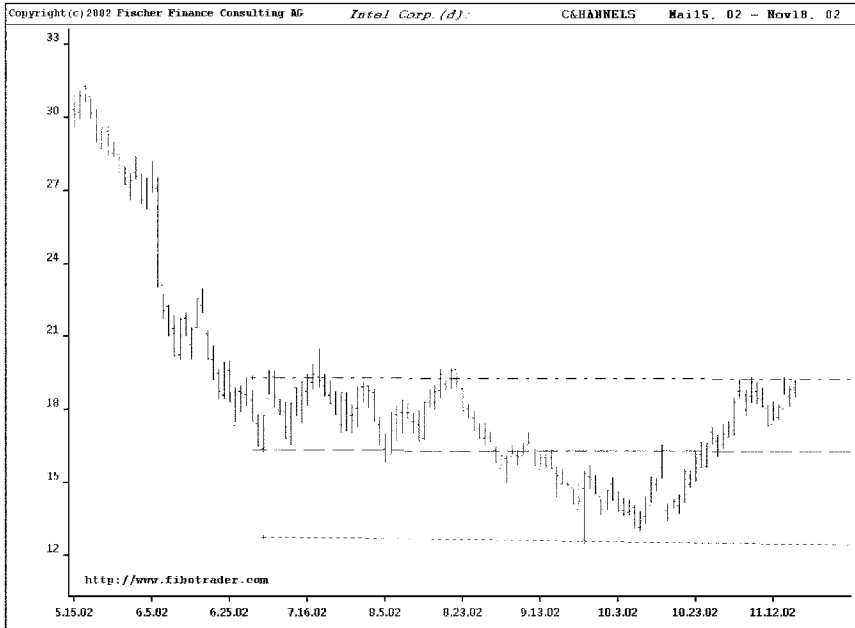

Figure 4.38 Intel chart from 05–02 to 11–02. Rectangle formation daily.

Since we cannot predict the breakout direction, we wait for the market price to close outside the rectangle trend lines and then trade in the direction of the main trend.

The stop-loss can be placed first at the median line of the rectangle. If the market price after we have entered a position forms a peak or valley inside the trend lines of the rectangle, this peak or valley is the indicator for the stop-loss.

We set our profit target by doubling the distance from highest high to lowest low of the rectangle. In results presented by Bulkowski on a comparable exit rule, 93 percent of his predicted price targets for breakouts to the upside out of rectangle bottoms proved to be accurate. Breakouts to the downside reached the profit targets at a 65 percent rate. The figures for rectangle tops were 91 percent (upside breakouts) and 77 percent (breakouts to the downside).

Finally, we recommend using a trailing stop rule, defined simply as the most recent peak or valley in a profit. In the end, however, the investor's mentality toward risk will determine whether to use profit targets, trailing stops, or a combination.

Key-Reversal Days

Key-reversal days often occur at the end of a fast-moving market either up or down.

We know from the analysis of the hammer candlestick chart pattern that the overall statistics are poor for that particular pattern, which is equivalent to a key-reversal day. Nevertheless, we concentrate on those key-reversal days that happen as third peaks or valleys within a chart pattern.

A typical example can be seen in the daily chart of the largest European software company SAP (see Figure 4.39).

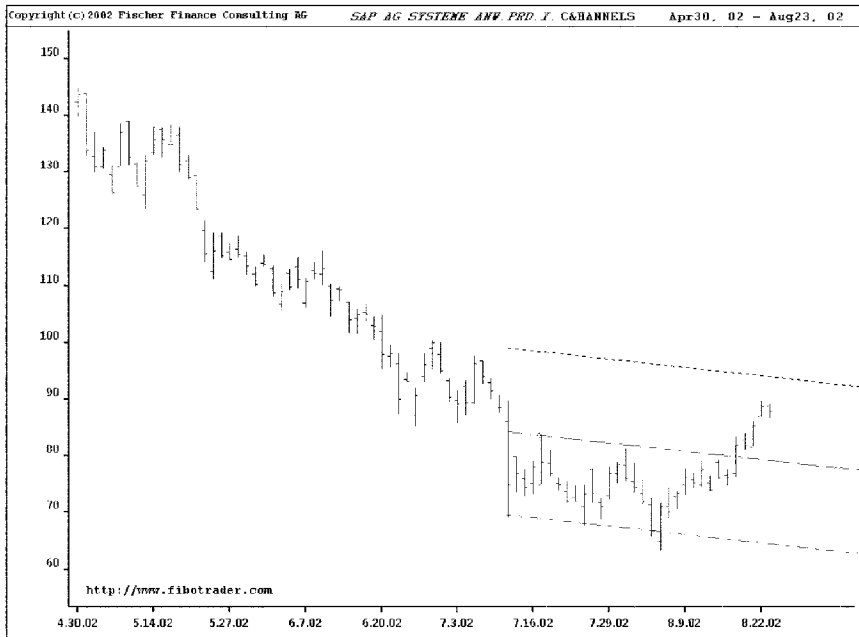

Figure 4.39 SAP chart from 04-02 to 08-02. Key-reversal day.

Intel again provides an example; it shows a solid key-reversal day pattern as a third peak in a triple top formation, this time late in August 2000 (Figure 4.40).

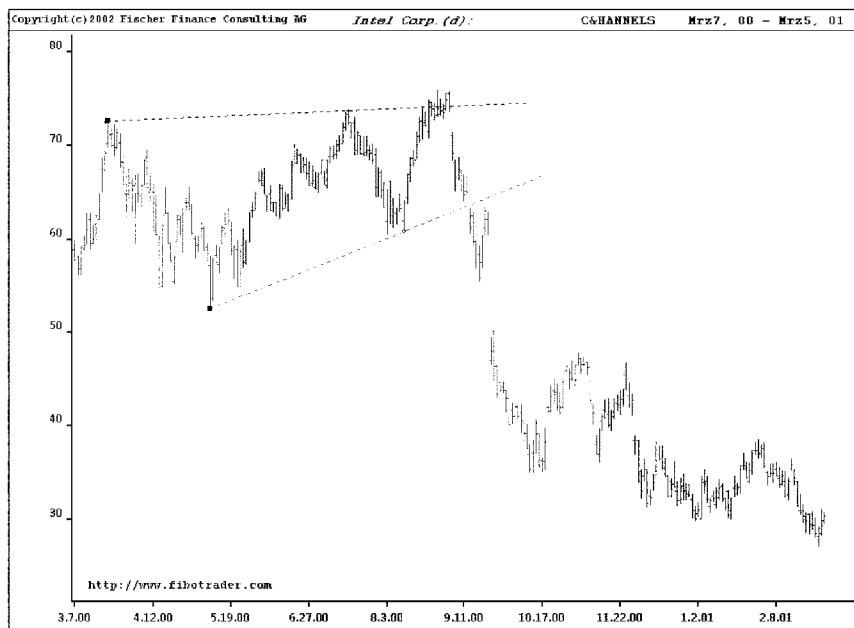

Figure 4.40 Intel chart from 03-00 to 12-00. Key-reversal day.

The entry rule depends to a high degree on the risk preference of the investor. An ideal pattern is the hammer candlestick chart formation, described in an earlier section. An easy rule of thumb is that the shadow of the hammer should be at least three times the length of the body.

The stop-loss is placed at the low of the key-reversal day for a buy signal and at the high of the key-reversal day for a short signal.

Often on key-reversal days, we are already in a trading range at the third peak or valley of a 3-point chart formation. For short-term trades, we take the opposite side of the trading range as our first profit target and double the distance of the trading range as our second profit target.

Trailing stop rules are less important for key-reversal days and short-term approaches to trading.



Three Rising Valleys and Three Falling Peaks

Three rising valleys and three falling peaks are among the most stable and reliable 3-point chart patterns.

The general pattern consists of either three valleys with two peaks in between or three peaks with two valleys in between. In contrast to the other 3-point chart patterns described thus far in this section, three rising valleys and three falling peaks are trend-following patterns and do not indicate trend reversals. We get a short signal at the low of the lowest valley and a buy signal at the high of the highest peak.

It is essential to keep in mind the distinction between 3-point chart patterns indicating trend changes and 3-point chart patterns indicating continuing trend movements. We refer to this distinction again in the following section on triangles.

Figure 4.41 shows a 6-month bar chart of the DaimlerChrysler stock.

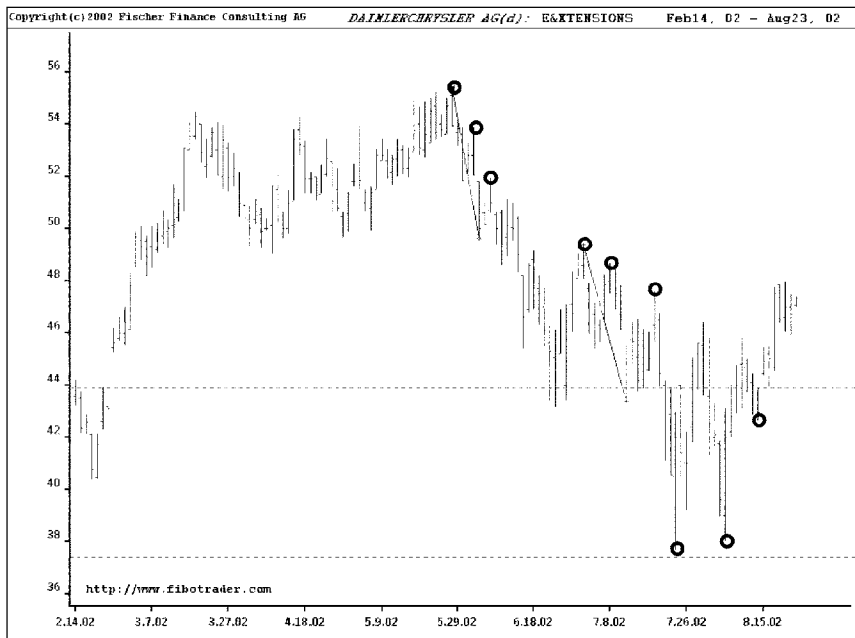

Figure 4.41 DaimlerChrysler chart from 02–02 to 08–02. Chart patterns of three falling peaks and three rising valleys.

The Japanese Yen cash currency against the U.S. Dollar provides another chart example of three falling peaks as a solid basis for a short market entry (see Figure 4.42).

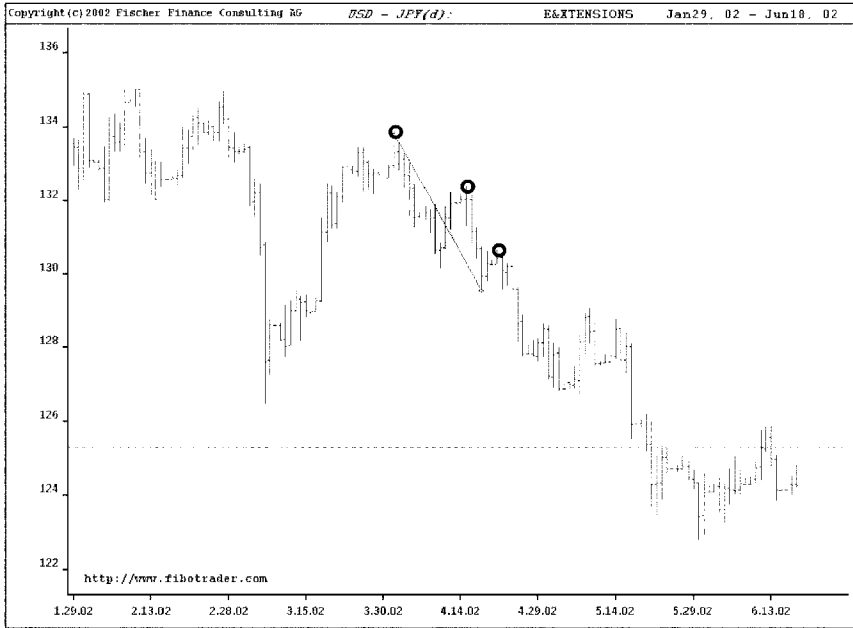

Figure 4.42 Japanese Yen chart from 02–02 to 06–02. Pattern of three falling peaks.

For market entries, we sell at the lowest intermediate valley (three falling peaks) or buy at the highest intermediate peak (three rising valleys) of the 3-point chart formation. Reminder: The respective chart formations of falling peaks and rising valleys always consist of either three peaks and two intermediate valleys or three valleys and two intermediate peaks.

The stop-loss is placed at the most recent peak above (short positions) or at the most recent valley below (long positions) our entry point.

The profit target works again as doubling the distance from highest high to lowest low of the 3-point chart formation.

Our trailing stop rule also is the same one that we have already used several times in this chapter. We buy flat at the most recent peak

in a profit (short positions) or sell flat at the most recent valley in a profit (long positions).

Symmetrical, Ascending, and Descending Triangles

Triangles are the final 3-point chart pattern in this discussion. In symmetrical triangles, support and resistance lines merge. Symmetrical triangle tops have prices that trend up to the formation, whereas bottoms have prices leading down. To cite Bulkowski and his findings again, premature breakouts occur about 71 percent to 76 percent of the way to the triangle apex. A downsloping trend line drawn along the tops connects minor highs, while an upsloping trend line supports the minor lows. In Bulkowski's test runs, there are twice as many triangles with upward breakouts as with downward ones.

The Deutsche Telekom stock chart (Figure 4.43) shows a symmetrical triangle.

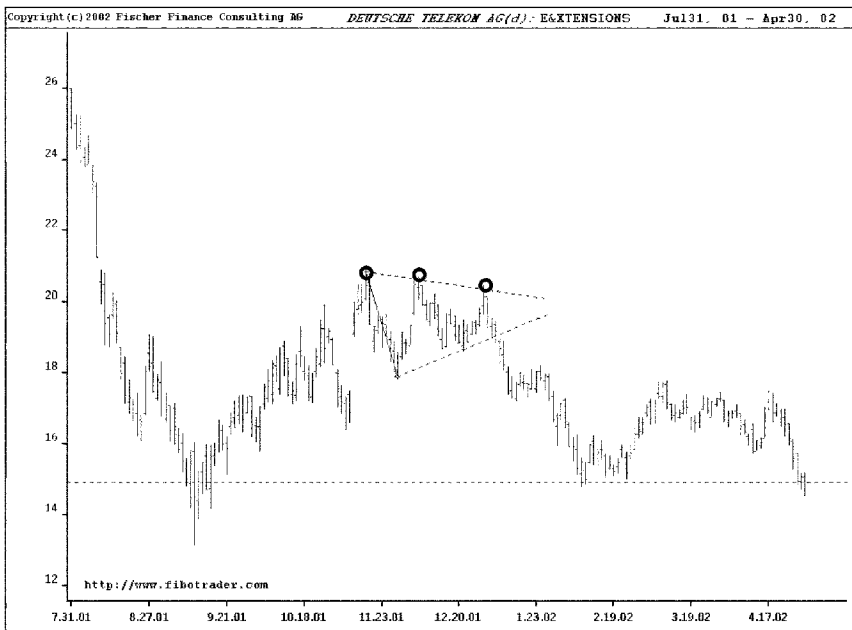

Figure 4.43 Deutsche Telekom chart from 07-01 to 04-02. Symmetrical triangle.

With this entry rule, we always wait for a breakout of the market. We check the price pattern for at least three peaks or valleys



touched by the support or resistance line. The breakout has to occur right through either the support or the resistance line.

If we see a breakout to the downside (short entry), we place the stop-loss at the triangle high. If we see a breakout to the upside, we place the stop-loss at the triangle low.

Doubling the distance from highest high to lowest low of the symmetrical triangle once more facilitates the profit target rule. For the relevance of profit targets (on a rule that is similar to the one used here), Bulkowski reports a rate of 62 percent realized profit targets on downside breakouts and 81 percent realized profit targets on breakouts to the upside.

Finally, for trailing stops, we buy flat at the most recent peak in a profit (short positions) or sell flat at the most recent valley in a profit (long positions).

Descending triangles—in contrast to symmetrical triangles—have a horizontal trend (or support) line and a downsloping resistance line. Ascending triangles have a horizontal resistance line and an upsloping trend (or support) line.

Triangles of the ascending or descending kind are easy to identify. Following Bulkowski, we find far fewer descending triangles than ascending ones. Almost two out of three (422 out of 689) triangles that Bulkowski identified were consolidations of the current trend. This means that if the price trend is downward going into the triangle, it is still moving downward after leaving it. Furthermore, almost three out of four ascending triangles show a meaningful rise after an upside breakout. Again, we call this sort of 3-point chart pattern a “continuation pattern.”

Breakouts of the support or the resistance line forming the triangle are indications of valid market entries. In all cases, we wait for the occurrence of at least three peaks on the resistance line or three valleys on the support line.

The stop-loss point is marked by the support line on buy signals and by the resistance line on sell signals. As a rule of thumb, the line opposite to the direction of the market entry always marks the relevant stop-loss point.

Profit target rules and trailing stop rules are similar to the ones for symmetrical triangles. For the profitability of profit targets, Bulkowski reports 89 percent of ascending and 67 percent of descending triangles meet precalculated price targets.



The chart of the German major bank Commerzbank in Figure 4.44 shows the pattern of a descending triangle.

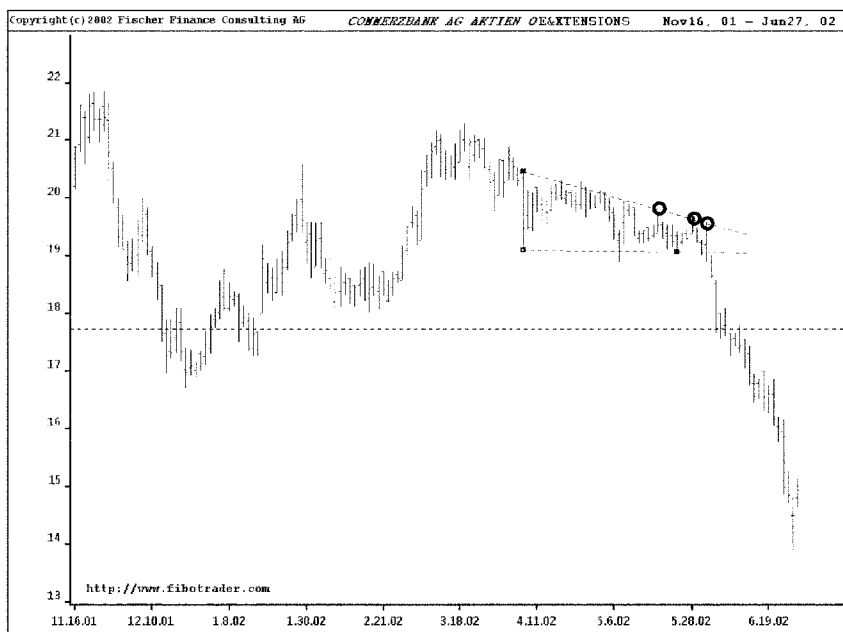

Figure 4.44 Commerzbank chart from 11-01 to 06-02. Descending triangle.

Summary

By design, 3-point chart patterns are useful for determining trend reversals. However, 3-point chart patterns of the continuation type also can provide valuable information.

Chart patterns are among the most important investment tools available. They express investor behavior and provide a rare consistent element in the analysis of structures in price data.

Valid chart patterns do not occur too often, and traders have to look for them. It takes great patience to work with 3-point chart patterns. On the other hand, traders have to act instantly on most breakouts, and executing trades based on 3-point chart patterns requires considerable experience.



A few results of empirical research may be helpful in understanding chart patterns. We are grateful for the efforts of Thomas Bulkowski in sorting chart patterns according to statistical criteria. Readers of his works will find a statistics summary that includes performance statistics for all of the chart patterns discussed in his encyclopedia (Bulkowski, pp. 654–657). In the following paragraphs, we refer to the findings of Bulkowski for the 3-point chart patterns we have tackled (and some of the candlestick patterns discussed earlier).

Before showing the statistics in tabular form, we need to state Bulkowski's criteria.

Bulkowski defines a *failure rate*, which is the percentage of formations that do not work as expected, including 5 percent failures. The numbers apply to formations once they stage a breakout (confirming the formation).

Bulkowski also distinguishes between reversal or consolidation. The letter "R" appears if the majority of formations act as reversals of the price trend, and the letter "C" appears for consolidations (or continuations, as we call them). If both R and C appear in an entry, then the chart pattern has no overriding majority of either type.

Furthermore, Bulkowski separates *throwbacks* from *pullbacks*. A throwback is an upside breakout that returns prices to the top of the formation or trend line boundary. A pullback is a downside breakout that returns prices to the bottom of the formation or trend line boundary. Both occur after a breakout and return within 30 days. The percentages for throwbacks apply to formations with upside breakouts only; pullback percentages apply to downside breakouts only.

In addition, Bulkowski provides a measure for *average rise or decline*. He typically measures the average rise or decline from the price on the breakout day (using the daily high or low) that is closest to the formation. The ultimate high or low is the highest or lowest point before a significant change in trend (typically a 20 percent price change, which is measured high to low).

From these figures, Bulkowski computes a value for *likely rise or decline* and tabulates a frequency distribution of the results. The most likely rise or decline is the range with the highest frequency and usually excludes the rightmost column.

Most important to our readership is Bulkowski's *rank by score*. He separates the table entries into bullish (1 to 35) and bearish (1 to 32) formations and then ranks them by their score. The score is the average rise or decline times the most likely rise or decline divided by



the failure rate. The best rank is 1. Bulkowski used bull market data for the five years beginning in mid 1991.

Table 4.11 lists the relevant (in the context of this book) 3-point chart patterns—and related candlestick patterns—in alphabetical order.

Table 4.11 Summary of Statistics for 3-Point Chart Patterns (and Candlestick Patterns)

Formation	Failure Rate (%)	Rev. and/or Cont.	Rank by Score
Broadening wedge, ascending	6	R	13
Broadening wedge, descending, down	41	R	25
Broadening wedge, descending, up	41	R	25
Double bottom	3	R	4
Double top	17	R	21
Hanging man, down breakout	22	C	27
Hanging man, up breakout	67	R	33
Head & shoulder, bottom	5	R	9
Head & shoulder, top	7	R	11
Key-reversal day, bottom	17	R	29
Key-reversal day, top	24	R	26
Rectangle bottom, down breakout	4	C	8
Rectangle bottom, up breakout	0	R	32
Rectangle top, down breakout	0	R	31
Rectangle top, up breakout	2	C	1
Triangle, ascending	2	C	3
Triangle, descending	4	C	6
Triangle, symmetrical, bottom, down	2	C	2
Triangle, symmetrical, bottom, up	3	R	5
Triangle, symmetrical, top, down	6	R	10
Triangle, symmetrical, top, up	5	C	11

Source: Trading Classic Chart Patterns, by Thomas N. Bulkowski (New York: Wiley, 2002), pp. 655–657. Reprinted by permission of the author.

The table indicates that some of the chart patterns we have stressed do well and prove reliable in practical trading, at least according to Bulkowski's rank by score.

The greatest advantage of working with chart patterns is that skilled traders can execute them without elaborate computer programs. Although the 3-point chart patterns may look somewhat old-fashioned, they are powerful trading tools.



PHI-CHANNEL APPLICATIONS

Investors' behavior is expressed not only in chart patterns, trend formations, or sideways markets, but also in peaks and valleys. Every peak or valley is an indication of what the majority of investors expect at any moment in time. Intraday peaks or valleys, however, are not as meaningful as those on daily or weekly charts. Our analysis, therefore, focuses on daily data, but it may easily be extended to sets of weekly data.

Whenever traders are looking for a good entry point to buy long or sell short, they want to come as close as possible to important turning points in the market. If they stay close enough to the market action, the stop-loss level is not too far away from the entry point. On the other hand, the profit potential is big enough to participate in longer market trends.

Trading Rules

Significant peaks and valleys in the markets are much more relevant than often assumed. Trend channels are generated by establishing major peak-to-peak and valley-to-valley connections out of regular 3-wave or 5-wave market moves. This is why trend channels should be the primary step when analyzing markets.

PHI-channels are improvements over regular trend channels and are generated slightly differently. Our PHI-channel analysis works with baselines as connections of significant high-to-low and low-to-high formations (see Figure 3.34 for a recap).

PHI-channels can be drawn either from impulse waves or from corrective waves by determining the outside parallel line of a PHI-channel on the basis of the next significant peak or valley to the right of the baseline. As soon as a PHI-channel has been established, the width of the PHI-channel measured as the distance from baseline to parallel line can be multiplied by the ratios 0.618, 1.000, 1.618, 2.618, 4.236, and so on (as shown in Chapter 3, Figure 3.35).

Depending on whether the baseline of the PHI-channel is trend following (running from valley to peak) or countertrend (connecting peak with valley), it is possible to draw PHI-channel trend lines or PHI-channel resistance lines in various distances from the outside parallel line of the PHI-channel. Combinations of PHI-channel trend lines and PHI-channel resistance lines create a spiderweb



design for mapping market price action and predicting future market moves.

In a trending market with more than three waves upward or downward, the baseline is adjusted to the most recent high in an uptrend or the most recent low in a downtrend. The outside line has to be adjusted to the peak or valley on the right side.

Entry signals on PHI-channels are generated when the outside line of the PHI-channel and the most recent peak or valley are broken (Figure 4.45).

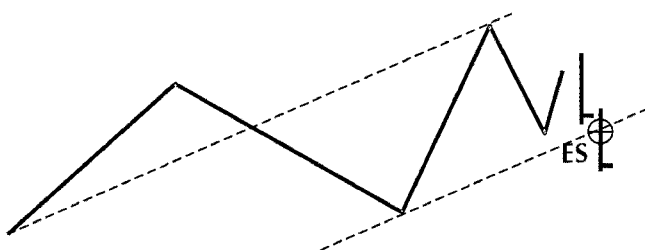

Figure 4.45 Entry rule to establish a short position.

This simple concept works well to define long or short market entries in many markets and products because the entry signals are generated after a failure in the price move.

The peak or the valley that turns out to be a failure can occur either before or after the outside line of the PHI-channel is broken. We receive a valid entry signal in both cases.

The stop-loss level, as discussed throughout this chapter, is the most recent peak or valley in a loss after the sell signal or buy signal has been generated. This rule is illustrated on a short position in Figure 4.46.

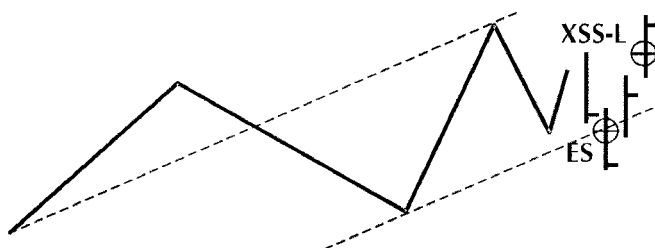

Figure 4.46 Stop-loss rule on a short position.

Once we are stopped out, we have to wait for a new entry point. Figure 4.47 illustrates how to reenter the market.

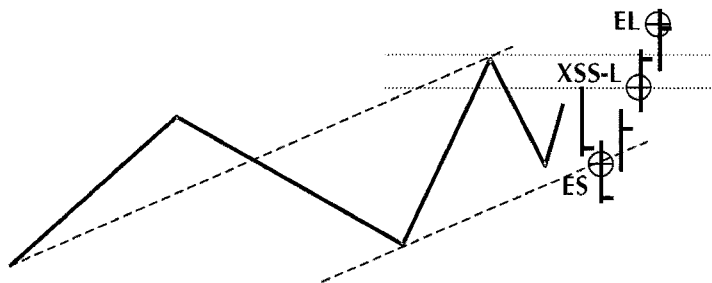

Figure 4.47 Reentry rule out of a flat position after a stop-loss.

Most signals are reversal signals. Once we get stopped out, we have to wait until the market moves out of the trading range. We buy or sell as soon as the closing price trades above (or below) the peak (or valley) that marks the upper (or lower) border of the trading range.

The trailing stop is again easy to explain and easy to understand. We work with the most recent peak (on short positions) or valley (on long positions) in a profit. After the trailing stop is triggered, we have to wait for a new PHI-channel and a failure to get an entry signal.

For a trading example that is a convincing application of the PHI-channel rules, we have chosen the S&P 500 Index over more than a year, between July 2001 and November 2002. Using just 16 months and only one product provides a limited sample for generalizations about the quality of the trading approach. However, the tested time frame contains uptrends, downtrends, and sideward markets; and, therefore, it clearly indicates the trading potential of the PHI-channel approach.

Trading Example

Trading PHI-channels is appealing because they always stay close to the market action. PHI-channels work best on volatile products such as stock index futures, financial futures, cash currencies, or volatile commodities. The approach is easy to follow, but traders must be disciplined to execute the trading signals.

Figure 4.48 shows 12 relevant trading signals in the S&P 500 Index for the period from July 2001 to November 2002.

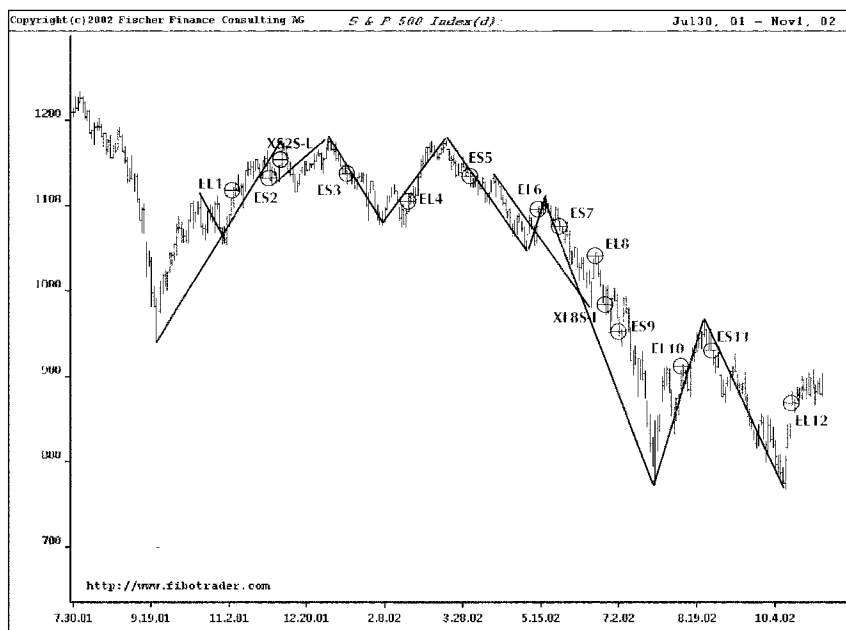

Figure 4.48 S&P 500 chart from 07–01 to 11–02. Simulation of trading signals based on PHI-channels daily (EL: entry long, ES: entry short, XL: exit long, XS: exit short, S-L: stop-loss).

When there is no peak or valley after the entry, we have to work with a big stop-loss, as seen after the long entry EL8 in Figure 4.48. On the other hand, big trend movements are caught as well. When using this trading approach, we recommend starting with only a moderate leverage.

The main reason we show a Fibonacci-related trading approach based on PHI-channels is that later in the book we work with a similar concept when dealing with PHI-ellipses.

To limit the number of lines in the chart in Figure 4.48, we show only the baselines of the PHI-channels for each 3-wave price move and omit the outside lines parallel to the respective baselines.

Table 4.12 summarizes the profits and losses on the sample trades.

Table 4.12 Trading Signals

#	Entry Rule	At	Exit Rule	At	Profit/ Loss in Points
1	Buy long	1,113.00	Sell reverse	1,131.00	18.00
2	Sell reverse	1,131.00	Stop-loss	1,145.00	(14.00)
3	Sell short	1,136.00	Buy reverse	1,101.00	35.00
4	Buy reverse	1,101.00	Sell reverse	1,133.00	32.00
5	Sell reverse	1,133.00	Buy reverse	1,089.00	44.00
6	Buy reverse	1,089.00	Sell reverse	1,076.00	(13.00)
7	Sell reverse	1,076.00	Buy reverse	1,040.00	36.00
8	Buy reverse	1,040.00	Stop-loss	980.00	(60.00)
9	Sell short	975.00	Buy reverse	912.00	63.00
10	Buy reverse	912.00	Sell reverse	931.00	19.00
11	Sell reverse	931.00	Buy reverse	866.00	65.00
12	Buy reverse	866.00			Open

PHI-channels can serve as trend lines and resistance lines depending on whether we work with peak-to-valley formations (counter-trend lines) or valley-to-peak formations (trend lines) in an uptrend (vice versa in a downtrend). The S&P 500 Index chart is an example of perfect symmetry in market action, which can only be captured by working with the Fibonacci summation series and the ratios from the PHI series. In Chapter 5, we present more Fibonacci-based market symmetry in the discussion of PHI-ellipses as Fibonacci trading tools.

Summary

Since this book is purely educational, we limit the analysis to one product and do not use time frames beyond the years 2001—2002. The results are convincing and leave plenty of room for creative readers to fine-tune and to cross-examine our example for alternative, and perhaps even more productive, PHI-channels.

Once PHI-channel trend lines and PHI-channel resistance lines are triggered, they are indicators of forthcoming market action. They do not have immediate forecasting value, but they can be important support or resistance levels for market trends. The S&P 500 Index



demonstrated that PHI-channel lines drawn weeks or months ahead do not lose any degree of quality. The biggest limitation of PHI-channels lies in the ratios of the PHI series, which quickly get too big to create meaningful PHI-channel lines for the future. To solve this problem and to stay close to the markets, we have to work with every significant peak or valley in sequence.

Newcomers to *Fibonacci* tools and graphic means of market analysis often find it difficult to correctly detect PHI-channel baselines and the peaks and valleys through which to draw the outside parallel lines. Almost all traders, at first, make the mistake of overlooking the most significant peaks or valleys and, instead, choose smaller ones that bring PHI-channel lines closer to the markets.

How can traders distinguish correct PHI-channels from false ones? A correct PHI-channel is identified by looking at whether the first major turning point in the market after the PHI-channel is drawn finds its support or resistance in the first PHI-channel trend line or resistance line drawn at a ratio 0.618 or 1.000 (at most). Once this condition is met, we can be sure that the following PHI-channel lines drawn at higher ratios from the PHI series will be important support or resistance lines as well.

PHI-channel lines can be drawn exclusively with the WINPHI software. Readers should check the User Manual for instructions on quickly and easily getting to PHI-channel trend lines and PHI-channel resistance lines. The example in this chapter and additional sets of sample market data are included in the WINPHI program.

PHI-channel lines are terrific tools to map out price action and to make investor behavior visible. Market swings can be followed up and down like a road map, as long as traders select the correct PHI-channel lines. Our findings are a strong indication that market price action is not random, but symmetrical. Just as Elliott realized, market price movements are like the tide, smoothly swinging forward and back again.





abcBourse.ir



@abcBourse_ir

مرجع آموزش بورس



بازنشر :

5

PHI-ELLIPSES

Because swing formations are easy to identify and integrate into computerized trading environments, traders or managers investing with smaller accounts often use peak and valley formations. Many profitable trades are possible as long as there are regular wave patterns and each impulse wave defines new highs or new lows by a wide margin. In multiple corrections with many false breakouts, swing systems are of little use since they are based solely on price analysis.

When we add the time element to the market analysis, it filters noise out of the market moves and brings more stability into investment strategies. This is where PHI-ellipses come in.

Working with PHI-ellipses is not easy. Their basic structure is simple; but because price patterns may change over time, the final shape of a PHI-ellipse that circumvents a price pattern may also vary.

Initially, the application of PHI-ellipses may seem confusing because there are different forms and wave structures within a PHI-ellipse. In addition, PHI-ellipses can sometimes be linked together. Both skill and imagination are necessary to use PHI-ellipses as investment tools.



To deal with this complexity, we first describe the basic features and parameters of PHI-ellipses in detail. We then present examples that illustrate how to apply PHI-ellipses as Fibonacci devices to real-time trading.

BASIC FEATURES AND PARAMETERS OF PHI-ELLIPSES

The PHI-ellipse is a unique Fibonacci trading tool that can only be drawn by a computer.

As mentioned in Chapter 3, PHI-ellipses identify underlying structures of price moves and circumvent price patterns. When a price pattern changes, the shape of the PHI-ellipse circumventing the respective market price pattern changes, too. Nearly all market price moves follow the pattern of a PHI-ellipse.

PHI-ellipses are related to the Fibonacci ratio PHI in a similar way as the Fibonacci summation series, as well as corrections and extensions (see Chapter 4).

Generally speaking, the ratio of major axis a to minor axis b defines the shape of an ellipse. Ellipses are turned into PHI-ellipses in all cases where the ratio of major axis to minor axis $e_x = (a \div b)$ is a member number of the PHI series.

To make PHI-ellipses work as tools for chart analysis, we have applied a (proprietary) transformation to the mathematical formula that describes the shape of the ellipse. We still consider the ratio of major axis a to minor axis b of the ellipse, but in a Fischer-transformed way, in mathematical terms $e_x = (a \div b)^*$.

We introduce PHI-ellipses as instruments for investments countertrending to market action. We observe whether a price move stays within a PHI-ellipse and invest accordingly if a price move breaks out of a PHI-ellipse at the very end.

Historical charts show that almost all price moves in commodities, futures, stock index futures, or stocks can be circumvented with a PHI-ellipse. However, finding the correct PHI-ellipse is an art. It takes skill, experience, patience, and trust in the analysis to effectively use PHI-ellipses as Fibonacci investment tools.

It is impossible to forecast the final shape of a PHI-ellipse at the beginning of a price move. As we later prove on various examples,



PHI-ellipses may follow one after the other symmetrically. Small PHI-ellipses may be followed by long PHI-ellipses, or PHI-ellipses may be connected with each other, and so on. The challenge is to correctly interpret price moves and select PHI-ellipses accordingly. Once investors learn how to identify the appropriate market pattern, working with PHI-ellipses becomes easier.

The remainder of this section is divided into two parts. We first examine the shape and the slope of PHI-ellipses, and include approaches for attaching and overlapping PHI-ellipses. In the second part, we address entry and exit rules for the generation of trading strategies from PHI-ellipses.

Typical Features of PHI-Ellipses

Dealing with chart patterns depends a lot on the definition of swings just as it depends on controlling impulse waves and corrections without losing sight of the main trend picture.

The strength of PHI-ellipses, in this respect, is that no matter how many waves or subwaves are in a price pattern, we receive a solid overall picture of the total price pattern as long as a PHI-ellipse can circumvent it.

Even if we reduce the analysis to a simple 3-swing pattern, an indefinite number of combinations of impulse waves and corrections will be possible. Impulse waves are fairly simple to handle, whereas dealing with corrections and long sideward periods in the markets can be very tricky. Traders and analysts call these periods “noise” in the markets.

PHI-ellipses are ideal geometrical trading tools for coping with noise and analyzing price moves over time without having to focus too much on every intermediate minor peak or valley between the starting point and the ending point of the price pattern.

The best way to demonstrate the generation of PHI-ellipses is by starting with a circle and then turning the circle into PHI-ellipses. A circle is a special kind of PHI-ellipse because the ratio of the major and minor axes is 1.000 from the PHI series.

Figure 5.1 shows the process of generating PHI-ellipses.

From the circle, ongoing PHI-ellipses can be drawn at alternative axis ratios 1.618, 2.618, 4.236, 6.854, 11.090, 17.944, 29.034, and so on, from the PHI series. According to the mathematical formula



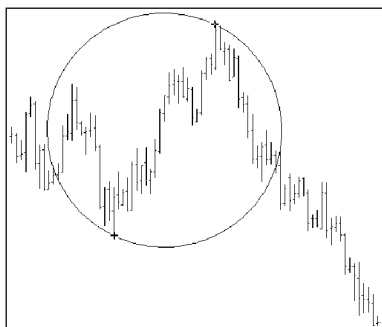

(a)

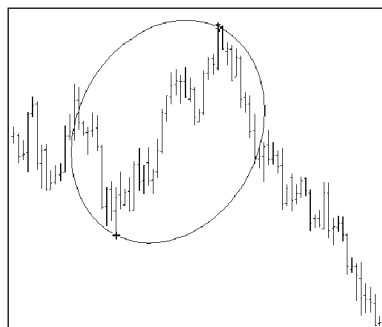

(b)

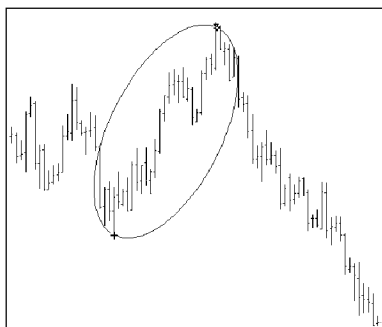

(c)



(d)



(e)

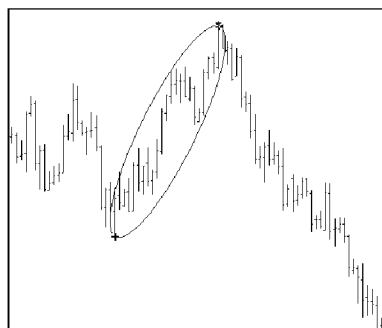

(f)

Figure 5.1 Generation of PHI-ellipses using different ratios from the PHI series. From top left to bottom right: ratio 1,000 (circle); ratio 1.618; ratio 4.236; ratio 6.854; ratio 11.090; ratio 17.944.

for Fischer-transformed PHI-ellipses, the length of the major axis remains unchanged. The minor axis thereby gets shorter and shorter. The resulting PHI-ellipses become narrower and narrower and finally perfectly enclose the entire price move.

It is evident from the sample charts that because ellipses have such special structures, they can only be used on computers and with particular software packages. Fischer-transformed PHI-ellipses, moreover, are unavailable elsewhere and can only be generated by running the WINPHI graphics software that accompanies this book.

PHI-ellipses are interesting graphical trading tools because their very structure is founded on a 3-wave pattern, as shown in Figure 5.2.

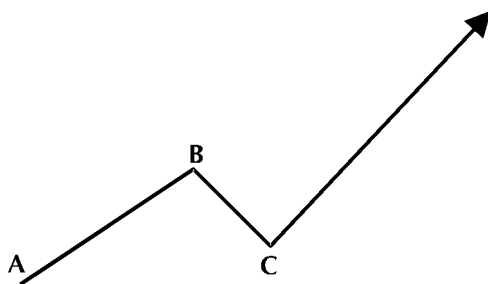

Figure 5.2 General structure of a 3-wave pattern.

Once we have identified the three points A, B, and C in the idealized 3-wave swing, we can position the PHI-ellipse around these three points. Wave 1 from A to B is an impulse wave. Wave 2 from B to C is the corrective wave to the impulse wave. For wave 3, we expect a second impulse wave in the direction of the first impulse wave.

The fundamental structure of the PHI-ellipse provides another way to analyze price moves. Because it is dynamic over time and follows price patterns as they develop, we must be patient and wait—from the very beginning to the very end—until a price move stays within the PHI-ellipse. As soon as the market price moves out of the

PHI-ellipse, action is possible, but only if a price pattern runs completely inside a PHI-ellipse until reaching the final point.

As a general rule, if the angle of a PHI-ellipse is sloping upward, we can sell at the end of the PHI-ellipse. If the slope of the PHI-ellipse is downward, we can buy at the end of the PHI-ellipse. The exceptions to this rule are described later.

It is important to remember that PHI-ellipses are not means of forecasting market moves. We will never know in advance whether a price move will stay within the PHI-ellipse and reach its end so that we can take action. We must always wait to see if a price move stays inside the borders of the PHI-ellipse, and we cannot take action unless the move meets the final point of the PHI-ellipse. The rationale behind this waiting principle becomes clear in the examples later in this chapter.

Working with PHI-ellipses means watching price action as it progresses. Price action starts with the impulse wave 1 from A to B in Figure 5.2, followed by the correction from B to C. In the discussion of corrections and extensions in Chapter 4, Elliott's wave principles helped us determine that the corrective move is not expected to go lower than the low at the beginning of wave 1. Only in exceptional cases did we consider bull traps and bear traps. With PHI-ellipses, however, we consider all sorts of 3-wave moves as long as we can put a PHI-ellipse around them (see Figure 5.3).

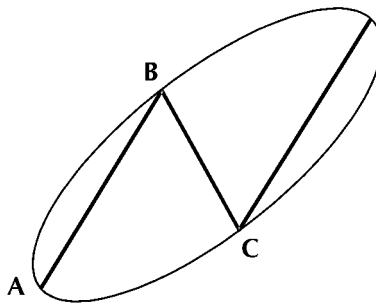

Figure 5.3 PHI-ellipse circumventing a 3-wave price pattern.

The 3-swing pattern in Figure 5.3 is an ideal picture of a price move, but in reality, waves within a PHI-ellipse may take many forms

and magnitudes. As price action progresses, peaks and valleys may touch the outside of a PHI-ellipse several times without destroying the pattern.

We have analyzed and worked with PHI-ellipses for many years, and have found it fascinating to observe the different kinds of price action within PHI-ellipses. Based on the developing price action, PHI-ellipses might need adjustment, which is why working with them takes such discipline. But once investors get used to them, they realize that PHI-ellipses are amazing Fibonacci-related trading tools.

There are many possible price behaviors within PHI-ellipses. According to the appropriate ratio for drawing a PHI-ellipse chosen from the PHI series (see Figure 5.1), PHI-ellipses may be fatter or thinner, longer or shorter. But these facts do not have to worry investors too much, because price action itself shows up before the final structure of the PHI-ellipse. Investors must have tremendous patience and flexibility to wait until market pricing reaches the end of the PHI-ellipse. However, the dynamism and flexibility of PHI-ellipses can also be an investor's strength, because no other investment tool can make price patterns as graphically visible.

There is no guarantee, only a high probability, that the end of a PHI-ellipse will ever be reached. If the final point of a PHI-ellipse is not reached and market pricing leaves the borders of the PHI-ellipse prior to the end, then we have to reevaluate price action and start looking for the next PHI-ellipse that unfolds.

Figure 5.4 shows two typical price movements that do not reach the final points of the PHI-ellipses.

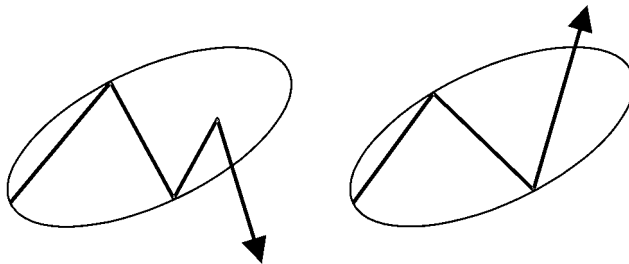

Figure 5.4 Price movements not reaching the final points of PHI-ellipses.

We cannot define a standard PHI-ellipse that suits every product. To work properly with PHI-ellipses as investment tools, we must identify the minimum length and the minimum thickness of relevant PHI-ellipses for every product that we trade. Each product reveals its characteristic price behavior in typical price patterns that we can identify only with historical charts.

The attached WINPHI software package is designed to backtest Fibonacci tools on historical data. It would not be enough to analyze any kind of historical data. It is important to analyze all of the historical data with the same price scale.

A PHI-ellipse specific for a certain product can be identified only when the price scale over the test period remains the same. This identification routine has to be done by hand with the aid of computer-graphics capabilities.

Once the length and thickness of a typical PHI-ellipse for any given product are identified over 10 years or more with a constant price scale, the probability is high that investors can use this PHI-ellipse for future trading.

PHI-ellipses tell us where we are in the market price action at any point in time. Whenever a market trend reverses at the end of a PHI-ellipse, we can take the final point of an old PHI-ellipse as the beginning of a new one (see Figure 5.5).

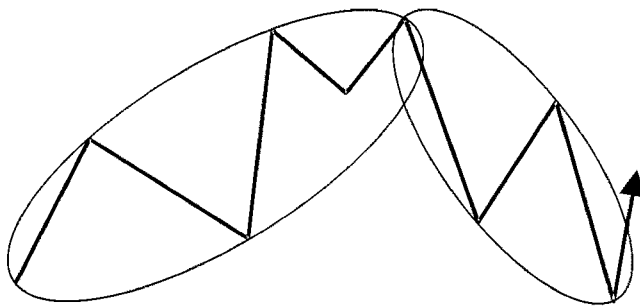

Figure 5.5 Attaching PHI-ellipses.

New PHI-ellipses often start to develop as soon as price patterns reach the end of old PHI-ellipses. This occurs especially when PHI-ellipses have a steep upward or downward angle. Since PHI-ellipses

work best as countertrend investment tools, sideward markets provide the most favorable price patterns.

Whenever market price action moves out of a PHI-ellipse before reaching the final point of the PHI-ellipse, either to the upside or to the downside, we can assume a new market price pattern is beginning that might fit into a new PHI-ellipse. In addition to attaching PHI-ellipses, we may also find overlapping PHI-ellipses as shown in Figure 5.6.

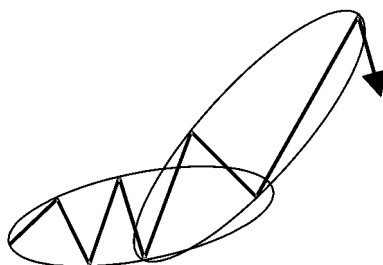

Figure 5.6 Overlapping PHI-ellipses.

The slope of a PHI-ellipse is another parameter that traders must not underestimate. This slope determines the profit potential of countertrend trading signals from market entry point to profit target (see Figure 5.7).

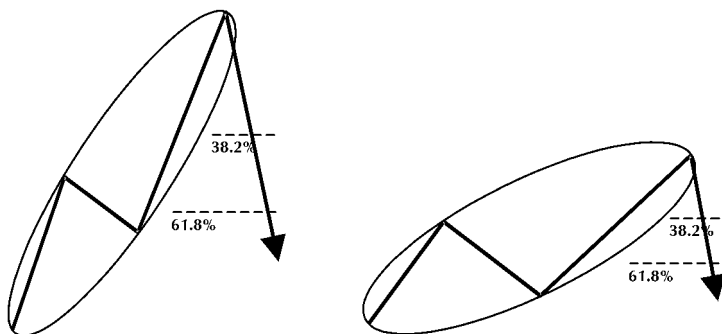

Figure 5.7 Profit potential based on the slope of PHI-ellipses.

The slope of a PHI-ellipse often is small, as can be expected in sideways markets. In these cases, the beginning of a new PHI-ellipse and the end of an old PHI-ellipse are likely to overlap, as can be seen in Figure 5.6.

Monitoring the slope of a PHI-ellipse is important. Like the countertrend moves at the end of extensions (see Chapter 4), retracements of 38.2 percent or 61.8 percent at the points of major trend changes in the markets should go back in the direction of the initial impulse wave. The steeper a PHI-ellipse develops, the larger the distance becomes from wave 1 to the final point of the PHI-ellipse. The greater the distance becomes from wave 1 to the final point of the PHI-ellipse, the larger the profit potential in points on 38.2 percent or 61.8 percent retracements to this distance.

In addition to circumventing chart patterns in an actual or short-term trend, PHI-ellipses may also circumvent the bigger picture from a long-term perspective. This might include a couple of smaller trend changes (see Figure 5.8).

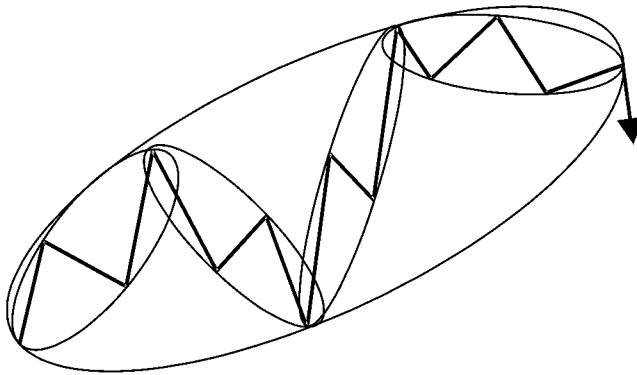

Figure 5.8 Long-term PHI-ellipse circumventing short-term PHI-ellipses.

Investors who use PHI-ellipses must monitor price moves consistently. This is a minor problem on weekly and daily data, but on intraday data, there is a lot of pressure to identify and to wait for the end of a PHI-ellipse. Therefore, PHI-ellipses on an intraday basis have to be handled with care and can only be recommended for experienced Fibonacci traders.

Simultaneously analyzing the same product on weekly and on daily data often benefits the outcome of the analysis. For example, recognizing a PHI-ellipse with a strong uptrend from weekly data will help to identify the correct trading signals in daily data. Figure 5.9 illustrates the latter notion.

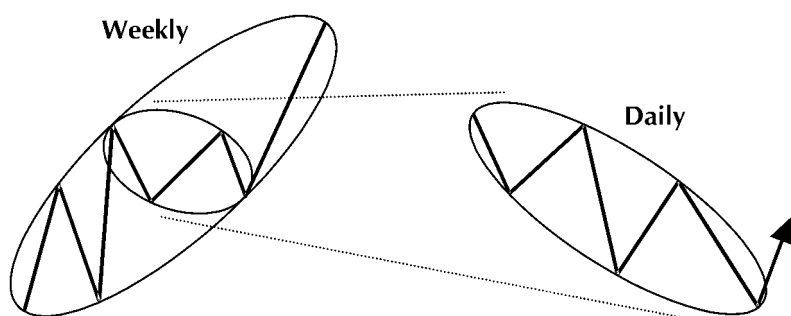

Figure 5.9 Simultaneous analysis on weekly and daily PHI-ellipses.

To identify the best average PHI-ellipse for any given product requires a software package like our WINPHI program, which allows investors to draw any PHI-ellipse desired on sets of historical data and on a constant price scale.

Once traders have identified the PHI-ellipse for any particular product, they can apply it to real-time trading. Identifying specific PHI-ellipses is like pattern recognition in the markets. Pattern recognition has an advantage, however, because stable price patterns detected on historical price moves have a chance of repeating and can become trading indicators for the future.

Entry Rules and Exit Rules

The basic strategy for trading the markets using PHI-ellipses is, first, to wait for a price move to develop inside the borders of a PHI-ellipse; and, second, to act counter to the main trend direction as soon as the end of the PHI-ellipse has been reached and market pricing leaves the PHI-ellipse.

Catching the rhythm of market moves by attaching PHI-ellipses and adding countertrend trades to each other is illustrated in Figure 5.10.

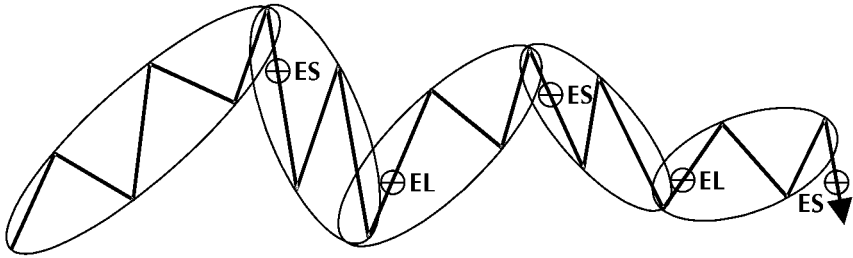

Figure 5.10 Basic scheme of investment by using PHI-ellipses.

We recommend selling at the end of a PHI-ellipse when it has an upward slope and buying at the end of a PHI-ellipse when it has a downward slope.

An entry rule confirms trend reversals to the upside or to the downside at the end of a PHI-ellipse. The rule is set to the lowest low of the previous one, two, three, or four days for sell signals, and the highest high of the previous one, two, three, or four days for buy signals (see Figure 5.11). The choice of entry rule depends on the investor's risk preference and time frame for entry.

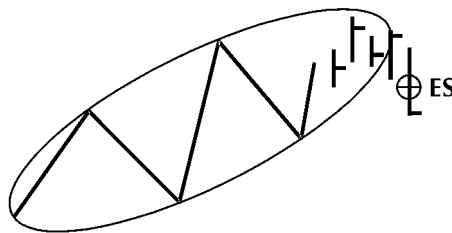

Figure 5.11 4-day lowest low entry rule.

As soon as we are invested on a short position, we define a stop or a stop-reverse point at the highest high of a price bar within the previous PHI-ellipse. If we are invested long, we protect our position

with a stop-loss set to the lowest low of a price bar within the previous PHI-ellipse.

Figure 5.12 illustrates a stop-loss protection on a short position.

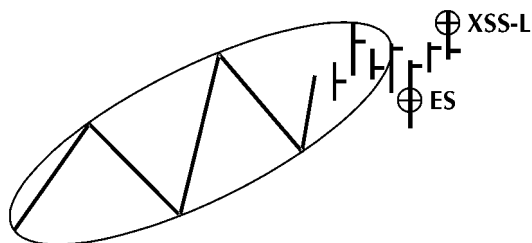

Figure 5.12 Stop-loss protection on a short position.

For an alternative entry point, we may consider the trend channel that touches the relevant PHI-ellipse on either side (see Figure 5.13).

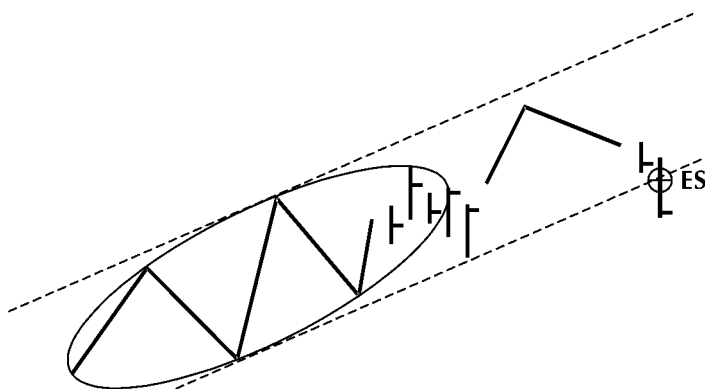

Figure 5.13 Short entry on a combination of PHI-ellipse and trend channel.

By choosing the conservative option of a double confirmation by PHI-ellipse and trend channel, we accept that we may sacrifice some of the profit potential that could have been realized with a more sensitive entry rule. On the other hand, we may avoid a number of losing trades in strong trending market conditions by staying in the trend channel as long as it lasts.

If the market price leaves the PHI-ellipse at the very end and immediately rises to new highs, we get a buy signal at the level of the highest high made within the PHI-ellipse. Figure 5.14 illustrates our strategy for dealing with runaway markets. For sell signals, the correct entry point runs vice versa.

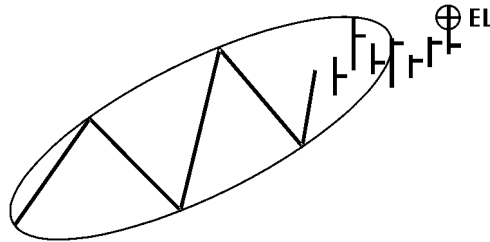

Figure 5.14 Long entry on a runaway market.

The stop-loss or stop-reverse level on this buy signal is set to the lowest low of the previous three days, starting on the day when the market price reached the end of the PHI-ellipse (see Figure 5.15). On sell signals on runaway markets, the stop-loss or stop-reverse level is the opposite; it is set to the highest high of the last three trading days inside the PHI-ellipse.

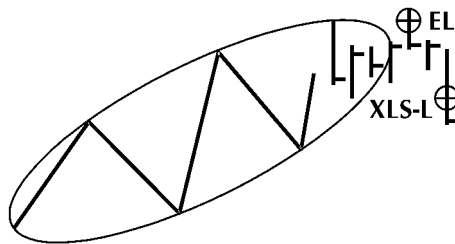

Figure 5.15 Stop protection on runaway long entry.

If a market position is established and the market price moves in the anticipated direction, the investor must decide when to take profits. Several options are available to the investor: trailing stop exits, profit target exits, exits on extensions, time exits based on the Fibonacci summation series, and exits on the end of a PHI-ellipse.

The most conservative strategy is to work with a trailing stop set to the high of the previous four days on sells (vice versa on buy signals). In most cases, this option protects at least part of the profits, but it also means giving away open profits already accumulated (see Figure 5.16).

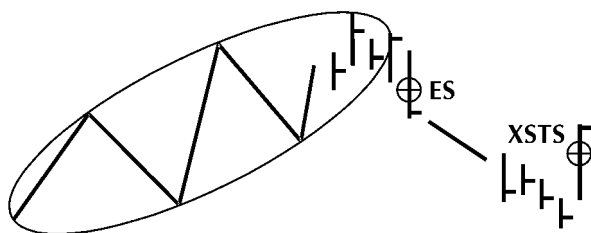

Figure 5.16 Trailing stop exit on previous 4-day high breakout.

If we do not want to give up any of our accumulated profits, we can take the risk that the market might move in the direction of our signal after we get stopped out in a profit. In this case, we should pre-define a fixed profit target level to cover a position.

We select profit target levels that can be derived from the PHI series (introduced in Chapter 4). The levels we work with are 38.2 percent, 50.0 percent, and 61.8 percent of the total preceding market move, which is the distance from bottom to top of the PHI-ellipse that generated our entry (see Figure 5.17).

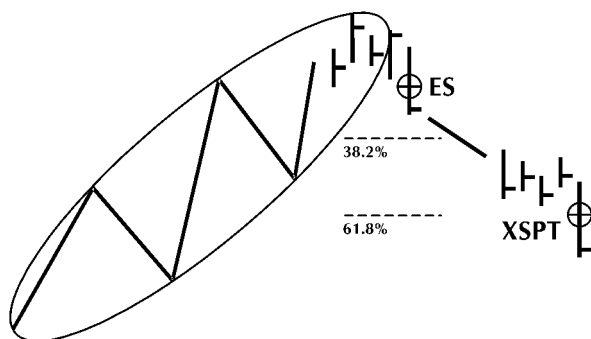

Figure 5.17 Profit target levels at 38.2 percent and 61.8 percent.

The profit target level that an investor favors depends not only on the risk preference of the investor, but also on the amplitude of the preceding PHI-ellipse.

If the initial move inside the PHI-ellipse is smaller than a sample 200 ticks in the Japanese Yen cash currency (e.g., from 110.00 to 112.00), a larger profit target level of 61.8 percent is preferable; otherwise, the profit potential is too small. On the other hand, if the total amplitude of the underlying move is 10 full points (e.g., from 110.00 to 120.00) in the Japanese Yen cash currency, a profit target level of 38.2 percent might be good enough for an investor to minimize risk.

In addition to trailing stop exits and profit target exits, we can wait for a 3-wave swing in the direction of our signal and an extension out of this 3-wave swing.

As explained in Chapter 4, we precalculate the size of an extension by multiplying the amplitude of wave 1 by the Fibonacci ratio 1.618. We liquidate a position as soon as the profit target level in the direction of our signal has been reached at 1.618 times the amplitude of wave 1 (see Figure 5.18).

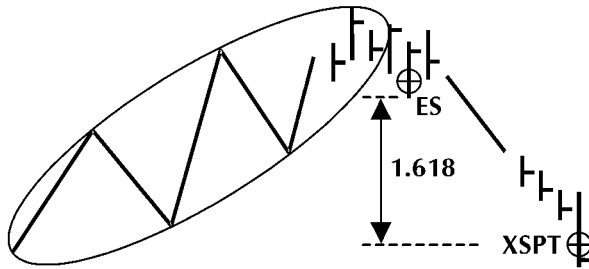

Figure 5.18 Profit target exit on an extension out of a 3-wave move.

Price targets are a solid way of exiting positions, but we can also define targets in time to protect accumulated gains.

To establish the average standard length of PHI-ellipses on any product based on numbers of the Fibonacci summation series, we can use historical data, along with a constant scale supplied by the WINPHI software and conduct test runs. If we then find out, for a certain product, that the average length of PHI-ellipses is 21 days, we can exit positions that have not been stopped out after 21 days (given that they

trade in a profit). The total move in the direction of our signal might continue, but we are content with the profit that we have realized with the Fibonacci count. Two additional conditions are that there has to be at least one 3-wave move within the 21 days and that the price move must stay within the shape of a PHI-ellipse (see Figure 5.19).

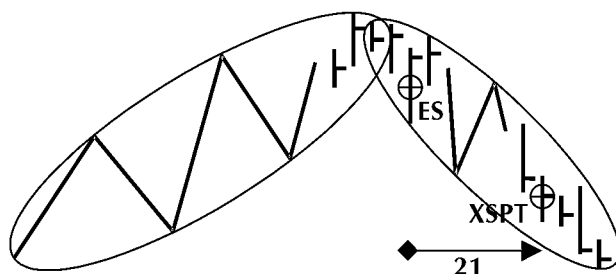

Figure 5.19 Profit target exit on a Fibonacci count of 21 days.

If the price move on our established position follows the shape of a PHI-ellipse, a fifth exit rule must be considered. We can wait until the market price reaches the end of the new PHI-ellipse and exit the position at the end of the PHI-ellipse. This exit rule requires the most patience and the strongest discipline, but it has the biggest profit potential of all five exit rules in our analysis of PHI-ellipses.

Figure 5.20 illustrates how to exit a position on the end of a PHI-ellipse.

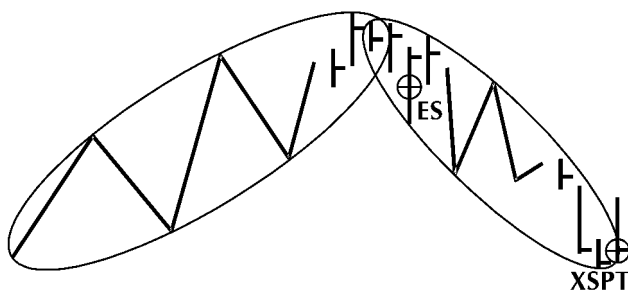

Figure 5.20 Profit target exit on the final point of a PHI-ellipse.

Attaching PHI-ellipses, as explained in the final exit rule, is the perfect approach for catching the rhythm of markets, but of course, market rhythms are not always ideal and perfect.

The following section explains how to work with PHI-ellipses as geometrical Fibonacci trading tools.

WORKING WITH PHI-ELLIPSES ON DAILY DATA

Working with PHI-ellipses is easy if we understand the rationale behind them. PHI-ellipses develop over time. The magic of PHI-ellipses is that the perfect form exists inherently from the beginning; but as users and investors, we only recognize the PHI-ellipses at their very end. Although all PHI-ellipses share a common key structure, their final forms vary, becoming thick or thin, long or short. They are individual manifestations of smaller trend moves or part of the bigger picture of a circumventing major trend.

The high in downtrends and the low in uptrends of the correction wave 2 in our wave count determine the slope of a PHI-ellipse. Because we always need three points to draw the first picture of a PHI-ellipse, we then have two possibilities. In the first case, the low of the correction in wave 2 in an uptrend is above the bottom of wave 1 (vice versa for highs instead of lows in downtrends). Depending on whether we have a 38.2 percent, 50.0 percent, or 61.8 percent correction, the slope of a PHI-ellipse will be bigger or smaller (see Figure 5.21).

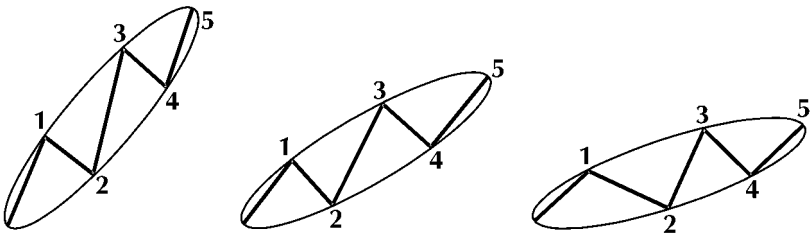

Figure 5.21 Slope of PHI-ellipses upward in relation to correction levels.

The second possibility is that the correction wave 2 goes below (or above) the starting point of wave 1 in an uptrend (or downtrend). In this case, the slope of a PHI-ellipse could turn out very small. As shown in Figure 5.22, a small PHI-ellipse slope indicates a sideward market.

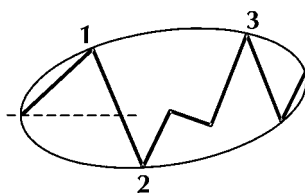

Figure 5.22 Slope of a PHI-ellipse as an indicator of a sideward market.

PHI-ellipses work on monthly, weekly, and daily charts; and those are the data compression rates on which we have conducted our analysis. When it comes to intraday charts, PHI-ellipses will also work on hourly charts. However, to avoid complicating the analysis at this point, we defer the description of intraday samples until later in this chapter.

The length of the correction in wave 2 after the first impulse wave often determines the length of a PHI-ellipse. We cannot know in advance how long the formation of wave 2 will last, however, so we do not recommend trading if the formation of a PHI-ellipse is in progress.

Wave 3, as the second impulse wave in our count, must be at least as long as the first impulse wave. Therefore, we have to adjust the width of PHI-ellipses on multiple sideward patterns (see Figure 5.23).

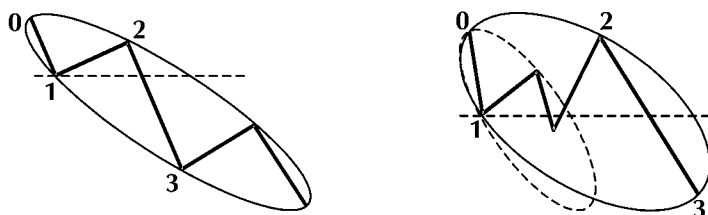

Figure 5.23 Adjustment of PHI-ellipses based on the duration of corrections.

We now focus our analysis on sets of daily charts of the Japanese Yen cash currency and the S&P 500 Index. As mentioned, we have selected these products for their public interest, volatility, and liquidity; and because they especially represent investors' behavior, which is the underlying maxim of Fibonacci analysis. In principle, of course, PHI-ellipses can be applied to every product traded.

We rely on only an 8-month time span for each of the two products, and during that time not one PHI-ellipse is like the other. This is similar to the work we have done with extensions and corrections. Even though we apply the ratio 1.618 to different price moves, the size of every price move results in the precalculation of different price targets. The same result occurs when we work with PHI-ellipses. We do not analyze a single swing pattern, but rather, a complete set of swings—smaller ones and bigger ones. Therefore, a major PHI-ellipse will circumvent the complete (and much bigger) price pattern with sometimes many or sometimes very few smaller price patterns in between.

PHI-ellipses have their roots in the Fibonacci ratio PHI and the ratios from the PHI series. We can combine PHI-ellipses with other Fibonacci tools, such as the Fibonacci summation series, extensions, and corrections. Doing so gives us an early indication where a PHI-ellipse might end. Because PHI-ellipses develop over time, the combination of Fibonacci tools is helpful to confirm multiple PHI-ellipses in progress. Based on the knowledge we accumulated from the analysis of extensions using the Fibonacci ratio 1.618, we can precalculate a price target from the amplitude of the first impulse wave inside the PHI-ellipse. Independent of any future market move patterns, we can then assume that if the market price ever reaches the precalculated price target, it might also mean the end of the progressing PHI-ellipse in price and time.

PHI-Ellipses on Japanese Yen Cash Currency Sample Data

To begin our discussion of applications of PHI-ellipses to market data, we first show a daily chart of the Japanese Yen cash currency with no added tools.

In Figure 5.24, the plain chart represents just the datastream and enables the analyst to see how PHI-ellipses will later fit into the overall picture. The second chart in Figure 5.24 contrasts the set of



O-H-L-C (open-high-low-close) data by integrating PHI-ellipses, which serve as the backbone of our analysis of the relevant market moves.

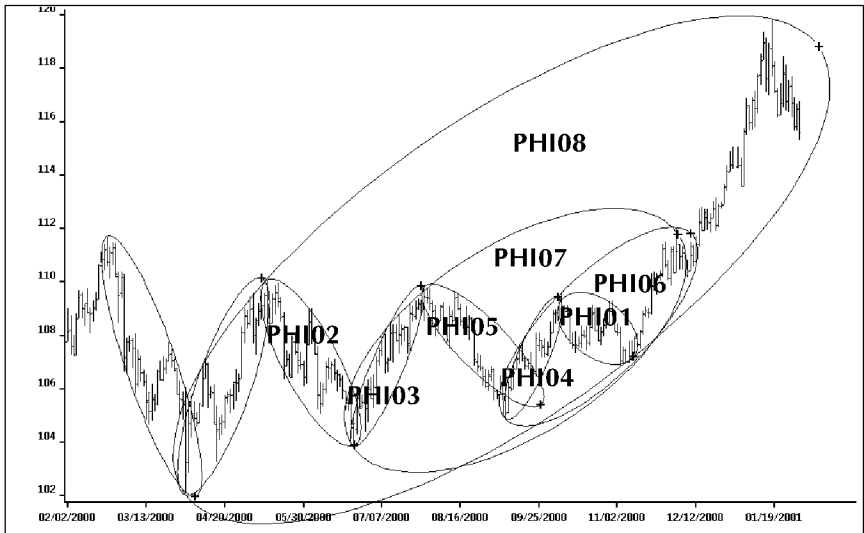
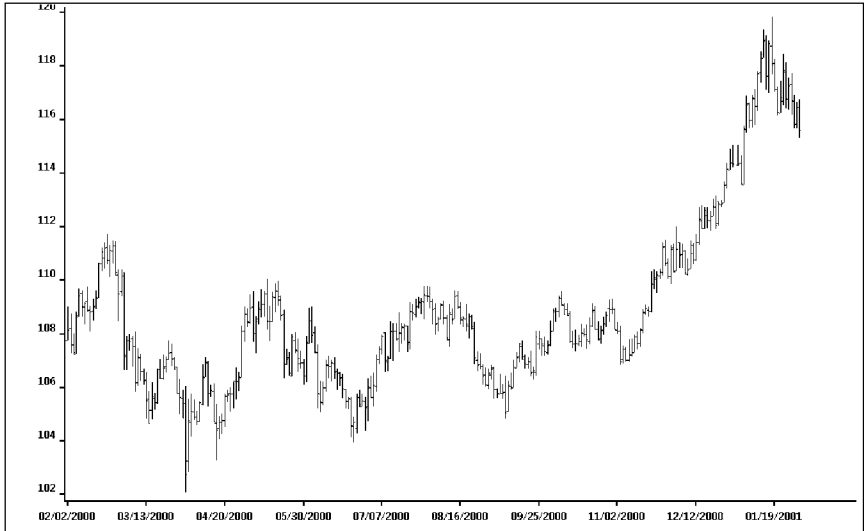

Figure 5.24 Japanese Yen chart from 02–00 to 02–01. Plain O-H-L-C price move and price move with PHI-ellipses PHI01 to PHI08.



The relevant PHI-ellipses have been numbered PHI01 to PHI08 in Figure 5.24. We refer, consecutively, to all eight PHI-ellipses and demonstrate in depth how they were generated.

The basic structure of PHI-ellipses is always the same. When drawing a PHI-ellipse, its borders must define and touch at least four points. The four points are (1) starting point of the PHI-ellipse, (2) left side, (3) right side, and (4) bottom of the PHI-ellipse.

The starting point is usually the highest or lowest point in a price move. But there are exceptions in patterns such as irregular tops or bottoms, overlapping PHI-ellipses, or very small angles in a PHI-ellipse.

PHI-ellipse PHI01 (isolated in Figure 5.24) consists of a simple 3-wave pattern that should, by now, be familiar to readers (see Figure 5.25).

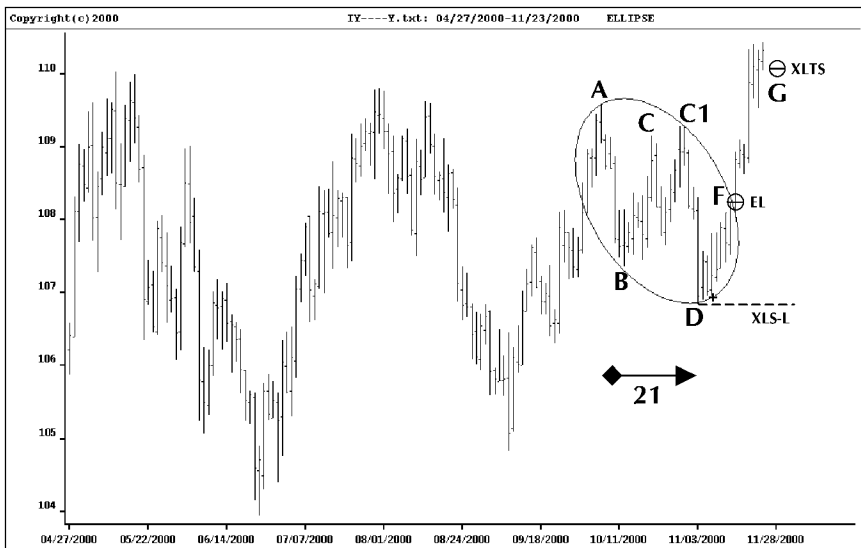

Figure 5.25 Japanese Yen chart from 04–00 to 11–00. PHI-ellipse PHI01.

The starting point in PHI01 is A, and the first of the two side points is B. We can already draw a PHI-ellipse through the peak at point C, but to complete a PHI-ellipse in a 3-wave pattern, the third

wave has to go lower than point B. The price move does not go lower than point B after reaching C. Instead, it makes a higher high than C, changing the side point from C to C1. This may happen at any time when we work with PHI-ellipses.

From C1, the price move goes quickly to point D. However, at valley D, we do not know whether this is the low to watch; for even though we can draw the PHI-ellipse through point D in its final form, we have to wait for the market price to go outside the PHI-ellipse at point F.

Our Fibonacci count can be used as an additional indicator to determine whether point D is actually a significant low point. Valley D occurs one day after number 21 of the Fibonacci summation series (the count beginning once starting point A has been reached). The number 21 is a very important Fibonacci count that is always worth checking.

At point F, where the market price move leaves PHI-ellipse PHI01, a trading signal is generated and executed based on the following three parameters:

1. Entry market as soon as the border of PHI01 is broken. No further entry rules apply because the entry level is already far above the previous 4-day high.
2. Stop-loss protection set to the valley at point D, which is the lowest low inside PHI01.
3. Trailing stop to protect profits, defined as a breakout of a previous 4-day low. The trailing stop formation is triggered at point G.

The simple PHI-ellipse PHI01 is a convincing example of how successful signals can be derived straight from the core application of this trading tool. From this basic example, we can proceed to much more complex formations that are also subject to analysis on the basis of PHI-ellipses.

PHI02 has a much thinner and longer form than PHI01 because the price pattern is not a 3-wave move, but a 5-wave move. The first swing A to B and back to C is established quickly, but a PHI-ellipse drawn around these swings has no stability. After the following waves to the valley at point D and the peak at point E have established side points determining the final shape of PHI02, we will then



be able to correctly draw PHI02 to generate a trading signal (see Figure 5.26).

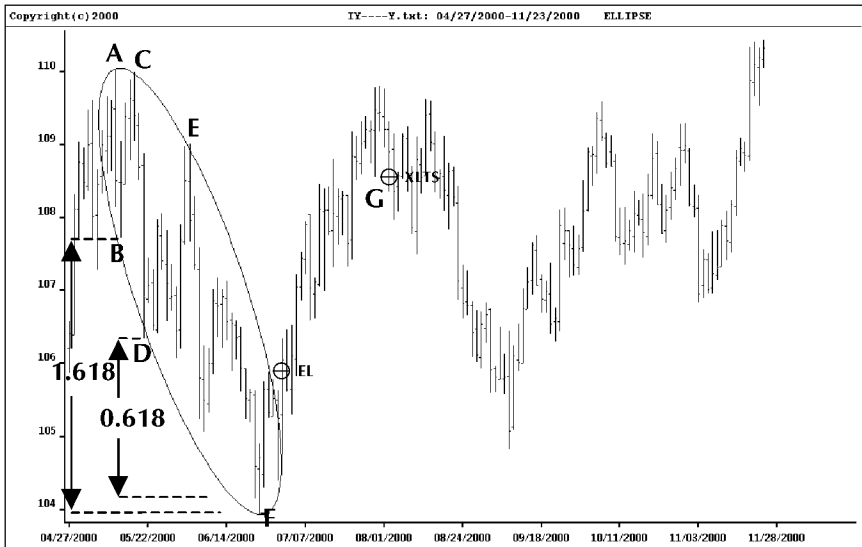

Figure 5.26 Japanese Yen chart from 04–00 to 11–00. PHI-ellipse PHI02.

In addition to noting the shape of PHI02, it is important to measure the underlying 5-wave swing based on extensions of wave 1 and also wave 3. The amplitude of wave 1, multiplied by the ratio 1.618, and the amplitude of wave 3, multiplied by the ratio 0.618, both point closely to valley F, which then marks the final point of PHI02 (readers who get confused here, please review the Chapter 3 discussion of extensions in 5-wave patterns).

The day of the lowest low is day 32 (counted from the high of the first impulse wave of the price move at point A), which is too close to the Fibonacci count of 34 to ignore.

The turning point in the Japanese Yen cash currency market just below 104.00 JPY is confirmed through four methods: (1) Elliott 5-wave count, (2) the ratio 1.618 on wave 1, (3) the ratio 0.618 on wave 3, and (4) PHI-ellipse PHI02. Here, aggressive investors find four good reasons to buy U.S. Dollars and sell Japanese Yen immediately at a level of 104.00. Somewhat conservative investors, however, should wait to

get the final confirmation at the point where the market price moves out of the sideline of PHI02.

The second approach leads to the following trading outcome:

- Entry on a breakout of a previous 4-day high after PHI02 is left by the price move.
- Stop-loss protection set to the valley at point F, which is the lowest low inside PHI02.
- Trailing stop to protect profits, defined as a breakout of a previous 4-day low. The trailing stop formation is triggered at point G.

As mentioned, a minimum width is necessary to work properly with PHI-ellipses as trading tools. The smaller PHI-ellipses become, the higher the ratios from the PHI series must be to draw PHI-ellipses around price moves.

PHI03 is a typical example of a very narrow PHI-ellipse (see Figure 5.27).

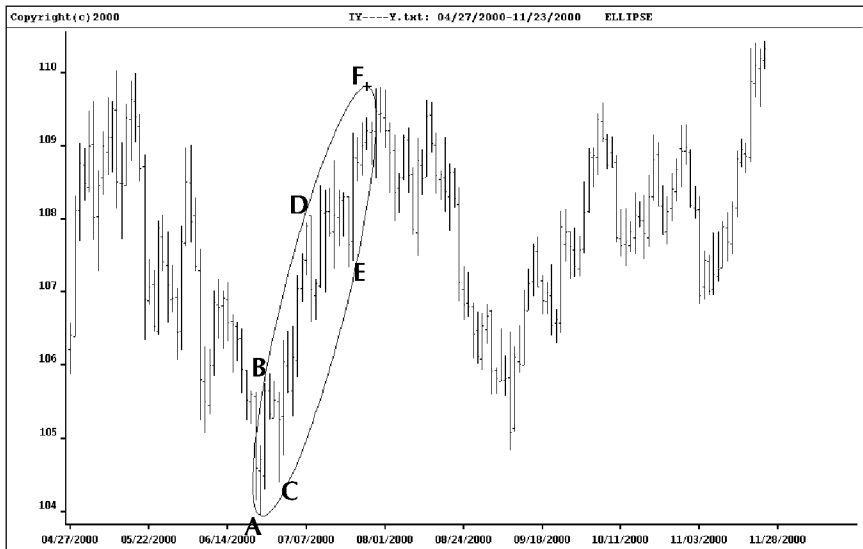

Figure 5.27 Japanese Yen chart from 04–00 to 11–00. PHI-ellipse PHI03.

Analyzing the 3-wave move from A to B back to C shown in Figure 5.27, we find that it takes only 5 days to complete the entire swing before the market price accelerates sharply above the significant peak at point B of the swing.

Although PHI03 can be drawn after the side points D and E have been established, we do not invest in such PHI-ellipses because the width is too narrow. PHI03 is drawn at a ratio 46.979 from the PHI series. This ratio is far beyond the limit of a ratio 17.944, which is the highest ratio from the PHI series that is appropriate for an application to PHI-ellipses (see Figure 5.1 for a recap).

The same holds true for PHI04, which is drawn at ratio 29.034 from the PHI series (PHI04 is part of the overall picture in Figure 5.24).

The first four examples were selected to introduce trading decisions based on PHI-ellipses. PHI05 shows that making trading decisions is sometimes difficult because various options exist on the entry side as well as on the exit side (see Figure 5.28).

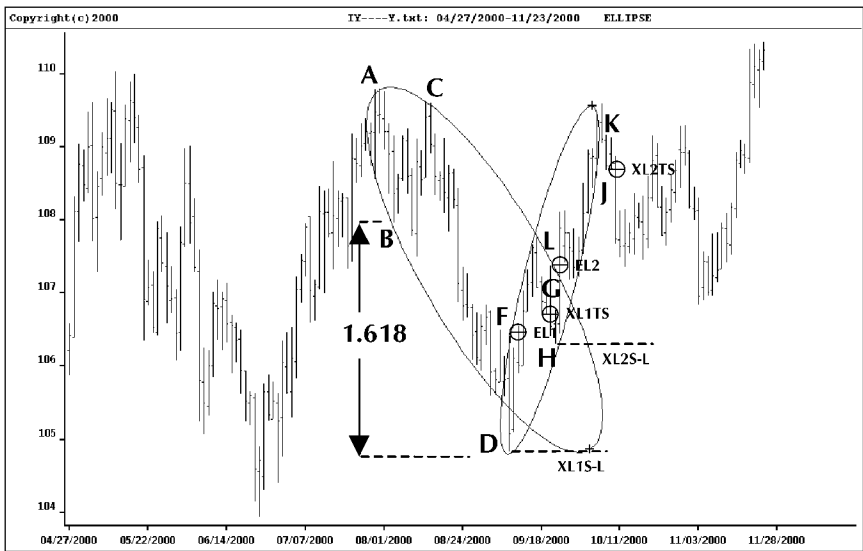

Figure 5.28 Japanese Yen chart from 04–00 to 11–00. PHI-ellipse PHI05 (in combination with the narrow PHI-ellipse PHI04 for the exit rule).

PHI05 begins with a strong first wave from starting point A to point B. Point B is part of the a, b, c correction in the second wave and does not touch the outside line of the PHI-ellipse. Point C becomes the second side point of PHI05 as soon as the market price moves lower than point B. The third wave of the price move goes very quickly from point C to D. Point D is the end of the price move. Market pricing reverses at point D for two possible reasons:

1. Point D does not go lower than the bottom of the PHI-ellipse.
2. Point D is almost exactly the price target of the extension calculated from impulse wave 1, which goes from point A to point B.

Even though point D is confirmed by multiple Fibonacci tools, before we can invest, we need a confirmation of a trend reversal. Two options exist for a buy signal.

The first option has the following parameters:

- No waiting for PHI05 to be broken to the right side and entry to the market on a breakout of a previous 4-day high. This entry rule is filled at point F in Figure 5.28.
- Stop-loss protection set to the valley at point D.
- Trailing stop to protect profits defined as a breakout of a previous 4-day low. The trailing stop formation is triggered at point G.

The second of the two options for entering the Japanese Yen cash currency market long works with a different set of parameters:

- Initial buy when the sideline of PHI05 is broken at point L, which is also higher than the previous 4-day high.
- Stop-loss protection set to the swing low at point H.
- Trailing stop to protect profits defined as a breakout of a previous 4-day low. The trailing stop formation is triggered at point J.

Using the second option, we can close out the position by combining PHI05 with PHI04, which is the one we do not consider on the



entry side because it is drawn at too high a ratio from the PHI series. We exit our position at point K (Figure 5.28) when the market price breaks through the sideline of PHI04.

PHI-ellipse PHI06 is an example of capturing a medium-term 3-wave uptrend over three months and generating a short signal from it (see Figure 5.29).

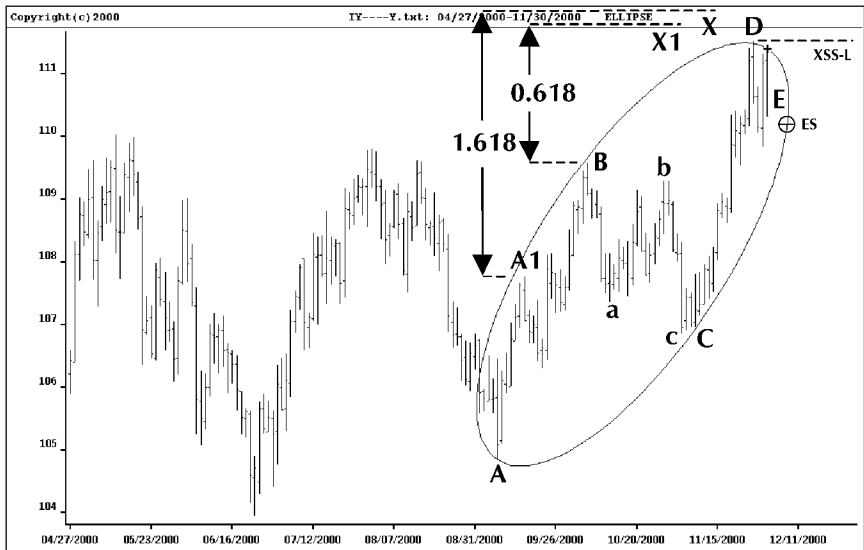

Figure 5.29 Japanese Yen chart from 04–00 to 11–00. PHI-ellipse PHI06.

PHI06 is based on the symmetrical price move from points A to B to C to D. The 3-wave swing has an a–b–c correction in wave 2, which at the same time gives shape to PHI01 (see Figure 5.25).

Our basic investment decision is countertrend at point D. Two price goals X and X1 confirm the trend reversal at point D. We reach goal X by multiplying the amplitude of the price move from A to A1 by the Fibonacci ratio 1.618. Price goal X1 is defined by multiplying the amplitude of the market move from point A to point B by the ratio 0.618. Both price targets X and X1 are close enough together to lead to strong resistance at these price levels and a high probability of a trend reversal as soon the target prices are triggered on the uptrend.



To invest on PHI06, we have two more options. The relevant factors of the first option are:

- Immediate entry short at point D on a previous 4-day low, due to the confirmation of the trend reversal by the price goals X and X1, even if PHI06 has not been broken. The entry rule is filled at point E.
- Stop-loss protection set to the highest high at point D.
- Trailing stop to protect profits defined as a breakout of a previous 4-day high as long as the short position has not been stopped out in a loss.
- Definition of profit target levels at 38.2 percent, 50.0 percent, and 61.8 percent of the distance measured from points A to D alternatively to the trailing stop exit rule.

The second option runs a little differently and delays the entry. This is because we wait conservatively for the final point of PHI06. We use the following set of parameters:

- Entry short on a previous 4-day low after the market move left PHI06.
- Stop-loss protection set to the highest high inside PHI06.
- Trailing stop to protect profits, defined as a breakout of a previous 4-day high as long as the short position has not been stopped out in a loss.
- Definition of profit target levels at 38.2 percent, 50.0 percent, and 61.8 percent of the distance measured from points A to D alternatively to the trailing stop exit rule.

It depends on the risk preference of investors whether an entry on the double confirmation of the trend reversal by two Fibonacci extensions is solid or whether sticking with the overall rule of first waiting for the final point of PHI06 remains preferable.

With PHI07, the perspective once again broadens and shifts from midterm to long-term analysis.

PHI07 is a splendid example of how investors can identify patterns with PHI-ellipses and use pattern recognition over the short



term, midterm, and long term. Investors' behavior is expressed in both small and big patterns, which in the end are all integrated into the same picture, as shown in Figure 5.30.

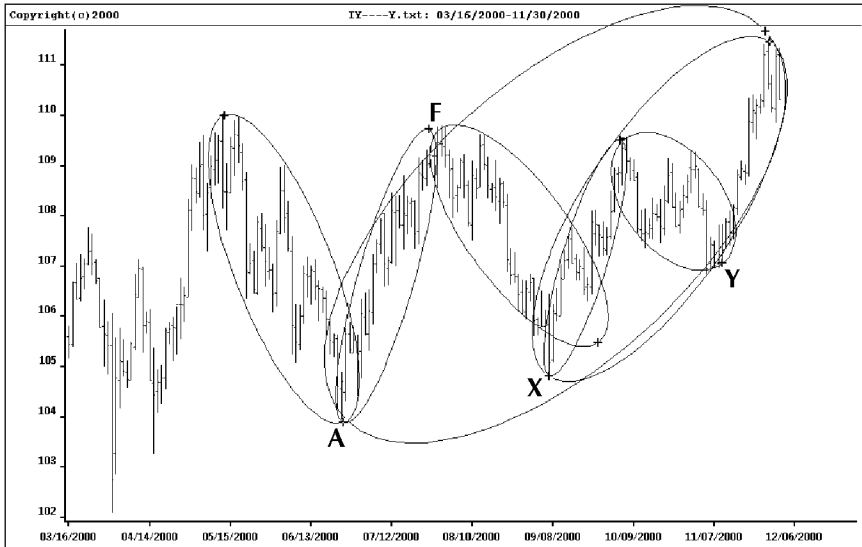

Figure 5.30 Japanese Yen chart from 04–00 to 11–00. PHI-ellipse PHI07.

PHI07 circumvents five of the six PHI-ellipses discussed thus far. Only PHI02 is not circumvented by PHI07. As mentioned, PHI-ellipses develop over time, and it is important to be patient and wait until the total picture reveals itself.

The first critical point in the development of PHI07 is point X as the side point of the 3-wave pattern from A to F and back down to X (Figure 5.30). The side point X changes to side point Y at the same moment that PHI01 reaches its final point. The final shape of PHI07 is realized when the side point changes from X to Y and when the final point of PHI06 is reached, merging with the final point of PHI07.

Such a phenomenon seldom occurs, and is only documented in a long-term analysis with multiple PHI-ellipses. Our findings demonstrate how important it is to combine the short-term and long-term

perspectives of investment strategies. The beauty of Fibonacci trading tools is that they work perfectly together.

According to the general investment rules on PHI-ellipses, the final points of PHI06 and PHI07 provided opportunities for establishing a short position. However, the market in Japanese Yen cash currency did not go lower, as assumed, but higher (see Figure 5.31).

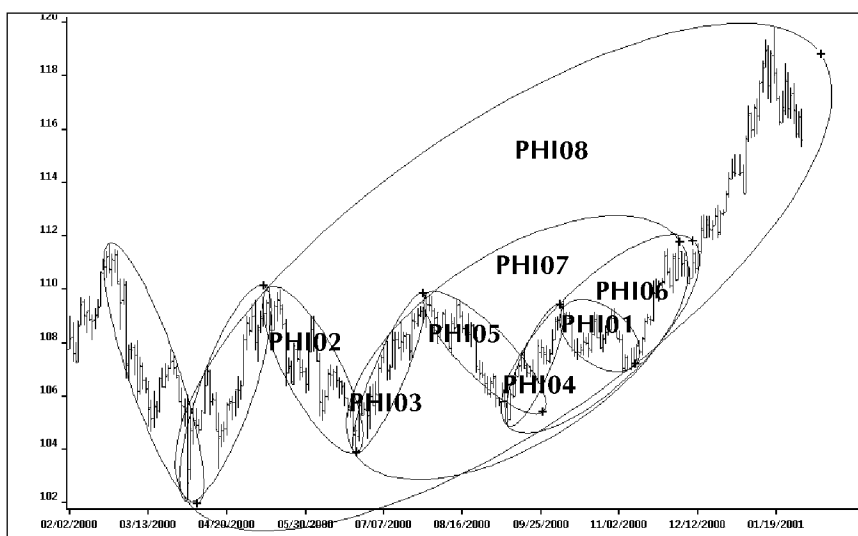

Figure 5.31 Japanese Yen chart from 02–00 to 02–01. PHI-ellipse PHI08.

A pattern like the one shown in Figure 5.31 is a rare exception, but it confirms that the end of a PHI-ellipse is either an indication of a trend change in the opposite direction or a breakout in the main trend direction.

In most cases, the market price reverses at the final point of a PHI-ellipse. But the long-term picture in the Japanese Yen cash currency reveals that after selling short at the end of PHI06 (or PHI07) and getting stopped out of the short position, it is wise to reverse the position to the long side. There is enough trading potential to the

upside, represented by PHI08, which is well established and defined by the starting point and two side points.

Examples like the short trades on PHI06 and PHI07 make it clear that Fibonacci tools are ordinary trading tools. This means that even on the best looking patterns, trades might turn out to be losing. As long as traders work with a solid stop-loss rule, any harm done by losing trades remains under control. To increase the profitability of investments, we recommend combinations of Fibonacci trading tools, candlesticks, and chart pattern recognition.

PHI-Ellipses on S&P 500 Index Sample Data

Trading the PHI-ellipse is the sort of improved trading approach that was described in Chapter 4. This approach works on every product, stocks, stock indexes, financial futures, or commodities.

We do not think that trading signals with PHI-ellipses can be computerized since the strength of the PHI-ellipse—adjusting dynamically to every price move—is very difficult to program. However, the sophisticated trader who has learned to adjust the PHI-ellipse to different price moves can easily trade it by hand. Our Web site, www.fibotrader.com, provides a model portfolio with advice on how to trade the markets using the PHI-ellipse.

In most cases, trading with the PHI-ellipse means trading counter to the market trend direction, but occasionally the trades go in line with the trend direction. In our long-term example on the S&P 500 Futures Index, we show some of these trades as well.

To trade systematically with the PHI-ellipse, we have to introduce an entry rule, a stop-loss rule, and a trailing stop rule.

Under normal circumstances, we enter the markets counter to the main trend direction. The entry rule is filled when the outside line of the PHI-ellipse and the most recent peak or valley are broken. The peak/valley breakout condition is an amendment to the entry rule described in Figure 5.13.

The reason for introducing the peak/valley breakout as an amendment to the general rule is that the entry signals are often generated after a failure in the price move. The peak (on short entries) or valley (on long entries) may show up before or after the market price



move breaks the outside of the PHI-ellipse that we are watching for our market entry.

The stop-loss level on countertrend entries is the most recent peak (or valley) generated after the sell (or buy) order was filled (see Figure 5.32).

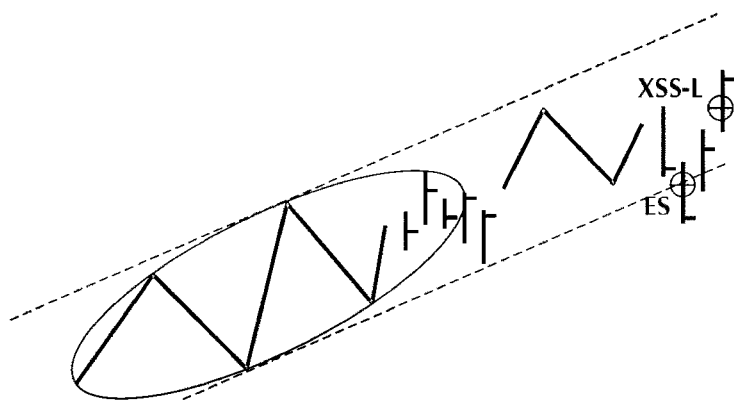

Figure 5.32 Stop-loss on a recent peak breakout on a short position.

Once we are stopped out, we have to wait for a new outside line of the PHI-ellipse to be broken (in accordance with our entry rule).

In two exceptional cases, we enter the market in line with the major trend direction. The first case is the sideward market manifested in a horizontal PHI-ellipse, as illustrated in Figure 5.33.

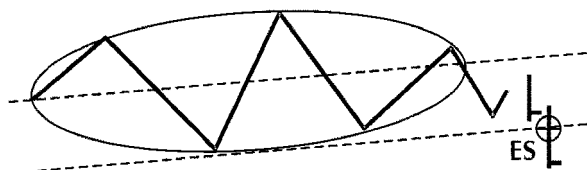

Figure 5.33 Establishing a short position on a horizontal PHI-ellipse.

In a sideward market, there is no major trend direction. We enter the market short (or long) in line with the short-term trend as soon

as the outside line of the horizontal PHI-ellipse and a valley (or peak) are broken.

When we buy or sell at the end of a PHI-ellipse, we rarely get stopped out. If we find the scenario of a runaway market, we reverse our position at the stop-loss level (see Figure 5.14 for a recap).

To exit our positions, we apply trailing stops and define them as the most recent peaks (on short positions) and valley (on long positions) in a profit. This is a slight modification of the 4-day high/low breakout trailing stop rule from Figure 5.16.

The peak and valleys used as trailing stops should not be defined in a too sensitive manner. They should consist of at least two lower highs (for peaks) or two higher lows (for valleys) on either side of the highest high or lowest low.

In our S&P 500 Index trading example on daily data, we show a total of 15 signals between February 2001 and November 2002 (see Figure 5.34).

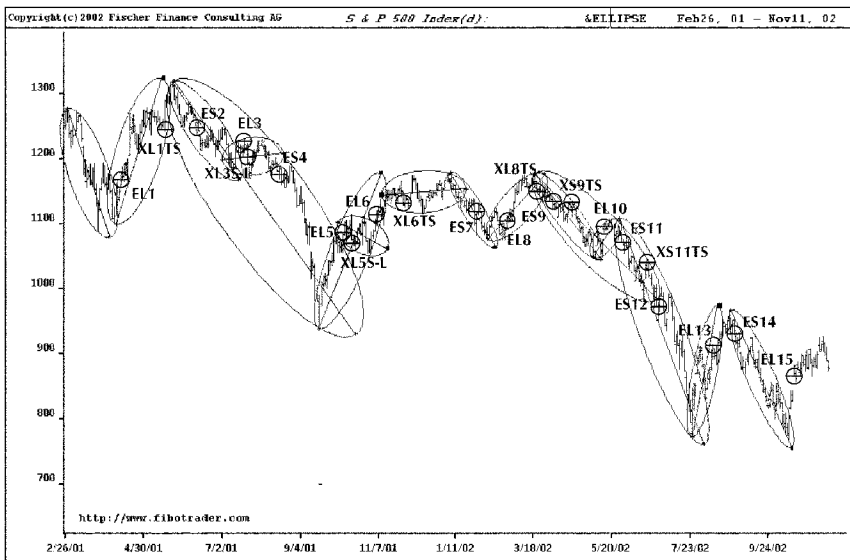

Figure 5.34 S&P 500 chart from 02–01 to 11–02. Simulation of trading signals based on PHI-ellipses daily (EL: entry long, ES: entry short, XL: exit long, XS: exit short, S-L: stop-loss, TS: trailing stop).

Generalizing the quality of this trading approach is impossible with a time period of just 22 months and signals for only one product. Nevertheless, because the test period includes uptrends, downtrends, and sideward market conditions, it clearly indicates the potential of trading PHI-ellipses.

To avoid complicating the chart with too many outside lines, we show only the relevant PHI-ellipses and omit the outside lines of the PHI-ellipses. Interested readers can work with the WINPHI program and the data on the CD-ROM to generate the same signals and study the concept. Profits and losses can be checked trade by trade according to Table 5.1.

Table 5.1 Trading Signals

#	Entry Rule	At	Exit Rule	At	Profit/ Loss in Points
1	Buy long	1,165.00	Trailing stop	1,244.00	79.00
2	Sell short	1,248.00	Buy reverse	1,228.00	20.00
3	Buy reverse	1,228.00	Stop-loss	1,202.00	(24.00)
4	Sell short	1,174.00	Buy reverse	1,087.00	87.00
5	Buy reverse	1,087.00	Stop-loss	1,073.00	(14.00)
6	Buy long	1,115.00	Trailing stop	1,131.00	16.00
7	Sell short	1,117.00	Buy reverse	1,102.00	15.00
8	Buy reverse	1,102.00	Trailing stop	1,154.00	52.00
9	Sell short	1,134.00	Trailing stop	1,132.00	2.00
10	Buy long	1,092.00	Sell reverse	1,077.00	(15.00)
11	Sell reverse	1,077.00	Trailing stop	1,040.00	37.00
12	Sell short	975.00	Buy reverse	912.00	63.00
13	Buy reverse	912.00	Sell reverse	932.00	20.00
14	Sell reverse	932.00	Buy reverse	866.00	66.00
15	Buy reverse	866.00			Open

This trading approach always stays close to the market action. It works best in volatile products such as stock index futures, financial futures, cash currencies, or volatile commodities. It is easy to follow, but it takes discipline to execute the trading signals.

There might be times when there is no peak or valley close enough after the entry and, therefore, the original stop-loss might be



far away. But in general, V-turns after an entry are rare. In all of our sample signals, reasonable peaks or valleys are formed by the price action after the entry, thus reducing the original stop-loss risk substantially. On the other hand, the trading approach catches major market trends as well.

However, when running this concept as a trading approach, it is best not to start with too much leverage.

PHI-ELLIPSES ON CONSTANT SCALES

The PHI-ellipses work equally well on daily, weekly, and monthly charts.

Hourly charts are interesting for analysis on intraday data, for they show a very short-term picture. The problem with intraday charts is that entry rules, profit targets, and stop-loss rules may leave investors with small profit potentials. On the other hand, the overall risk (per trade) also is limited.

The risk level is one of the reasons we enjoy working with cash currencies on a daily basis: Cash currencies trade 24 hours a day without gap openings and other inconveniences that may dilute the performance profile.

Long-term historical test runs are necessary to judge the quality of PHI-ellipses for products to be traded. A feature for plotting historical data to charts with a constant price scale has been integrated into the WINPHI software. Two or three years of daily O-H-L-C data are impossible to plot to the width of one screen, and when scrolling the screen, the price scale usually varies according to the highest high and the lowest low of the data. The WINPHI constant scale feature is a key element, because scaling to screen height would otherwise distort the angles of PHI-ellipses applied to market moves.

PHI-Ellipses on Constant Scales in the Japanese Yen Cash Currency

We have analyzed more than two years of the Japanese Yen cash currency daily bar data, from September 1998 to December 2000, and have backtested the PHI-ellipses.

The total stream of data over 27 months is divided into two charts. By choosing a set of appropriate PHI-ellipses and waiting for



market pricing to move out of them at their final points, our sample investments follow the price pattern in the Japanese Yen cash currency with very few exceptions (see Figure 5.35).

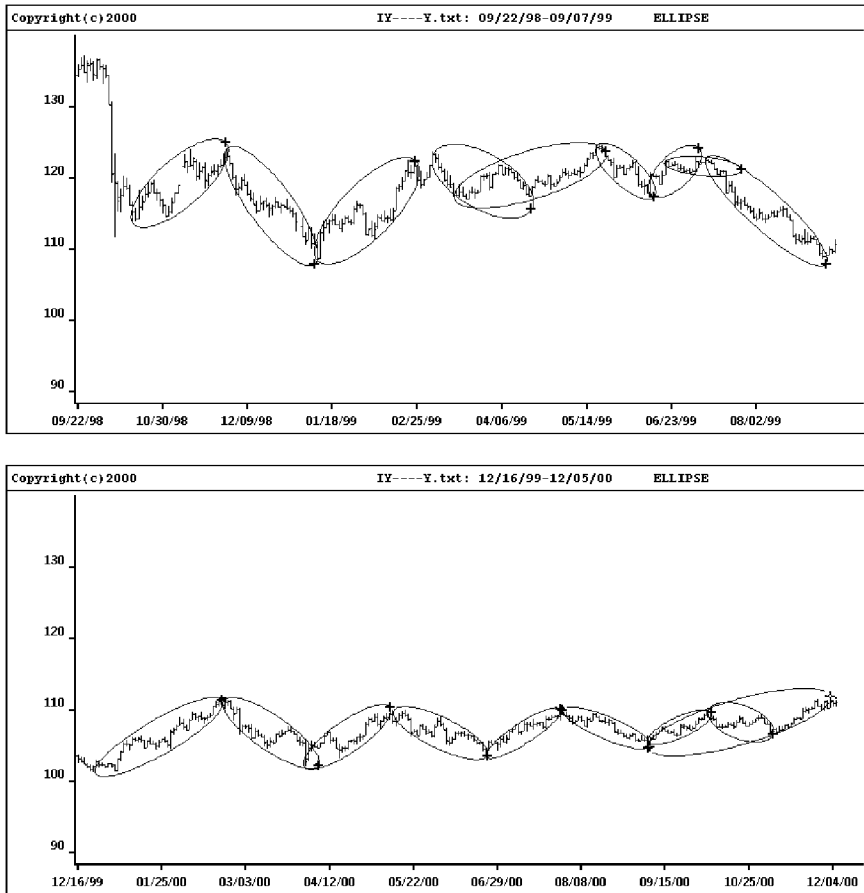

Figure 5.35 Japanese Yen chart from 09–98 to 12–00. Attached and overlapping PHI-ellipses on a constant scale.

Working with a constant scale feature is the only way in geometrical chart analysis to achieve an undistorted picture over such a long period.

It is often difficult to believe in the power of the PHI-ellipse. Trading with PHI-ellipses on daily data generates about one trade

per month, depending on whether inside PHI-ellipses are found. The pattern of inside PHI-ellipses can be seen in the time period from September 2000 to December 2000 in Figure 5.35, where three small PHI-ellipses are contained within one bigger PHI-ellipse.

When we look at the charts, we realize it is necessary to adjust PHI-ellipses dynamically to market price action. PHI-ellipses are unique; not one PHI-ellipse is exactly like another even though the shape is always the same. All PHI-ellipses in our sample calculation have two elements in common: (1) Both sides of all PHI-ellipses are touched, at least once during a price move, so that there is always a 3-wave pattern; and (2) all PHI-ellipses are at least 21 days long and are drawn at a ratio smaller than 17.944 from the PHI series.

In addition, most PHI-ellipses start at the end of the preceding PHI-ellipse. Only in an exceptional case (see April 1999, in Figure 5.35), does a PHI-ellipse start when the previous PHI-ellipse is only half finished.

Keeping in mind constant scales and the long-term picture of market price patterns, we now move to the second sample: the S&P 500 Index.

PHI-Ellipses on Constant Scales in the S&P 500 Index

If we can demonstrate that PHI-ellipses work with many products over a longer period, we can be confident in our investments. It is only on constant scales that we see the similarities of different PHI-ellipses. Each PHI-ellipse varies in shape, length, or width, but the underlying principles based on the Fibonacci summation series and the ratios from the PHI series never change.

There is no standard PHI-ellipse that is the average fit for every price move. However, the magic of PHI-ellipses lies in their ability to dynamically adjust to ever-changing price patterns in the markets.

We have analyzed more than two years of S&P 500 Index daily bar data from December 1998 to December 2000, and have backtested the PHI-ellipses.

The total stream of data over the 25 months is separated into three charts, as shown in Figure 5.36. By choosing a set of appropriate PHI-ellipses and waiting for market pricing to move out of the



PHI-ellipses at their final points, our sample investments follow the price pattern in the S&P 500 Index with few exceptions.

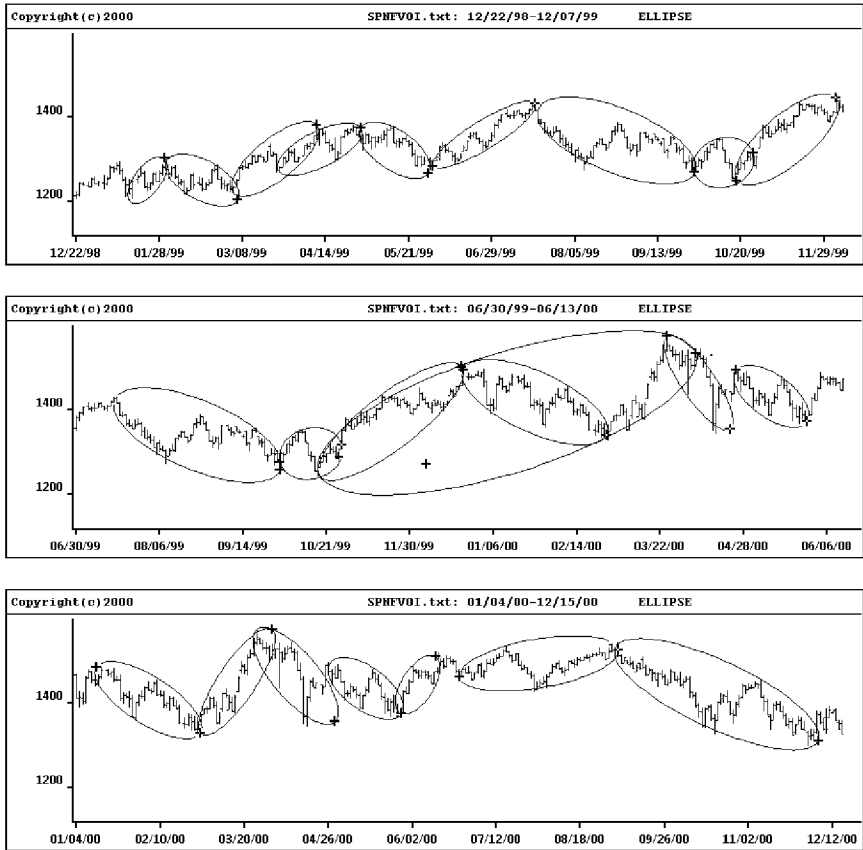

Figure 5.36 S&P 500 chart from 12–98 to 12–00. Attached and overlapping PHI-ellipses on a constant scale.

Taking into account the 15 attached and overlapping PHI-ellipses analyzed in the previous section on daily bar data in the S&P 500 Index and the total 23 PHI-ellipses shown in Figure 5.36, the dynamic nature of PHI-ellipses becomes evident.

PHI-Ellipses on Constant Scales in the Dax 30 Index

The total stream of market data over 27 months from September 1998 to December 2000 in the Dax 30 Index is shown on constant scales on the two charts in Figure 5.37.

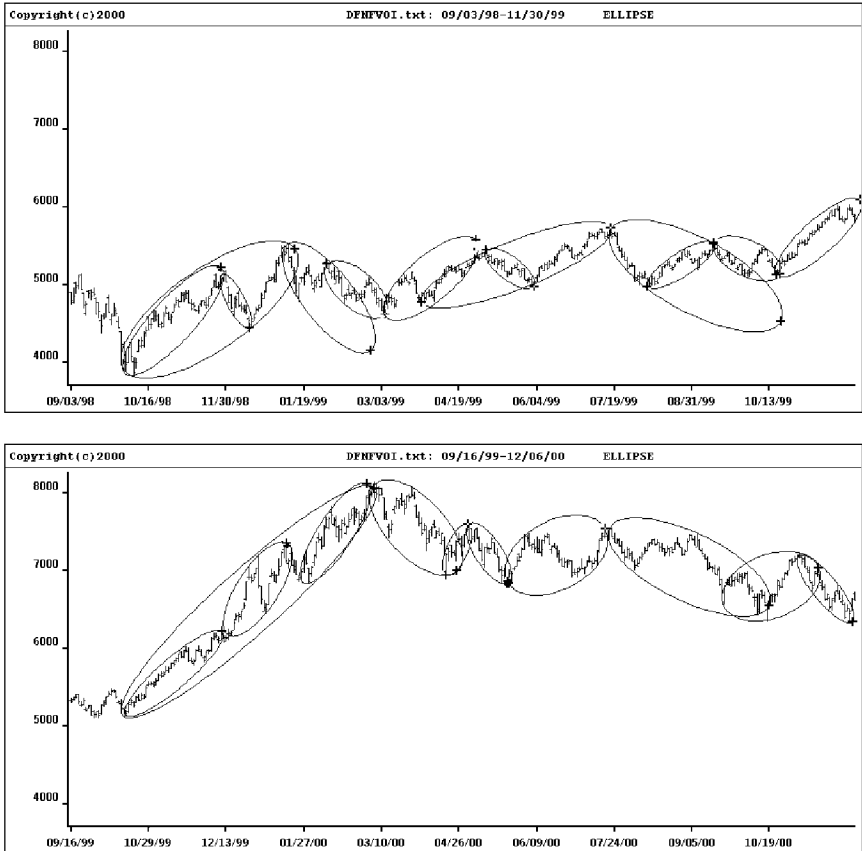

Figure 5.37 Dax 30 chart from 09–98 to 12–00. Attached and overlapping PHI-ellipses on a constant scale.

Once again, we must find a set of appropriate PHI-ellipses and wait for market pricing to move out of the PHI-ellipses at their final

points. PHI-ellipses overlap or are attached to each other and follow the market price pattern in the Dax 30 Index.

The change in shape of the PHI-ellipses depends greatly on whether the basic underlying market pattern is a 3-wave move or a 5-wave move. Properly distinguishing between 3-wave swings and 5-wave swings was the key problem that Elliott and his followers were never able to solve. PHI-ellipses as Fibonacci trading tools solve this problem. It does not matter whether we deal with a 3-wave pattern or a 5-wave pattern, for the final point of a PHI-ellipse tells us where we are in the market.

WORKING WITH PHI-ELLIPSES ON INTRADAY DATA

To get a more stable equity curve, many traders rely on intraday data. The goal is to participate on small price swings with a high number of profitable trades at very low risk.

However, inexperienced traders often quickly learn that faster trading not only means higher slippage and commission, but also requires greater discipline in executing trading signals. Traders who do not have systematic rules for trading intraday should be very careful. The best strategy is to start with paper trading and work with different products and time intervals.

There are many possibilities for intraday trading. In this discussion, we focus on 15-minute data, for this is the data compression we offer on our online trading platform www.fibotrader.com. PHI-ellipses can be traded very successfully on 15-minute data. We use Dax 30 Futures Index data in this section because this is the product we trade for ourselves. But DJ EuroStoxx 50 Futures Index, S&P 500 Futures Index, Nasdaq 100 Futures Index, and Dow Jones Futures Index are also excellent trading instruments on intraday data in combination with PHI-ellipses.

Trading Rules

The PHI-ellipse can be used on any kind of intraday data—60-minute, 30-minute, 15-minute, 10-minute, or 5-minute data—since investor behavior expressed through the PHI-ellipse does not change.



As mentioned, other charting programs have ellipses as well. We have worked with PHI-ellipses for more than 20 years in real-time trading and had to transform the underlying formula for the regular ellipse into the PHI-ellipse formula to make this trading tool work. The main difference between the PHI-ellipse and other ellipses is that the PHI-ellipse keeps its shape much longer. In addition, PHI-ellipses always integrate a Fibonacci ratio; other ellipses do not do this.

Entry Rules

When we generate trading signals with the PHI-ellipse, our entry signal is the outside line of the PHI-ellipse, which is the parallel to the median line of the PHI-ellipse.

Alternatively, conservative traders should wait until a price bar breaks the outside line of the PHI-ellipse. The high or low of the price bar at which the breakout occurred is then the entry point (see Figure 5.38).

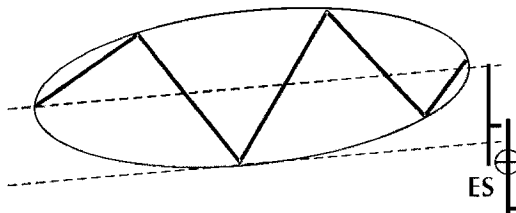

Figure 5.38 Entry rule on a short position.

This additional requirement means that we will always be a little bit later in the market than if we had bought or sold immediately on the breakout, but on the other hand, we eliminate a lot of false signals.

Stop-Loss Rules

Every product has its own volatility and, therefore, requires a different stop-loss rule.

In general, if we work with a horizontal PHI-ellipse, the stop-loss can always be the median line of the PHI-ellipse.

As an option, we can work with a stop-loss expressed in basis points. For example, in the Dax 30 Index, we recommend a stop-loss of 30 basis points.

The third option would be to start with the stop-loss at the median line and wait to see whether the market price reaches a new peak (on short positions) or valley (on long positions). We then reduce (or raise) the stop-loss to this new level, as illustrated in Figure 5.39.

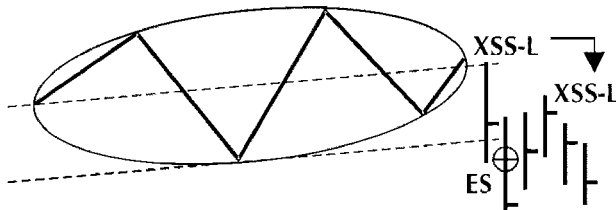

Figure 5.39 Stop-loss rule on a short position.

Profit Target Rules

The best way to define a profit target is to wait after the market entry until near the end of the trading session, and then close the position five minutes before the end of the session.

As an alternative, we can close the position when the market price reaches a profit target that, pointwise, is as big as the height of the PHI-ellipse that generated the trading signal (see Figure 5.40).

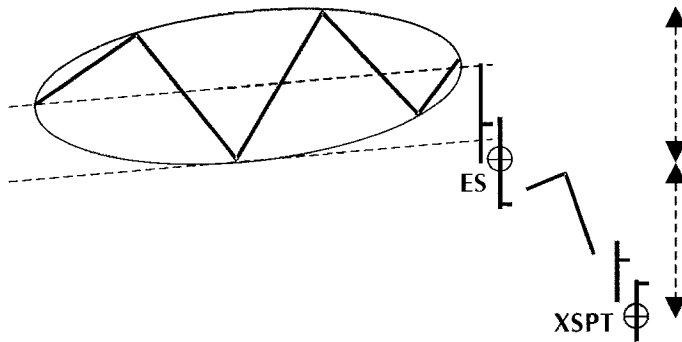

Figure 5.40 Profit target rule on a short position based on the initial width of the PHI-ellipse.

The advantage of this strategy is that the profit target will always be dynamically adjusted to the volatility of the market swings by the time the signals are generated.

PHI-Ellipses and Symmetry in Price Patterns

Market price patterns develop based on investor behavior. It is a general belief that investor behavior is an irrational parameter that cannot be analyzed.

We have a different opinion. Certain price patterns in each price move are very repetitive and can be used for the analysis if the trader is patient enough to wait for them. The PHI-ellipse can identify those symmetrical price patterns to use as trading information.

In Figure 5.41, we present a pair of examples of symmetrical price patterns on the Dax 30 Index. In both examples, the low point of the price pattern within the PHI-ellipse is located almost in the middle between the peaks on the right and left side. The PHI-ellipse runs almost horizontal.

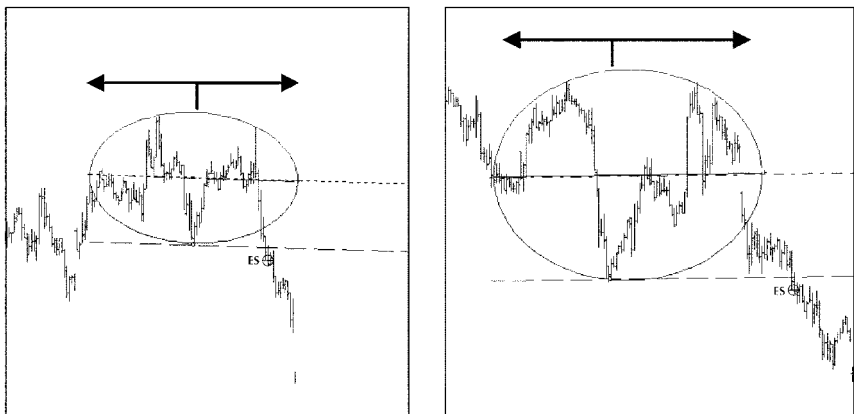

Figure 5.41 Symmetry in price patterns.

It is essential for the two peaks to touch the outside line of the PHI-ellipse, for otherwise the PHI-ellipse would not have a stable form. Creating the charts is possible only because PHI-ellipses can be dynamically adjusted to different market price patterns. The quality of the PHI-ellipse is based on its capability for change according to

the Fibonacci ratios. PHI-ellipses as Fibonacci trading tools are part of the WINPHI software on CD-ROM and can also be found as online trading tools at www.fibotrader.com.

In a second pair of charts, there is also some recognizable symmetry of investor behavior. In contrast to the first examples, the peaks on the right side do not reach the upper borders of the PHI-ellipses (see Figure 5.42, again on the Dax 30 Index).

The PHI-ellipses in these examples do not need the second peaks on the right, because they get their stability through the peaks and valleys that touch the respective median lines.

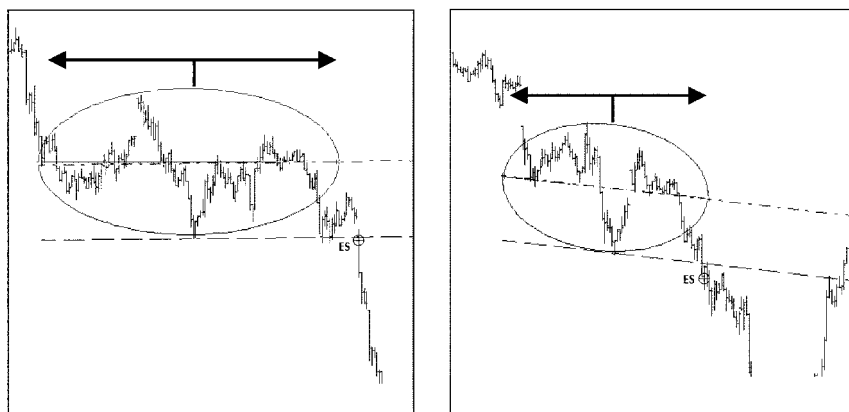

Figure 5.42 Symmetry in price patterns with peak on the right not reaching the upper border of the PHI-ellipse.

Three Peaks (Valleys) at the Upper (Lower) Borders of PHI-Ellipses

Most trading signals generated with PHI-ellipses on intraday data occur when three peaks or valleys are formed at the upper or lower border of the PHI-ellipse.

When three peaks have been established at the upper border of a PHI-ellipse and the parallel to the median line is broken to the downside, we immediately get a sell signal. The opposite strategy holds true for buy signals based on three valleys at the lower border of a PHI-ellipse.

Figure 5.43 shows four examples of short trades with three peaks established at the upper borders of the underlying PHI-ellipses.

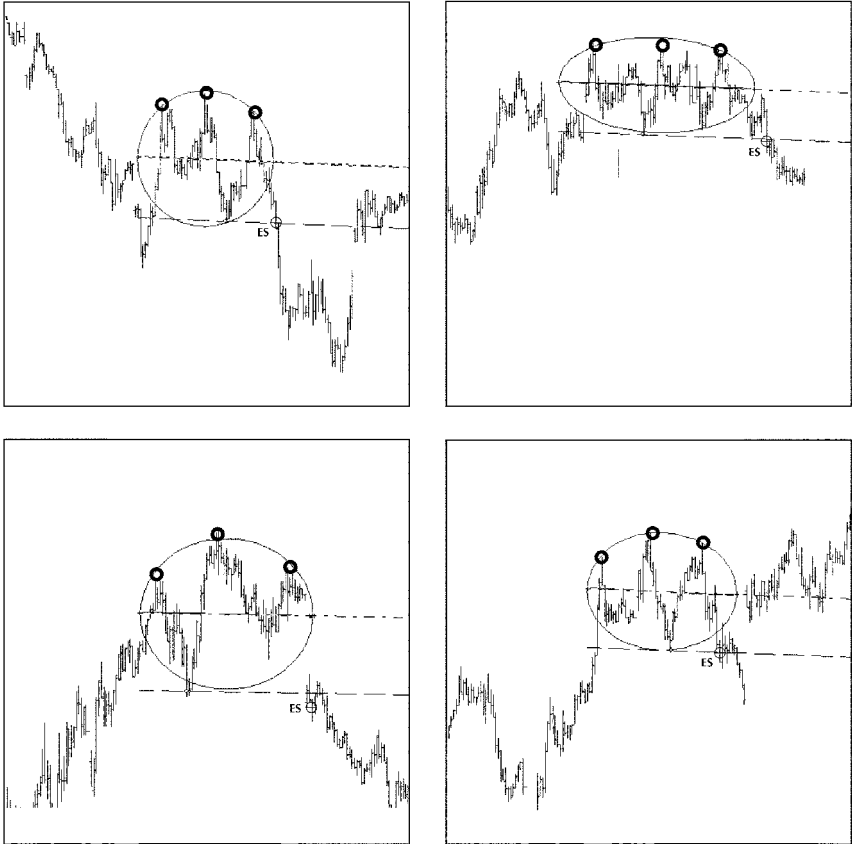

Figure 5.43 Short entries on three peaks at the upper borders of PHI-ellipses.

Once a trading signal is executed, we place a stop-loss and a profit target according to the rules previously described. Trades are closed out by the end of the day.

Breakouts of PHI-Ellipses in the Direction of the Main Trend

In strong market trends intraday, we may get a buy signal on a breakout of the top or bottom at the end of a PHI-ellipse.

Requirements for a valid exceptional trading signal in the direction of the main trend are:

- The slope of the PHI-ellipse is very steep.
- The market price move has touched the PHI-ellipse twice on each side (meaning that the PHI-ellipse has a very stable form), and the breakout occurs at the very end of the PHI-ellipse.
- The entry point for a buy signal is the high of the price bar that broke out of the PHI-ellipse (vice versa for a sell signal).

Figure 5.44 shows examples of a short trade and a long trade in the direction of the main trend at the end of a PHI-ellipse.

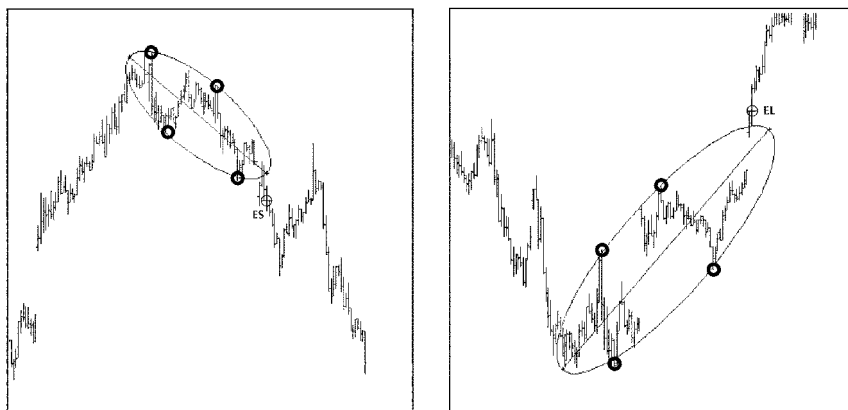

Figure 5.44 Market entries in the direction of the main trend at the final points of PHI-ellipses.

As before, once a trading signal is executed, a stop-loss and a profit target are placed according to the rules previously described. Trades are closed out by the end of the day.

PHI-Ellipses and False Breakouts Intraday

False breakouts are important chart patterns, and PHI-ellipses are reliable trading tools to analyze false breakouts on an intraday basis as well on daily data.

Requirements for a short signal are:

- The slope of the PHI-ellipse has to be modest.
- The false breakout has to be higher than two previous peaks.
- The market price has to drop below the support line (outside line of the PHI-ellipse) that runs parallel to the median line.

These entry rules run vice versa for buy signals. Figure 5.45 shows a pair of sample sell signals from the Dax 30 Index.

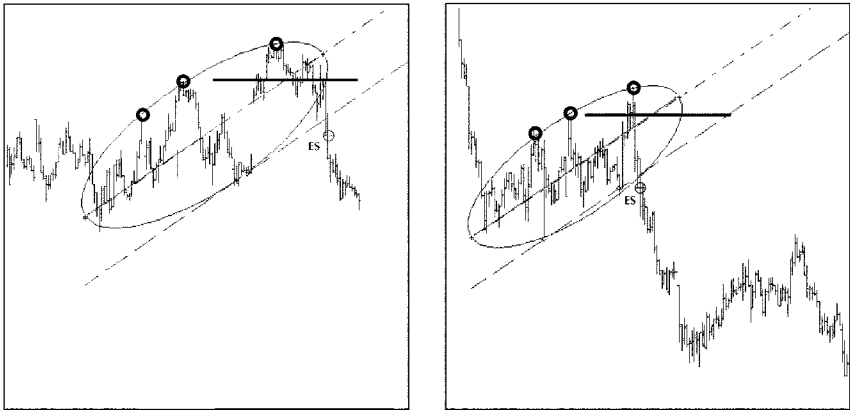

Figure 5.45 Market entries short on false breakouts intraday.

Once again, it is important to place a stop-loss and a profit target immediately after market entry.

RELIABILITY OF PHI-ELLIPSES RECONSIDERED

To summarize our findings on PHI-ellipses as Fibonacci trading tools, we reconsider the reliability of PHI-ellipses in the various fields in which they can be applied to chart analysis. PHI-ellipses as investment devices are special because they make chart patterns visible. When working with PHI-ellipses, investors always know what to look for in the markets no matter how confusing daily, weekly, or monthly

charts may appear. With modern computer technology at investors' fingertips, PHI-ellipses become very valuable.

The basic structure of a PHI-ellipse is simple. PHI-ellipses circumvent a minimum 3-wave swing. To calculate PHI-ellipses, three points are needed, a starting point and two side points. The final point of a PHI-ellipse projects a future market move as the PHI-ellipse develops. The final point of a PHI-ellipse is the decisive point to watch.

In the application of PHI-ellipses, investors are able to master trend patterns and sideward patterns. PHI-ellipses consist of three trading dimensions—price, time, and angle—that are seldom found in a single trading tool. When a solid analysis of all three dimensions precalculates the same turning point in a market, we may invest with confidence.

To make our entry signals safer, we must filter out entry points with a high success rate. This does not mean that every trade will turn out as a winning trade. Getting stopped out on stop-losses and reentering a market while sticking to strict entry rules, stop-loss rules, and reentry rules are all part of using Fibonacci tools in volatile markets. The best entry point on PHI-ellipses with the highest rate of profitable trades only happens at the very end of a PHI-ellipse. The investor should then enter the market counter to the main trend direction.

By generating trading signals based on the end of a PHI-ellipse, we sell high or buy low. A countertrend approach requires considerable discipline, since there is not much support in the markets when a trading signal appears. We will never know whether we meet the highest high or the lowest low at the time we establish a position in a market, but our chances for profitable decisions will be good, at least as far as the historical test runs shown in the preceding sections are concerned.

In the end, the slope of a PHI-ellipse determines whether we receive a trading signal. We will get sell signals as long as the slope of a PHI-ellipse points upward. We will get buy signals countertrend as long as the slope of a PHI-ellipse points downward. In some cases, we will get trading signals in straight sideward markets when a PHI-ellipse runs mainly horizontally.

It boosts our confidence if other Fibonacci trading tools confirm trend reversals derived from PHI-ellipses. These confirmations come either from price analysis based on corrections and extension or time



analysis based on the numbers of the Fibonacci summation series. Valuable confirmations can also come from the application of trend channels.

PHI-ellipses perform well on every product traded as long as there is enough volatility, volume, open interest, and liquidity. For a serious analysis based on PHI-ellipses, we must have an appropriate sample of products in which the international community of investors shows a lot of interest. If investors are interested in a product, it is likely that the product's market patterns will directly reflect investor behavior.

We are always as precise and complete as possible in describing and analyzing trading tools and in applying them to sets of sample market data. We introduce entry rules and exit rules, stop-loss rules, trailing stop rules, and rules for profit targets. However, no matter how much detail we provide, we cannot cover the whole spectrum of opportunities and variations that the analysis of PHI-ellipses implies.

To explain how PHI-ellipses can be applied to real-time trading, we have presented trading signals on daily data of the S&P 500 Futures Index between February 2001 to November 2002. Even though the results look promising, there may be future periods where the signals do not turn out so well.

To prove that PHI-ellipses can be applied to intraday data as well, we have presented some examples on 15-minute price data on the Dax 30 Futures Index. PHI-ellipses have the very best trading potential on intraday data. Although it takes great discipline and accuracy to execute signals, every successful trader has these abilities and can learn how to use this new trading tool. PHI-ellipses work: We use them for our own trading.

We do not believe that the entire spectrum of system design and the development of trading strategies founded on PHI-ellipses can ever be fully automated and computerized. The dynamics of PHI-ellipses and the three dimensions of price, time, and angle would surely be too problematic for programmers. But there is no need for fully computerized trading signals. PHI-ellipses in combination with other Fibonacci trading devices, candlestick patterns, and 3-point chart patterns open the door for skillful, interested, patient, and determined investors who need basic and reliable trading tools that are guaranteed to work, if handled properly.

Generations of investors have tried to apply Elliott's wave principles to successful real-time trading. To the best of our knowledge, no



trader has ever succeeded over a long period of time because Elliott's wave count is not stable. We admire Elliott for his work; his innovative ideas enlightened us and provided the foundation for our own research. With computer technology and our accumulated experience over the past 20 years, we strongly believe that we have raised pattern recognition to a higher level.





abcBourse.ir



@abcBourse_ir

مرجع آموزش بورس



بازنشر:

6

MERGING CANDLESTICKS, 3-POINT CHART PATTERNS, AND FIBONACCI TOOLS

Can we improve the trading strategies based on candlestick chart patterns, 3-point bar chart patterns, and geometrical Fibonacci trading devices if we combine them? Can Fibonacci trading become even safer and more profitable? These are the key questions we consider in this chapter.

Timing is the most crucial element in trading. It is important to know what to buy, but it is even more important to know when to buy. The candlesticks, 3-point bar chart patterns, and Fibonacci trading tools described in the previous chapters can serve investors as profitable stand-alone trading solutions. All trading signals result from special interpretations of market price patterns. All geometrical Fibonacci trading devices as well as candlestick patterns and 3-point chart patterns are based on the core understanding of investor behavior expressed in peak and valley formations.

Working with our Fibonacci trading tools takes nothing more than swing highs or lows and the Fibonacci ratio (or the ratios from the PHI series). The greatest difficulty for traders is choosing correct swing highs or lows. On weekly price data, we cannot always apply Fibonacci trading tools because there are insufficient valid swings from



which to calculate turning points. On daily data, in contrast, we receive enough swing highs and swing lows, but we may get too many signals. The number of trading signals can be even greater for intraday data.

Using the Fibonacci tools in combination with candlesticks and 3-point chart patterns will not assure that we never suffer losing trades, but we can expect the majority of trades to be profitable as long as we apply the tools correctly.

Using our trading devices requires patience and discipline as well as computer skills because our WINPHI software package is essential for applying the tools. The User Manual in the Appendix instructs readers in operating the computer program.

FIBONACCI PRICE CORRECTION LEVELS

Whenever discussions among traders focus on correction levels, the Fibonacci ratios 38.2 percent, 50.0 percent, and 61.8 percent come up.

As explained in Chapters 3 and 4, we favor the correction level 61.8 percent for the risk/reward ratio as being the best compared with the alternative ratios. With this approach, however, we might miss all those trades where the market does not correct as low as 61.8 percent. Traders can solve this problem by combining the Fibonacci ratios with other trading tools such as candlesticks or regular 3-point chart patterns.

We first present trading signals generated simply with the Fibonacci ratio 61.8 percent as our initial price correction level. Then we show how the trading signals change on the same data series when we merge candlesticks and 3-point chart patterns into the strategy.

Stand-Alone Fibonacci Correction Level 61.8 Percent

In our first example, we apply Fibonacci corrections to S&P 500 Index data ranging from December 2001 to April 2002.

We use the following parameters:

- Swing size of 30 basis points; no entry rule, that is, immediate countertrend entry as soon as the correction level is reached.
- Stop-loss point at swing high (sell signals) or low (buy signals).
- Daily data; slippage and commission excluded.



Figure 6.1 and Table 6.1 show the resulting sample trading signals.

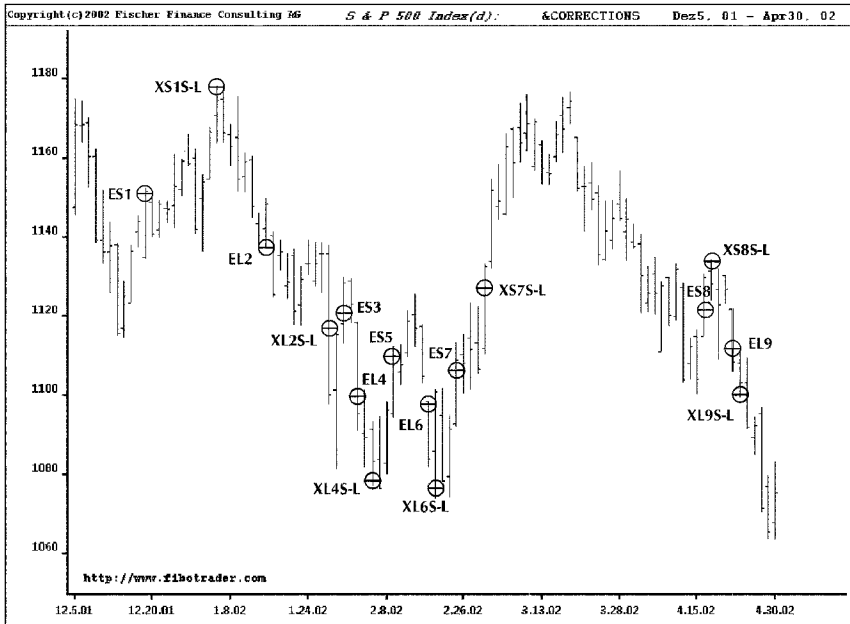

Figure 6.1 S&P 500 chart from 12–01 to 04–02. Simulation of trading signals based on plain price corrections daily (EL: entry long, ES: entry short, XL: exit long, XS: exit short, S-L: stop-loss).

Table 6.1 Trading Signals

#	Entry Rule	At	Exit Rule	At	Profit/ Loss in Points
1	Sell short	1,149.00	Stop-loss	1,174.00	(25.00)
2	Buy long	1,138.00	Stop-loss	1,115.00	(23.00)
3	Sell short	1,117.00	Buy reverse	1,099.00	18.00
4	Buy reverse	1,099.00	Stop-loss	1,081.00	(18.00)
5	Sell short	1,106.00	Buy reverse	1,097.00	9.00
6	Buy reverse	1,097.00	Stop-loss	1,076.00	(21.00)
7	Sell short	1,105.00	Stop-loss	1,125.00	(20.00)
8	Sell short	1,121.00	Stop-loss	1,133.00	(12.00)
9	Buy long	1,113.00	Stop-loss	1,100.00	(13.00)

The results of the simulation look discouraging. The main reason for the high number of losing trades is the immediate market entry any time that a 61.8 percent retracement level is reached. Our analysis shows that the probability for a trend change at the retracement level is not high enough for trading this strategy. Nevertheless, it is important to note that earlier investments at retracement levels of 50.0 percent or 38.2 percent would have worsened the picture because the stop-loss points would have been farther away from the entry levels.

To tackle the problem, we combine a Fibonacci correction level 61.8 percent and candlestick chart patterns.

Fibonacci Retracement 61.8 Percent and Candlestick Patterns

Seven sample trading signals can be found in the S&P 500 Index, again between December 2001 and April 2002 (see Figure 6.2).

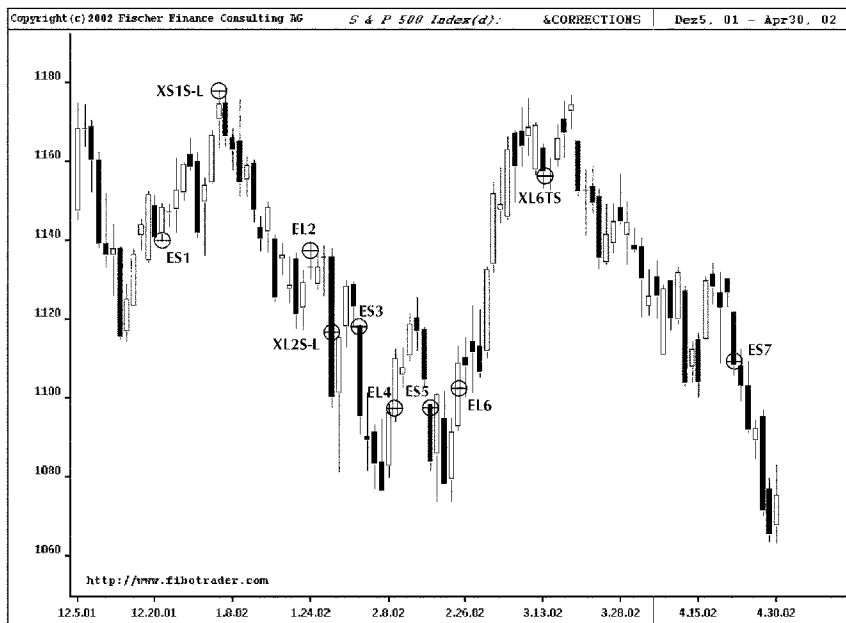

Figure 6.2 S&P 500 chart from 12–01 to 04–02. Simulation of trading signals based on plain price corrections daily in combination with candlesticks (EL: entry long, ES: entry short, XL: exit long, XS: exit short, S-L: stop-loss, TS: trailing stop).

The trading signals in Figure 6.2, as combinations of Fibonacci price corrections and candlestick chart patterns, are based on a simple set of parameters:

- Swing size of 30 basis points.
- Entry rule based on candlestick chart patterns after the Fibonacci correction level 61.8 percent is reached.
- Stop-loss point at previous swing high or low.
- 3-day high or low trailing stop.
- Daily data; slippage and commission excluded.

The profits and losses for corrections and candlesticks in combination look a bit more promising compared with the results of Fibonacci price corrections as a stand-alone strategy. All seven trades are shown in Table 6.2.

Table 6.2 Trading Signals (HA: Harami Pattern, EN: Engulfing Pattern, DC: Dark Cloud Cover, BH1: Bullish Belt-Hold, BH2: Bearish Belt-Hold, PP: Piercing Pattern, ES: Evening Star)

#	Entry Rule	At	Exit Rule	At	Profit/ Loss in Points
1	Sell short HA	1,138.00	Stop-loss	1,152.00	(14.00)
2	Buy long EN	1,137.00	Stop-loss	1,115.00	(22.00)
3	Sell short DC	1,118.00	Buy reverse	1,098.00	19.00
4	Buy reverse BH1	1,098.00	Sell reverse	1,098.00	0.00
5	Sell reverse BH2	1,098.00	Buy reverse	1,101.00	(3.00)
6	Buy reverse PP	1,101.00	Trailing stop	1,157.00	56.00
7	Sell short ES	1,109.00			Open

The main reason for the improved outcome of the simulation is the change in the entry rule from entering the market immediately on reaching the Fibonacci correction target to waiting for a candlestick pattern that confirms the trend direction.

The number of stop-losses is reduced and the total number of trades is down from nine to seven.



Another way of merging pattern recognition into price corrections as Fibonacci trading tools is to combine the 61.8 percent retracement level with 3-point chart patterns.

Fibonacci Retracement 61.8 Percent and 3-Point Chart Patterns

The biggest problem in trading corrections is to stay close enough to the fast-moving trend changes while waiting long enough for confirmation of the trend change.

Candlesticks have shown a positive effect on the total performance of the trading strategy. How far the integration of 3-point chart patterns leads to a similar effect can be estimated for the S&P 500 Index according to the trading signals in Figure 6.3.

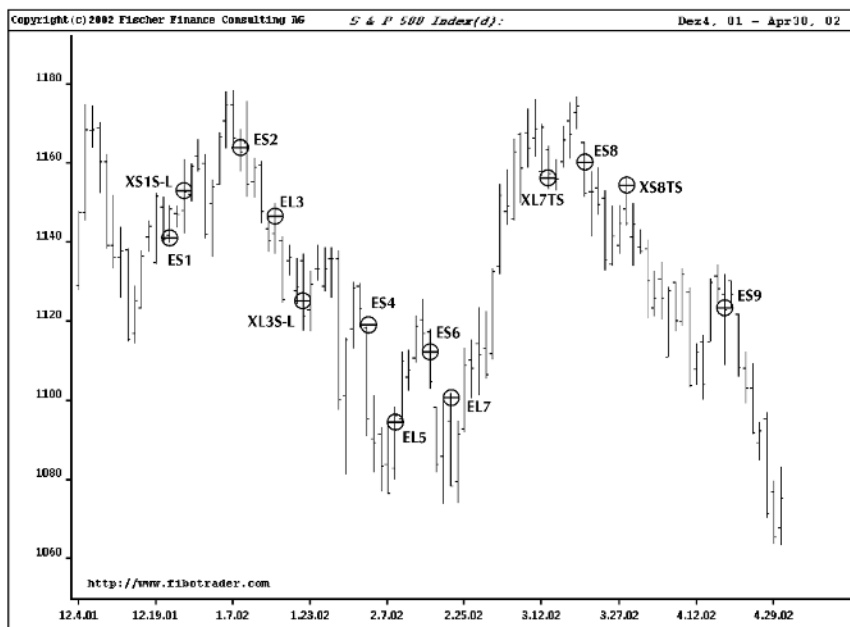

Figure 6.3 S&P 500 chart from 12–01 to 04–02. Simulation of trading signals based on plain price corrections daily in combination with 3-point chart patterns (EL: entry long, ES: entry short, XL: exit long, XS: exit short, S-L: stop-loss, TS: trailing stop).

The underlying relevant trading parameters for generating entry and exit signals are:

- Swing size of 30 basis points.
- Fibonacci correction level 61.8 percent.
- Market entry on 1-day high/low backward look after the correction level is reached.
- Stop-loss point at previous swing high or low; re-entry after being stopped out.
- 3-day high/low trailing stop.
- Daily data; slippage and commission excluded.

Nine trading signals can be found for the S&P 500 Index between December 2001 and April 2002 (as shown in Figure 6.3). They are summarized in Table 6.3.

Table 6.3 Trading Signals

#	Entry Rule	At	Exit Rule	At	Profit/ Loss in Points
1	Sell short	1,140.00	Stop-loss	1,152.00	(12.00)
2	Re-sell short	1,163.00	Buy reverse	1,146.00	17.00
3	Buy reverse	1,146.00	Stop-loss	1,124.00	(22.00)
4	Sell short	1,118.00	Buy reverse	1,094.00	24.00
5	Buy reverse	1,094.00	Sell reverse	1,112.00	18.00
6	Sell reverse	1,112.00	Buy reverse	1,101.00	11.00
7	Buy reverse	1,101.00	Trailing stop	1,156.00	55.00
8	Re-sell short	1,161.00	Trailing stop	1,153.00	8.00
9	Sell short	1,123.00			Open

Working with an entry rule and reentry rule improves the trading results to an acceptable level. The entry rule ensures that we receive a short-term confirmation of a trend change. The reentry rule



comes into effect after swing highs or swing lows are broken and the market price moves back into the trading range.

Looking back to the immediate entries on price corrections in the first example of the section (Figure 6.1 and Table 6.1), we can now re-examine the trading signals according to underlying price patterns that would have prevented us from entering the market too early:

- Signal 2 failed when the market price formed a double top.
- Signal 4 failed when the market price formed a double bottom.
- Signal 7 failed when the market price formed a triple bottom.
- Signal 8 failed based on a quadruple top.
- The low of signal 9 followed a triple top.

The integration of 3-point chart patterns and a backward look entry rule have a positive effect on the trading results in combination with Fibonacci price corrections of 61.8 percent.

The 3-point chart patterns are a stable element of trading the markets and should be watched carefully, whereas swing size and reentry rule may vary from product to product. Hardly any other investment tool can monitor the investor behavior as accurately as regular 3-point chart patterns.

Now that we have discussed the S&P 500 Futures Index on three different approaches to analyze the Fibonacci retracement level 61.8 percent, we want to add two stocks, Microsoft (member of the Dow Jones 30 Index) and Allianz (member of the Dax 30 Index).

In contrast to Microsoft, which moves in a trending pattern, Allianz is stuck in a sideward market. Not surprisingly, the number of trades is much smaller in a trending market. Microsoft shows 6 trades in 12 months, whereas Allianz comes up with 12 trades in just 6 months.

The latter finding is typical of the kind of strategy we present. Because we never know future market patterns in advance, we have to take every trade.

As discussed in Chapters 3 and 4, the most crucial parameter—in addition to the 61.8 percent retracement level—is the swing size. The swing size of a trading product can only be determined from test runs on historical data. However, conducting test runs is not difficult



and can be done by every trader. Knowing the price level a product is trading at is less important than knowing its most common swing size.

Every trading vehicle that we analyze has a different volatility. In contrast to the S&P 500 Index, which shows a trading range between less than 800 points and somewhat above 1,200 points over the past year, Microsoft trades at price levels between USD 40 and 70, and Allianz trades at price levels between EUR 230 and 290. Traders have to keep in mind that the smaller the swing size is, the more trades we get. If the swing size selected is too large, we might not get a trade at all. The easiest way to find a good swing size is to look at historical data on the longest lasting sideward pattern to find the best average swing size value.

Figure 6.4 contains the chart example of Microsoft over one year.



Figure 6.4 Microsoft chart from 11–01 to 11–02. Simulation of trading signals based on plain price corrections daily in combination with 3-point chart patterns (EL: entry long, ES: entry short, XL: exit long, XS: exit short, S-L: stop-loss, TS: trailing stop).

Figure 6.5 shows the same trading approach applied to the Allianz stock late in 2001 and early in 2002.

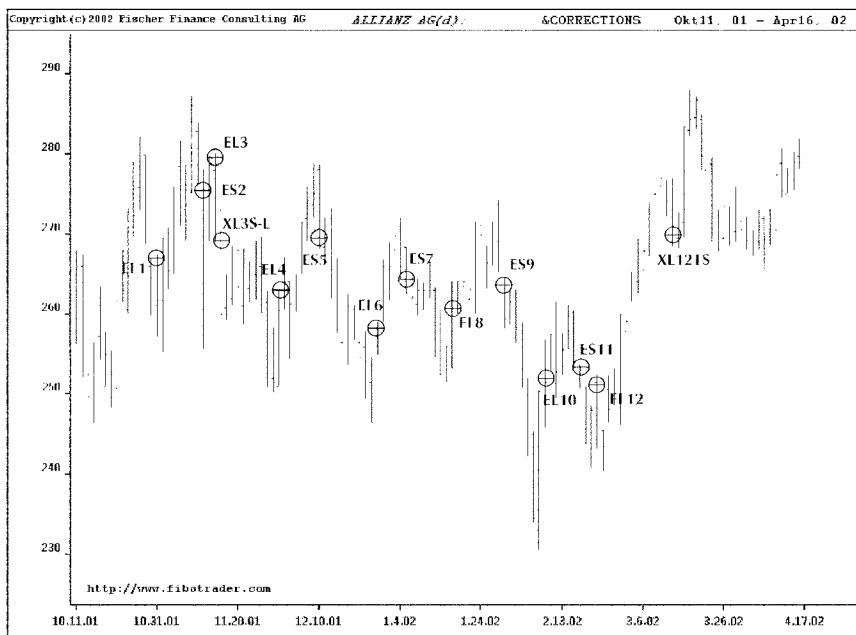

Figure 6.5 Allianz chart from 10–01 to 04–02. Simulation of trading signals based on plain price corrections daily in combination with 3-point chart patterns (EL: entry long, ES: entry short, XL: exit long, XS: exit short, S-L: stop-loss, TS: trailing stop).

Having explained in detail the Fibonacci ratio 61.8 percent in combination with candlesticks and 3-point chart patterns, it is pertinent to mention the alternative two Fibonacci-related key ratios: 38.2 percent and 50.0 percent.

Additional Fibonacci Correction Levels

Do 38.2 percent and 50.0 percent Fibonacci correction levels require different rules from the ones described thus far in this chapter? This question is important because nothing is more frustrating for a trader than to wait for the Fibonacci retracement level 61.8 percent, and then shortly before it is reached, to have the market turn with no trade done.

The dilemma of making the right decision at the right time based on Fibonacci price corrections becomes obvious when we look at the Dax 30 Index in Figure 6.6.

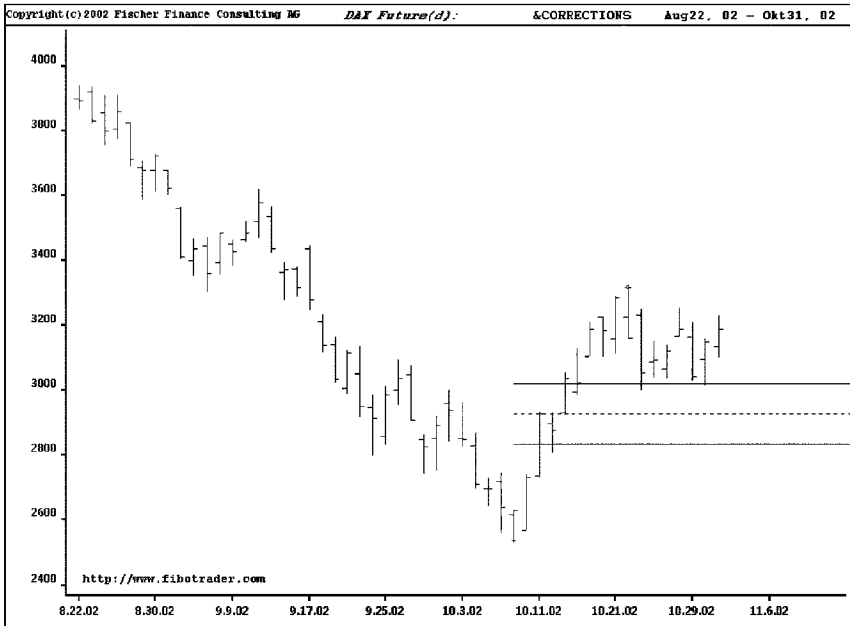

Figure 6.6 Dax 30 chart from 08-02 to 10-02. Fibonacci correction levels.

A strong rally is followed by a price correction to the first Fibonacci retracement level of 38.2 percent. At this point—when almost all information services, market letters, and media representatives call for new lows—the trader must decide whether to wait for the 61.8 percent retracement level or to risk executing a long trade in the Dax 30.

What we need and are trying to find here is additional support that makes the decision a little easier. A tool that could help us consider the final strength of the price correction would be ideal.

One tool that has proven reliable already when used in combination with the 61.8 percent Fibonacci correction level is candlestick charting. If we change the charting technique and add candlesticks to

the chart of the Dax 30 Index, we see a clear picture that makes our decision convincing and valid (see Figure 6.7).



Figure 6.7 Dax 30 chart from 08–02 to 10–02. Fibonacci correction levels and candlesticks.

From the chart, we can draw the following rules for a solid short-term long trade in the Dax 30 index:

- The Fibonacci Level 38.2 percent is reached.
- After the correction level is reached, we identify a doji candlestick pattern, which is a strong indication that the market price will at least not drop further from this price level. The following day, we identify an engulfing candlestick pattern that confirms the market price is ready for a correction.
- To receive still more confirmation of the potential trend reversal to the upside, we can wait two more days; the market price forms a double bottom.

At the latest on the fifth day after the price movement touching the 38.2 percent retracement line, a harami pattern assures us of a possible market entry long at controlled risk. We set the stop-loss at the low of the day that breaks the 38.2 percent correction line.

A similar simulation can be conducted for the 50.0 percent retracement level, which is also well recognized by traders. For traders who plan to keep stocks longer in a portfolio, this is a decent correction level, especially because it is reached much more often than the conservative 61.8 percent Fibonacci retracement level.

Figure 6.8 shows a chart of the S&P 500 Index between May and September 2002.



Figure 6.8 S&P 500 chart from 05–02 to 09–02. Correction levels.

Once again, we are caught in a situation where waiting for the 61.8 percent correction level might lead to a dead end with no trade at all. Using plain correction levels without additional indicators has little value, especially for traders with a short-term orientation. As before, this is where candlestick pattern recognition becomes part of the game.

Integrating the candlestick charting technique into the general picture of Fibonacci price corrections changes the S&P 500 Index chart, as shown in Figure 6.9.



Figure 6.9 S&P 500 chart from 05–02 to 09–02. Correction levels in combination with candlesticks.

The candlestick pattern analysis runs as follows for a long signal in the S&P 500 Index once the price move breaks the 50.0 percent retracement line:

- The harami candlestick pattern is a first indication that the market correction might not continue.
- The harami pattern is followed by a hammer candlestick pattern. The hammer is a very strong confirmation that a trend change to the upside is about to occur.
- Finally, and in addition to the candlestick patterns, the resistance line is significantly broken to the upside.

We get a buy signal at the high of the day with the hammer candlestick pattern and on the breakout of the resistance line. The most recent valley before the long entry determines the stop-loss.

Instead of combining Fibonacci price corrections with candlestick patterns or 3-point chart patterns, traders can also merge them with Fibonacci extensions, support and resistance lines, and PHI-ellipses in an integrated Fibonacci-related approach.

Fibonacci Corrections and Multiple Fibonacci Tools

Trading signals based on Fibonacci corrections become more valid as more tools confirm a turning point in the market. All Fibonacci trading tools are devices for reflecting investor behavior. That is why it is easy to combine them.

We are looking for clusters of confirmations of trend reversals. To get the full picture, we add Fibonacci extension levels as well as support and resistance lines to our starting trading device, the Fibonacci price corrections.

The three main Fibonacci retracements 38.2 percent, 50.0 percent, and 61.8 percent are nothing more than the converted Fibonacci ratios 0.618, 1.000, and 1.618. When looking for trend changes, we can combine the calculations if the necessary swing sizes exist (see Figure 6.10).

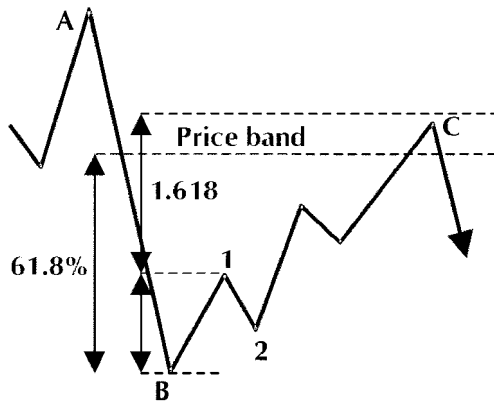

Figure 6.10 Price band based on Fibonacci correction and Fibonacci extension combined.

Many combinations of Fibonacci price corrections and extensions are possible. The rationale behind the calculation of the target prices that determine the price band is the following:

- The correction level calculated using the Fibonacci ratio 61.8 percent is reached just below point C. If we take the distance between point B and point 1 and multiply it by the Fibonacci ratio 1.618, we reach a price target that is a little bit above point C.
- The precalculated price targets often do not overlap completely. As long as the price band formed by the target prices is very narrow, we find an ideal Fibonacci target level, for the price target is calculated twice by the Fibonacci figures 1.618 and 61.8 percent.

Figure 6.11 is a bar chart example of the S&P 500 Index between November 2001 and November 2002 that combines Fibonacci price corrections and extensions.

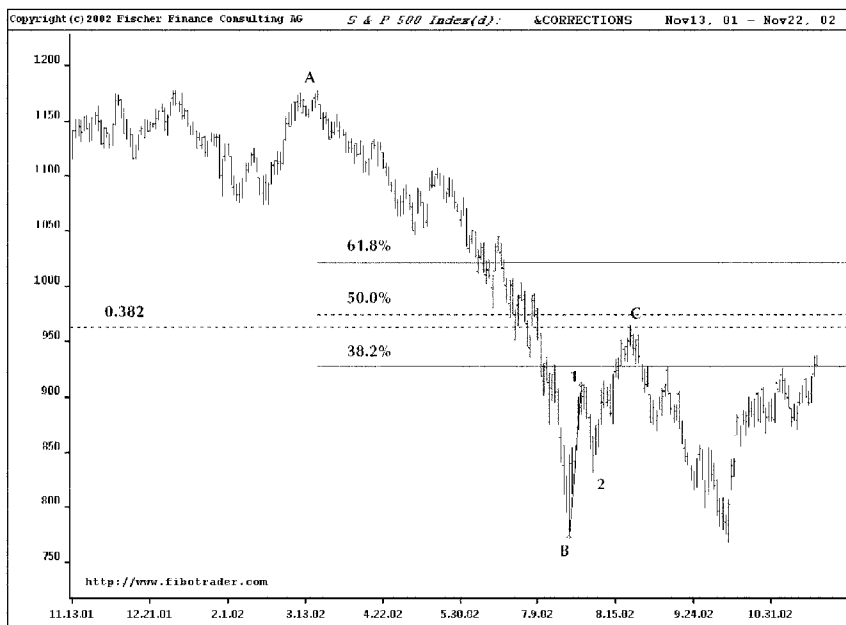

Figure 6.11 S&P 500 chart from 11-01 to 11-02. Calculation of price band.

Traders often ask whether they can predict price movements with the Fibonacci ratio. The answer is that we cannot say in advance whether a precalculated price target will ever be reached. But what we can say is that as soon as a price target precalculated by the combined Fibonacci figures is reached, the chances for a trend change are high.

Although the best price targets are those at which the Fibonacci levels 1.618 and 61.8 percent overlap, these perfect targets are rare. Fibonacci extensions are calculated using the ratios from the PHI series: 0.382, 0.618, 1.000, 1.618, 2.618, and so on. If we calculate large enough swing sizes, smaller ratios for calculating Fibonacci extensions become more important in combination with Fibonacci price corrections.

If we take the latter argument into account, the analysis shown in Figure 6.11 on the S&P 500 Index becomes easier to understand. In our example, we have applied the ratio 0.382, instead of 1.618. The price band on the chart, therefore, is based on the following calculations:

- The Fibonacci correction level of 50 percent between point A and point B leads to a target price of 975.00 points in the S&P 500 Index.
- The Fibonacci extension level of 0.382 leads to a target price of 963.00 points in the S&P 500 Index.

Because we focus on large swings that last over months, we cannot expect to find price targets calculated at ratios of 1.618 (extension) or 61.8 percent (correction) to be easily reached.

In our example, we have calculated the first wave of a long-term S&P 500 Index market movement. If it holds true that we have finished the first and second wave of a 3-wave price pattern, the S&P 500 Index is currently in the third wave. The next price target is the high of wave one at 966.00.

If the market price moves continuously higher, the correction levels of 50.0 percent and 61.8 percent become critical price targets that traders should watch carefully. In the event of further rising prices, new price extension levels based on swings that have not yet been realized may be used for additional calculations.

Whenever Fibonacci price correction levels of 50.0 percent or 61.8 percent are reached on large swings, we might not enter the



market right away based on daily price data (and use a sophisticated entry rule instead). For short-term traders, however, especially those with an intraday perspective, these price goals are extremely important (see Figure 6.12).

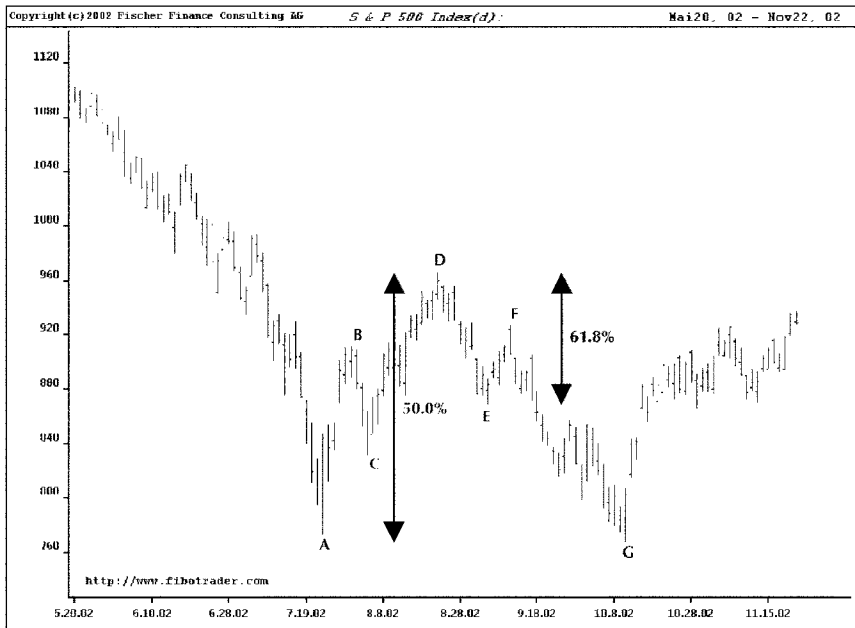

Figure 6.12 S&P 500 chart from 05-02 to 11-02. Short-term turning points.

Thus far in this chapter, we have encouraged readers to wait for additional confirmations of trend reversals once Fibonacci correction levels have been triggered by candlestick patterns, 3-point chart patterns, or other Fibonacci devices. Short-term traders, however, who only want to scalp a few basis points at very low risk, need to pay attention to the following price targets:

- At point E, the total distance from points A to D is corrected by 50.0 percent, followed by a strong price move in the S&P 500 Index.
- At point F, the total distance from points D to E is corrected by 61.8 percent. The market price in the S&P 500 Index reverses instantly to the downside at point F.

If we switch the perspective after this intermezzo from short-term back to long-term, we finally set the focus to profitable combinations of Fibonacci price corrections, Fibonacci extensions, and PHI-ellipses.

Figure 6.13 shows a perfect buy signal for a long-term investment immediately after the lowest low in the S&P 500 Index is made late in September 2002.

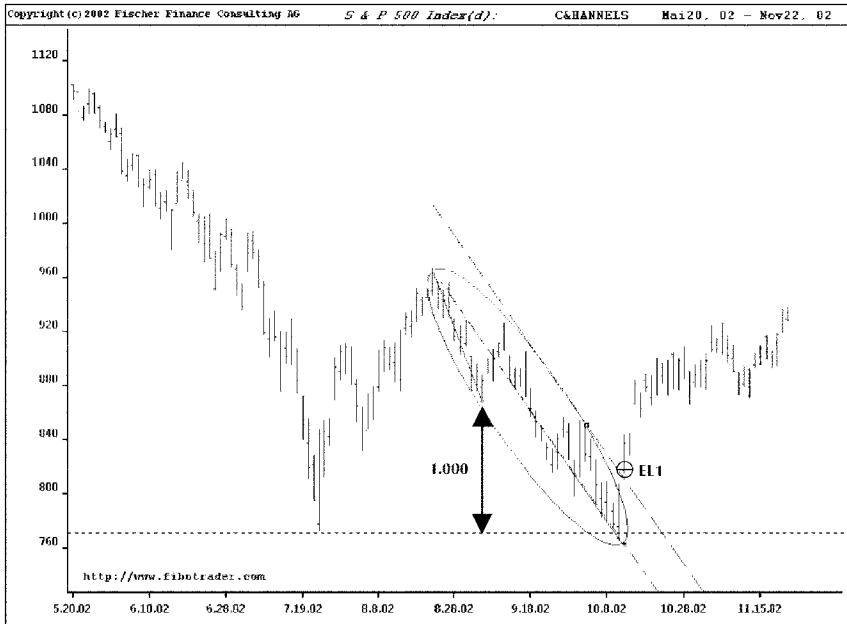

Figure 6.13 S&P 500 chart from 05–02 to 11–02. Long-term turning points.

New lows or highs (especially in large swings and double bottom or double top formations) are always possible indications of major trend reversals. Investors should be highly alert for a trend change if other tools and parameters confirm the turning point.

The price extension in Figure 6.13, calculated as the total distance from the high at 965.00 to the low at 868.00 multiplied by the Fibonacci ratio 1.000, leads to a target price of 772.00. The lowest low in the S&P 500 Index is at 775.00. One can hardly get closer. (The lowest low in the range from 750.00 to 800.00 in the S&P 500 Index could have been calculated many months earlier, based on other price swings. We come back to this in the next section.)

Once the double bottom is made, our entry rule applies. The breakout of the outside line of the PHI-ellipse confirms the trend reversal. The buy signal is filled market on open on the day of the breakout.

Summary

Trading the Fibonacci correction levels 38.2 percent, 50.0 percent, and 61.8 percent successfully depends on several factors. The biggest question is the swing size a trader is working with. If the swing size is large, the correction level 38.2 percent might be appropriate.

However, if the swing size is too large, we might get a trade only once or twice a year. If the swing size is too small, we might get too many trading signals. The easiest way to find a good swing size on the products we want to trade is to look at sideward markets on historical data. The profitability of the approach also depends on whether we work with daily or intraday data.

For daily data, we recommend trading the 61.8 percent correction level if a trader has the patience to wait for this level to be reached. However, as our examples on S&P 500 Index data indicate, there might be times when looking for the correction levels is not good enough. What is needed is also an entry rule to confirm the trend change. In addition, it is always important to work with a stop-loss.

The integration of candlestick charting significantly improves the results. On the other hand, candlesticks suffer the disadvantage that we do not always find a valid candlestick pattern when our favorite retracement level is triggered (meaning that we miss trades).

The best trading strategy while working with 61.8 percent correction levels is a combination of entry rule and 3-point chart patterns, as demonstrated in our examples. The 3-point chart patterns are always there and are always reliable. The chart examples on Microsoft and Allianz are proof that this approach can be easily applied to stocks or any other product with a trending market pattern and enough volatility at a good swing size.

The biggest problem for a trader is to wait for the 61.8 percent correction level; the market price comes close but does not reach it, and then moves in the opposite direction. The trader has anticipated the price correction properly, but misses a big profit opportunity, because of working with a 61.8 percent correction level. To solve this



problem, we have combined different correction levels with candlestick patterns and 3-point chart patterns in our examples. Combining Fibonacci price extensions and corrections can be of great help for a trader who is looking for solid entry levels.

Long-term and short-term calculations based on price corrections, finally, can be combined with price extensions, 3-point chart patterns, and PHI-ellipses. Combinations of the three seldom show up. As discussed, it takes a lot of discipline to wait for such combinations, and it is an even bigger problem to execute the trading signals when they show up. Inexperienced investors often are afraid to take countertrend signals. To make investment decisions easier and more reliable, we look for multiple confirmations of trend reversals.

FIBONACCI PRICE EXTENSIONS

In general, extensions mean investments against the main trend, which is defined by the first impulse swing in a 3-wave move or a 5-wave pattern. Extensions are important as Fibonacci trading tools because they show up not only in fast moves over a couple of days or weeks in soft commodities, but also in financial instruments, derivatives, or currencies as indicators of major trend changes.

Extensions occur at extreme points when media coverage sets investors on fire. Traders must be patient and disciplined because extensions are patterns that can rarely be detected in the markets. As stated, markets are in a trending state less than one third of the time. Therefore, we receive many more signals on the basis of corrections than extensions.

Generally speaking, extensions are defined on the basis of a 3-wave pattern. A target price is calculated from the initial swing size of the first impulse wave, multiplied by the Fibonacci ratio 1.618 (or the alternative ratios 0.382, 0.618, 1.000), and the resulting product, once again, added to the swing size.

In this section, however, we are not so much interested in extensions as trading tools to generate countertrend trading signals once the price target is reached. What we want to deal with are the price targets at the end of Fibonacci extensions because they are highly significant indicators of points in the market action where trend changes are likely.



Whereas working with Fibonacci corrections means having a high and a low point and looking for possible correction levels in price, working with extensions means the opposite. We have a price swing from point A to point B as described in the previous section and want to know how far the market price might go before it runs into resistance levels.

Calculating Price Targets

Inexperienced Fibonacci traders may find these calculations confusing; the purpose of the chart provided in Figure 6.14 is to prevent readers from getting lost in the jungle of corrections and extensions. The chart shows the S&P 500 Index between May and November 2002.

The swing from point A to point B is the basis for our calculation. We calculate the three price targets for extensions by using the ratios

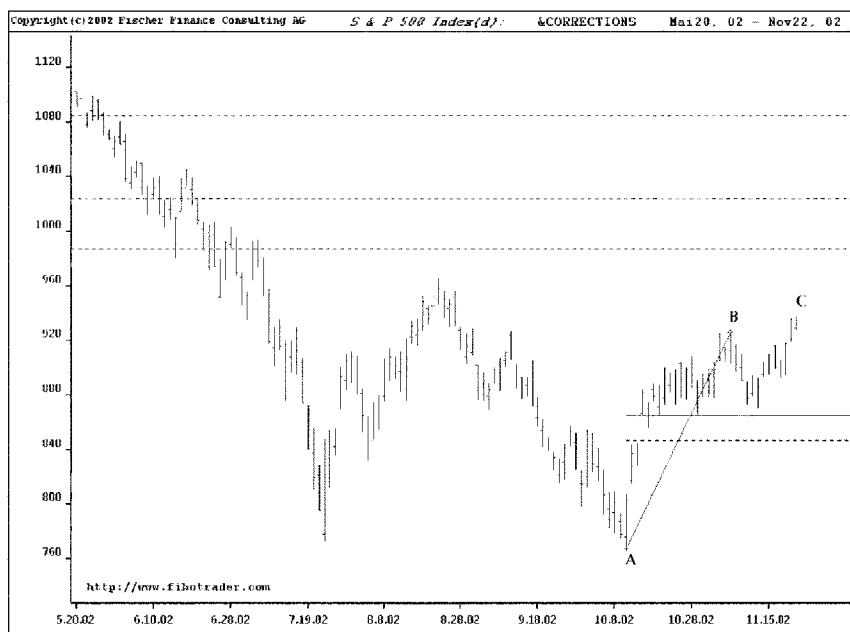

Figure 6.14 S&P 500 chart from 05–02 to 11–02. Price targets.

0.618, 1.000, and 1.618. Figure 6.14 also shows the three corresponding price targets for market corrections at levels of 38.2 percent, 50.0 percent, and 61.8 percent.

If the market does not go higher than the high in point C and makes a new peak there, we have to recalculate our price targets up and down based on the new initial swing from point A to point C.

Our main aim is to find price clusters, or multiple confirmations of price targets, at which major trend reversals can be expected. The following three-step approach in the S&P 500 Index between July 2001 and November 2002 starts with the extension levels, continues with the correction levels and, finally, brings them both together to come up with price bands formed by price extensions and price corrections.

Figure 6.15 contains three important price extension levels in the S&P 500 Index, calculated at Fibonacci ratios 0.382, 1.618, and 1.000 based on the initial swing from points B to C.

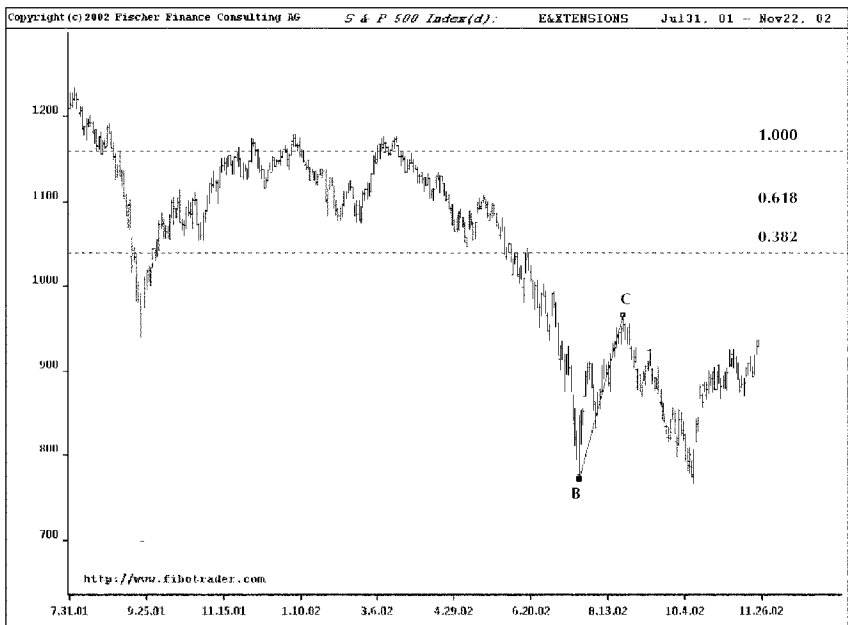

Figure 6.15 S&P 500 chart from 07-01 to 11-02. Extension levels.

The swing from the valley at point B to the peak at point C is a corrective move to the strong downtrend starting in March 2002. We can draw three Fibonacci corrections at levels of 38.2 percent, 50.0 percent, and 61.8 percent on the chart of the S&P 500 Index, again between July 2001 and November 2002. The initial price swing this time runs from the peak in A to the valley in B (see Figure 6.16).

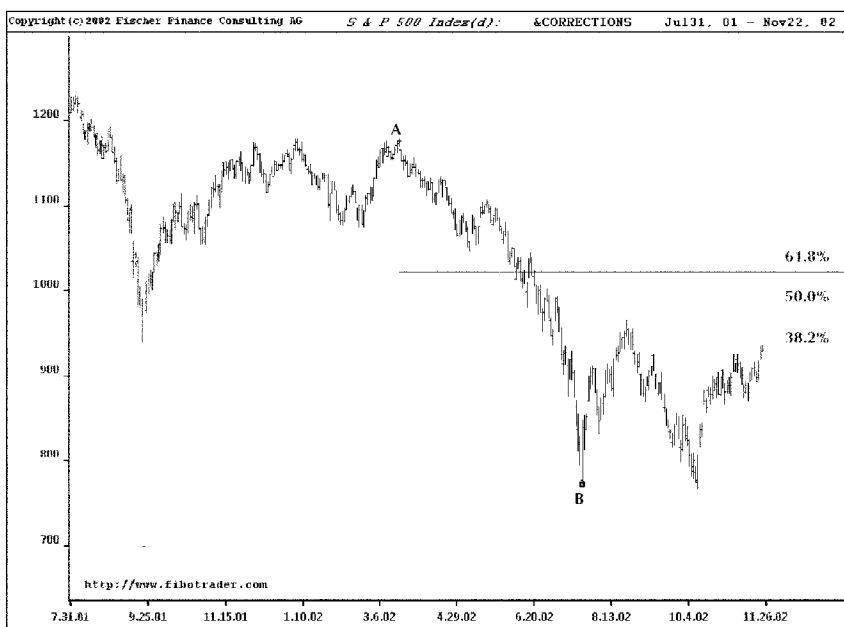

Figure 6.16 S&P 500 chart from 05-02 to 11-02. Correction levels.

The reason we conduct the analysis is to get to areas of support and resistance that are projections from today into the future.

Our final step is to bring Fibonacci extensions and Fibonacci price corrections together in one chart, thereby defining price bands that are areas of potential major trend reversals.

The chart combining the different price targets of the S&P 500 Index was completed late in November 2002, shortly before we finished the first draft of this book. We did not, of course, know what the market price would do. However, we knew that the extension levels presented here would be important.

We could not know whether and when the price targets would be reached, but if the market price in the S&P 500 Index were to go to any of these price bands, it would find resistance. How much resistance? We did not know that, either, but readers who have worked their way through this book up to this point know the tools and how to handle them properly for a solid market analysis.

Figure 6.17 shows the three resistance areas in the S&P 500 Index derived from the combination of Fibonacci extensions and corrections.

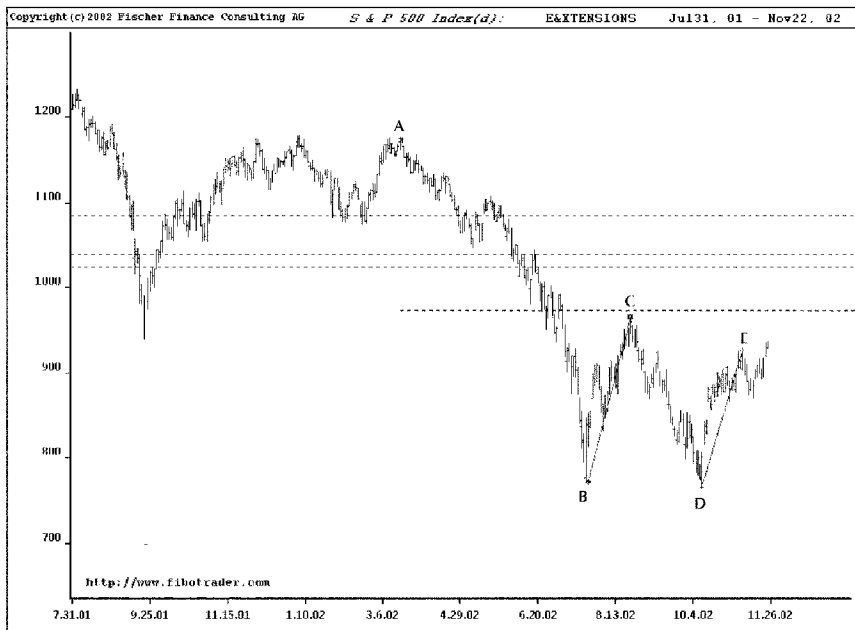

Figure 6.17 S&P 500 chart from 05–02 to 11–02. Resistance areas based on Fibonacci extensions and corrections.

The three resistance areas can be analyzed as follows:

1. The first resistance area is between 963.00 and 974.00 points. The calculation is based on the correction level of 50.0 percent measured from the initial swing from the peak at point A to the valley at point B, and on the Fibonacci price extension calculated at a ratio 0.382 on the swing size from point D to point E.

مرجع آموزش بورس

2. The second resistance area is between 1,022.00 and 1,038.00 points. This price band is calculated based on the Fibonacci correction level 61.8 percent (points A to B), an extension at a ratio 0.382 (valley in B to peak in C), and a second price extension at a ratio 0.618 (valley in D to peak in E).
3. A third resistance level shows up at about 1,085.00 points. This can hardly be called an area, because two extensions, one calculated at a ratio 0.618 on the swing from B to C, and one calculated at a ratio 1.000 on the swing from D to E both lead to almost the same target price in the S&P 500 Index.

It is important to realize that Fibonacci extensions and corrections point at trend reversals in price, not in time. An experience we had with one of our projections for the S&P 500 Index illustrates the importance of time as a trading factor.

A True Story

In the investment magazine, *Hedge Funds Review*, 13, October 2001 (p. 18), we published an article under the working title “How Far Will the S&P 500 Index Drop?”

Our calculated target price was between 750.00 and 800.00 points. We were on the dollar with our calculation pricewise, but we did not expect the S&P 500 Index first to go up and then reach our price target. We described as well how we would get a buy signal based on a PHI-ellipse should the market price not go lower but climb higher instead.

This example reflects real life and shows exactly the dilemma while working with Fibonacci price targets: Calculations might be correct, but timing may be off. Nothing in this universe can calculate trend changes in price and time correctly all the time. But Fibonacci calculations have an astonishing rate of accurate forecasting in price—if the time factor is briefly faded out.

Long-Term Trend Changes in the Japanese Yen Cash Currency

In contrast to the previous projection to define future resistance areas of the S&P 500 Index, the following chart example shows trend changes in the Japanese Yen cash currency.



Our historical daily data sample covers February 2001 to November 2002. Five major trend reversals based on price extensions can be pinpointed for the 20 months, according to Figure 6.18.

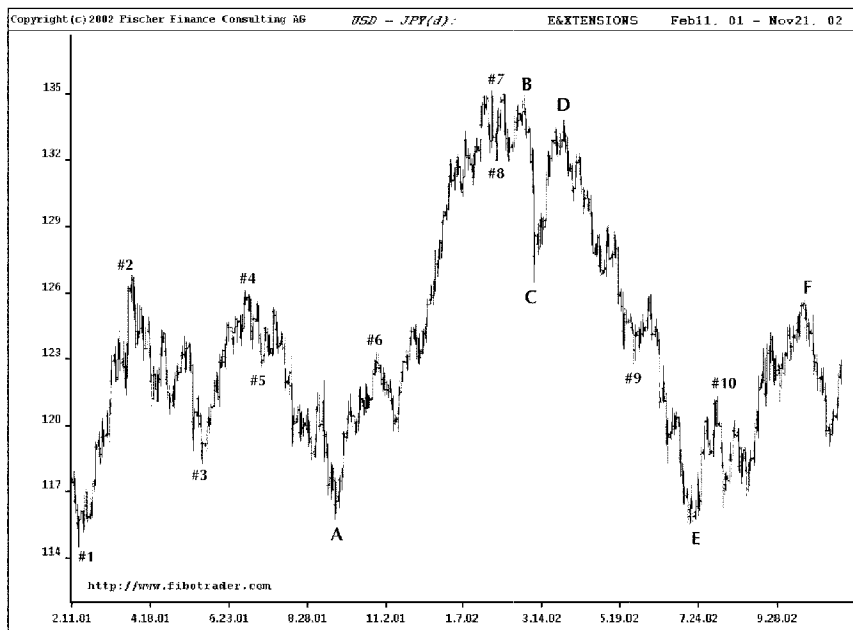

Figure 6.18 Japanese Yen chart from 02-01 to 11-02. Major trend changes.

The significant trend reversals in the Japanese Yen cash currency are marked A to F. The calculations of price targets to confirm the trend changes run as follows:

- The price band for the trend change at point A is calculated by multiplying the distance from point 2 to point 3 by the Fibonacci ratio 0.618, and by multiplying the distance from point 4 to point 5 by the ratio 1.618.
- The price band for the trend change at point B is calculated by multiplying the distance from point 1 to point 2 by the ratio

0.618, and by multiplying the distance from point A to point 6 by the ratio 1.618.

- The price band for the trend change at point C is calculated by multiplying the distance from point 7 to point 8 by the ratio 1.618, and by making use of the support level formed by the significant peaks at points 2 and 4.
- The price band for the trend change at point E is calculated by multiplying the distance from point B to point C by the ratio 1.000, and by multiplying the distance from point D to point 9 by the ratio 0.618.
- The price band for the trend change at point F is calculated by multiplying the distance from point E to point 10 by the ratio 0.618, and by a 50.0 percent retracement measured on the swing from the peak at point 7 to the valley at point E.
- The tools applied do not identify the trend change in D. There is no price band to capture the trend reversal at point D.

Summary

Working with Fibonacci price extensions can be important to calculate long-term or short-term turning points in any traded product.

We have presented examples for determining price bands as targets for market movements. To define the upper and the lower border of a price band and thereby separate the important price targets from the less important ones, we use:

- Fibonacci price extensions calculated from different swing sizes.
- Fibonacci price extensions in combination with Fibonacci price corrections.

Price bands, or clusters, are those significant areas on the price scale where price targets calculated from different swing sizes either overlap or are very close together. Price clusters are especially meaningful when conducting projections of future price movements as exemplified on the S&P 500 Index. The Japanese Yen cash currency example shows how major turning points in the markets can be identified successfully on highly volatile products.



SUPPORT AND RESISTANCE LINES

Fibonacci corrections and extensions are profitable stand-alone trading solutions and are even more profitable when combined with each other.

In this section, we want to add support and resistance lines. If we believe that chart patterns reflect investor behavior, it is reasonable to attach high importance to peak/valley configurations, especially for drawing support and resistance lines.

Support and Resistance Lines Combined with Fibonacci Extensions

In the previous sections, we discussed approaches to calculating valid turning points in the markets by combining Fibonacci corrections and extensions.

In Figure 6.19, we show support and resistance lines in combination with price extensions on an S&P 500 Index sample. The extension levels are the same as the ones shown in Figure 6.15.

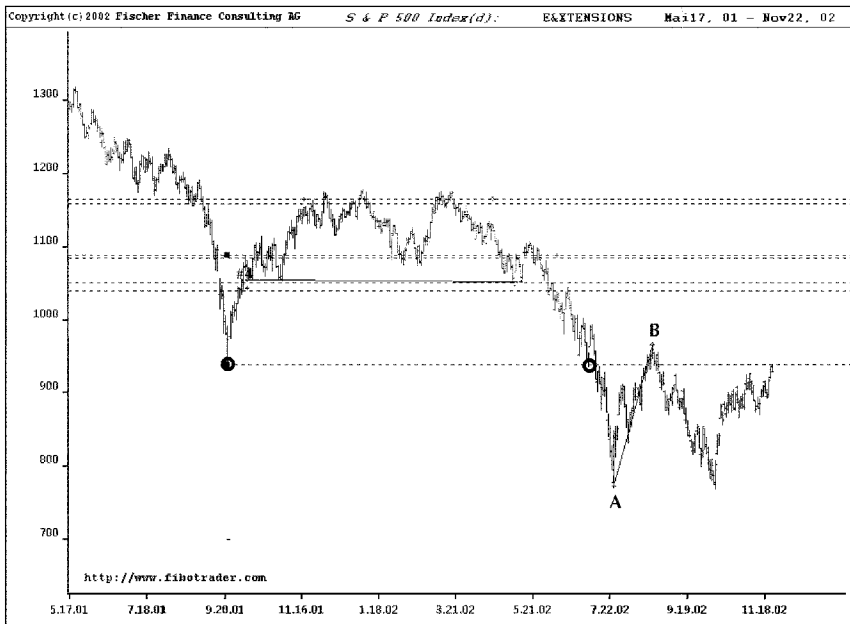

Figure 6.19 S&P 500 chart from 05–01 to 11–02. Support/resistance lines in combination with Fibonacci extensions.

Combining support and resistance lines with Fibonacci extensions maps the S&P 500 Index well and provides useful information on where the market will find resistance levels in the future.

Five price targets and clusters show up: first, a price target at 938.00 points in the S&P 500 Index; second, a target band between 963.00 and 974.00 points; third, a price band from 1,022.00 to 1,052.00 points; fourth, a price band from 1,085.00 to 1,088.00 points; and finally, a cluster between 1,158.00 and 1,166.00 points.

Again, we do not know what the S&P 500 Index will do in the near future and whether some of the precalculated price levels will ever be reached. We are only saying that if one of these levels is reached, market pricing might have difficulty moving through it without any correction.

Support and Resistance Lines Identifying Trend Changes

In addition to projecting price targets as shown on the S&P 500 Index, it is interesting to analyze how important support and resistance lines are as trading tools and whether they give enough information to identify trend reversals in selected products.

To explain what we are looking for, we start with some graphs that explain the concept, which is based on the notion that markets rotate (see Figure 6.20). The typical pattern is that support lines become resistance lines and resistance lines become support lines.

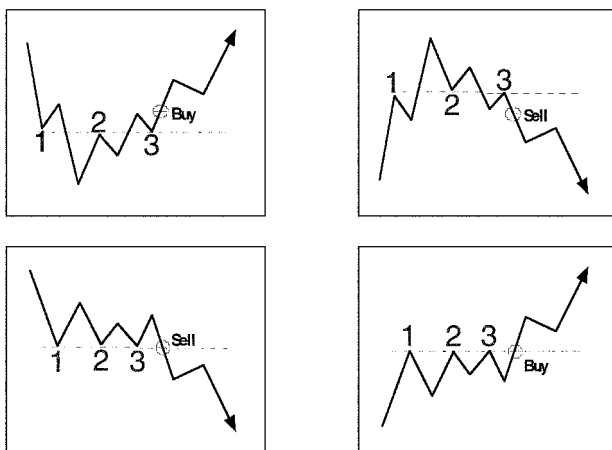

Figure 6.20 Basic support/resistance patterns.

In our analysis, we refer back to the very beginning of the book, where we explained why we are looking for the magic number three in our analysis of trend changes.

The four little graphics with basic support and resistance patterns in Figure 6.20 have the following meanings:

- We only look for support or resistance lines that are horizontal connections of peaks and valleys.
- A peak is valid if it has lower highs on either side of the highest high; a valley is valid if we find higher lows on either side of the lowest low.
- For a long trend change (see top left graph in Figure 6.20), we first need a valley and a peak to determine the trend line. We then need a second peak above the trend line to be broken to confirm the trend change.
- For a short trend change (see top right graph in Figure 6.20), we first need a peak and a valley to determine the trend line. We then need a second valley below the trend line to be broken to confirm the trend change.
- For a trend reversal to the downside (see bottom left graph in Figure 6.20), three valleys touching the support line need to be broken.
- For a trend change to the upside (see bottom right graph in Figure 6.20), three peaks touching the resistance line need to be broken.

Figures 6.21 to 6.23 provide chart examples of the S&P 500 Index, the Nasdaq 100 Index, and the Dax 30 Index. All three charts contain support and resistance lines drawn according to the principles previously described. These support and resistance lines define profitable market entries at major turning points.

Combining support and resistance lines with Fibonacci extensions to identify price clusters is safer than working only with Fibonacci ratios.



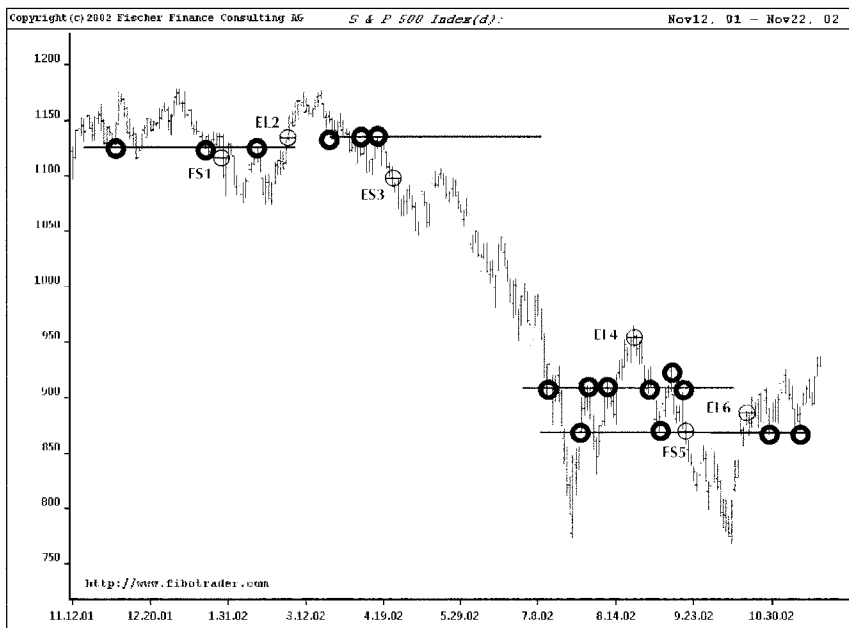

Figure 6.21 S&P 500 chart from 11-01 to 11-02. Trend changes based on support and resistance lines.

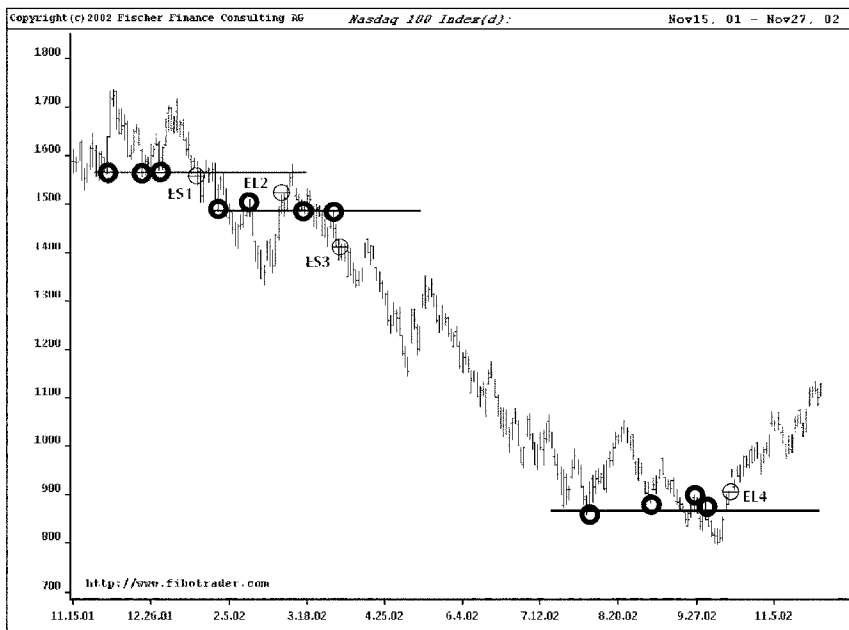

Figure 6.22 Nasdaq 100 chart from 11-01 to 11-02. Trend changes based on support and resistance lines.



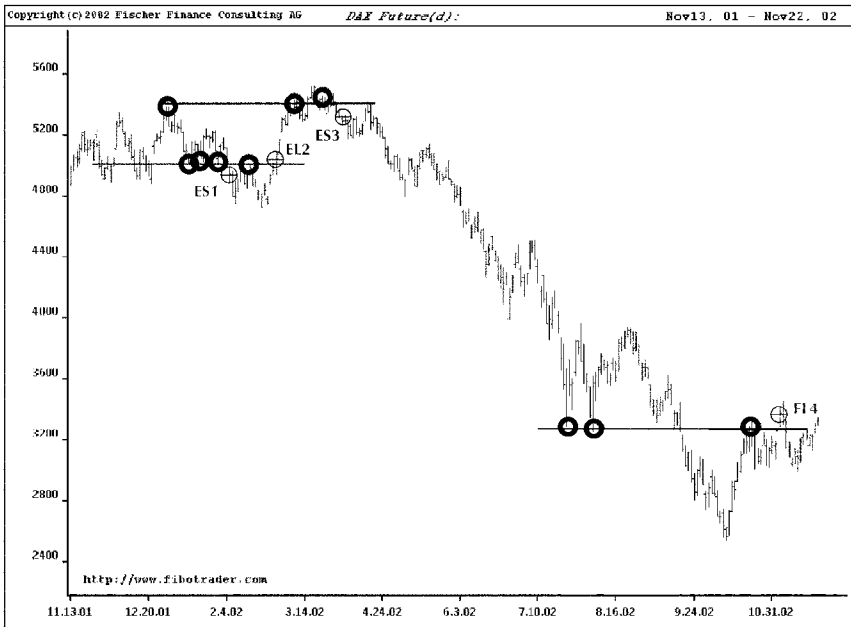

Figure 6.23 Dax 30 chart from 11-01 to 11-02. Trend changes based on support and resistance lines.

If we combine the results generated by using the Fibonacci ratios with the price levels retrieved from the support or resistance lines, the overlapping price targets are astonishing. Whereas the resistance and support lines are based on peaks and valleys way back in the past, the price targets calculated with the Fibonacci ratios are projections into the future.

The test runs shown on the three chart examples are performed on a very short period of time and can only suggest how well the concept may work in future trading. This simple concept, based on support and resistance lines and peaks and valleys, will perform well on any product without optimization as long as there are volatile and trending markets.

Support and Resistance Lines as Profit Targets

Support and resistance lines are reliable indicators of trend changes, so why not use them to determine secure profit target levels? If the trading signal results from a breakout of the resistance line or the support of a trend channel, doubling the size of the previous price band gives a good price target. This profit target rule was applied throughout Chapter 4 when discussing 3-point chart patterns (see Figure 4.30d for a recap).

The width of a trend channel is the distance from resistance line to support line of the channel. If the trading signal is generated countertrend at the support line of a trend channel, the resistance line can be the first profit target. The second profit target is twice the width of the trend channel (vice versa for countertrend trading signals at the resistance line of a trend channel).

The rest of this section explains options that traders have for taking profits. We concentrate on support and resistance lines and/or trend channel lines because these lines have proven reliable.

Furthermore, we stick with the concept of using the magic three peaks or valleys in 3-point chart patterns. Three points are the only requirements to trade successfully—as long as traders have the patience and the discipline to follow the entry and exit rules based on this principle.

To cover different markets and trading situations, we have selected five examples that are typical of different market segments. Among the five sample products are three stocks (IBM, Deutsche Telekom, Intel), one cash currency (Japanese Yen), and a stock index future (Dax 30 Index). They all can be analyzed in a similar manner.

IBM Sample Trade

Our first chart example is IBM. We show the breakout, out of a rectangle. Once we have entered the market, it is important to predefine a point at which the position is to be closed. In the end, we are looking for two exit levels, one in negative territory and one in positive territory.

Our entry rule, based on the rectangle, is filled at a price level of 74.30 USD. If we double the width of the rectangle, this simple rule leads to a profit target level of 82.50 USD.



Figure 6.24 shows the IBM trade for entry rule, stop-loss rule, and profit target rule based on a resistance line in double-width distance from the rectangle.

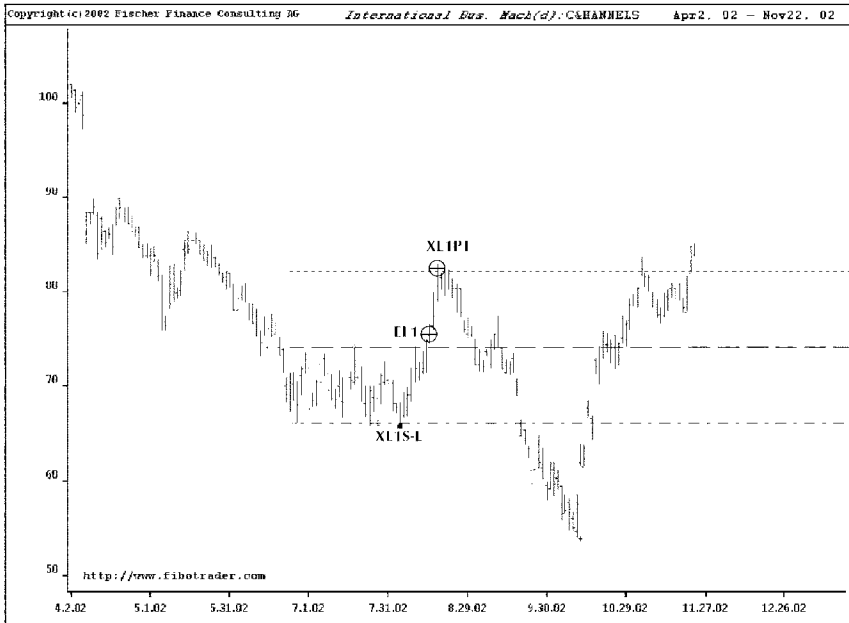

Figure 6.24 IBM chart from 04–02 to 11–02. Sample trade.

The sample trade makes our trading approach clear. We are looking for safe entry signals with a profit target that has a high probability of being reached. A rectangle as shown on the chart is a common 3-point pattern and is easy to recognize.

Deutsche Telekom Sample Trade

Figure 6.25 deals with the German large-cap stock Deutsche Telekom. When the descending triangle is broken at 9.80 EUR, the resistance line at 13.00 EUR defines the profit target. The resistance line runs parallel to the support line at 8.25 EUR. The short-term trader closes

the position and takes a profit at 13.00 EUR. This represents a profit of about 30 percent in a short period of time.

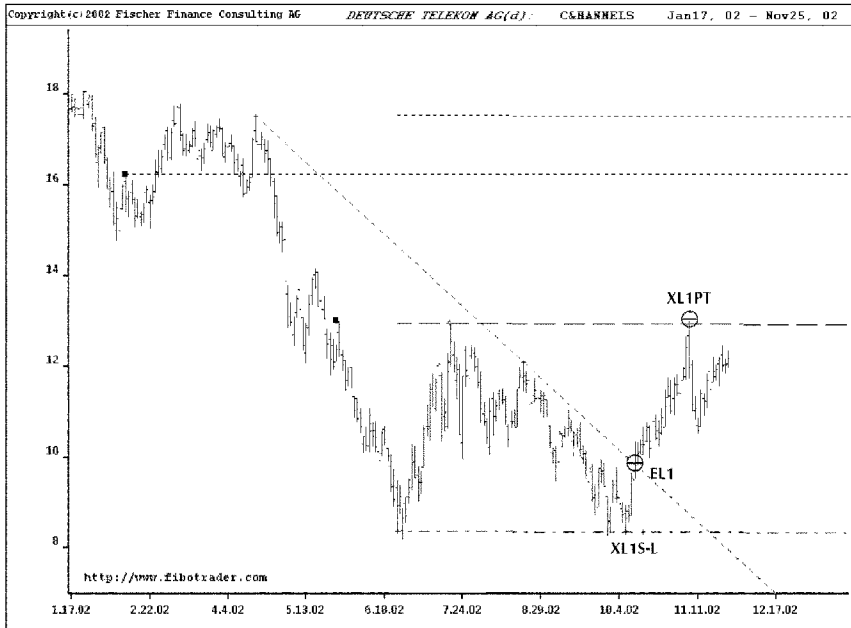

Figure 6.25 Deutsche Telekom chart from 01-02 to 11-02. Sample trade.

If we double the distance from the significant high on the triangle line in August 2002 to the lowest low of the descending triangle in October 2002, the next important profit target can be precalculated at a level of 17.55 EUR.

It is interesting to observe that the profit target resistance line at 17.55 EUR is almost identical with the two significant peaks that were formed between February and April 2002.

However, we can also draw a resistance line at 16.25 EUR, based on the peaks and valleys in January and April 2002. Which of the two resistance lines is the correct one, future price action will show. Most likely, market pricing will come up with a trading range between the two resistance lines.

Intel Sample Trade

In our third chart example, Intel, we start with a sell signal out of a rectangle that is broken to the downside, as shown in Figure 6.26. The profit target at twice the width of the rectangle is also the lowest low of the downtrend.

Two buy signals are possible. The first buy signal can be generated at a price level of 15.15 USD when the resistance line of the descending triangle is broken. The second buy signal stems from the peak that penetrates the resistance line of the rectangle at the price of 16.40 USD.

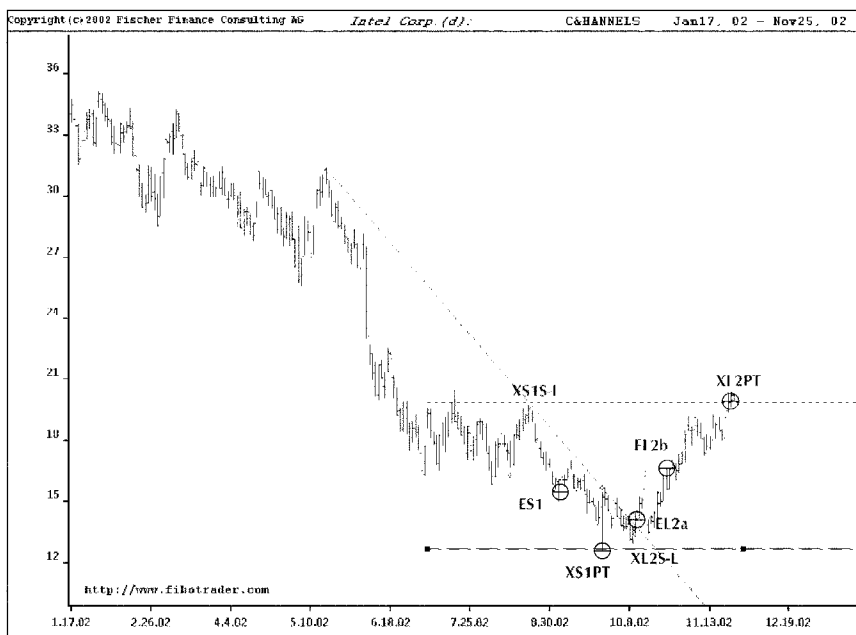

Figure 6.26 Intel chart from 01-02 to 11-02. Sample trade.

Within a couple of weeks, the profit target, which is the upper resistance line of the rectangle, is reached at 19.89 USD. The short-term trader takes a profit of about 20 percent measured on the entry price.

In a long-term perspective, an alternative strategy for maintaining accumulated profits is to hold the position until a trailing stop is triggered.

If we doubled the width of the rectangle again as we did before, we would come to a second profit target level at 23.50 USD—which is a powerful and optimistic projection of the trading potential of the Intel stock.

Japanese Yen Cash Currency Sample Trade

In the Japanese Yen cash currency, a symmetrical triangle is broken to the upside at 118.90. The short-term oriented trader realizes a quick, but solid profit once the market price penetrates the high of the symmetrical triangle at 121.40.

In a long-term perspective, we can calculate two profit targets. The first one is the resistance line at 125.50, based on the chart pattern in May and June 2002. The second profit target is at 127.16, that is, twice the height of the symmetrical triangle. Figure 6.27 shows the long trade in the Japanese Yen cash currency and the corresponding stop-loss and profit target level(s).

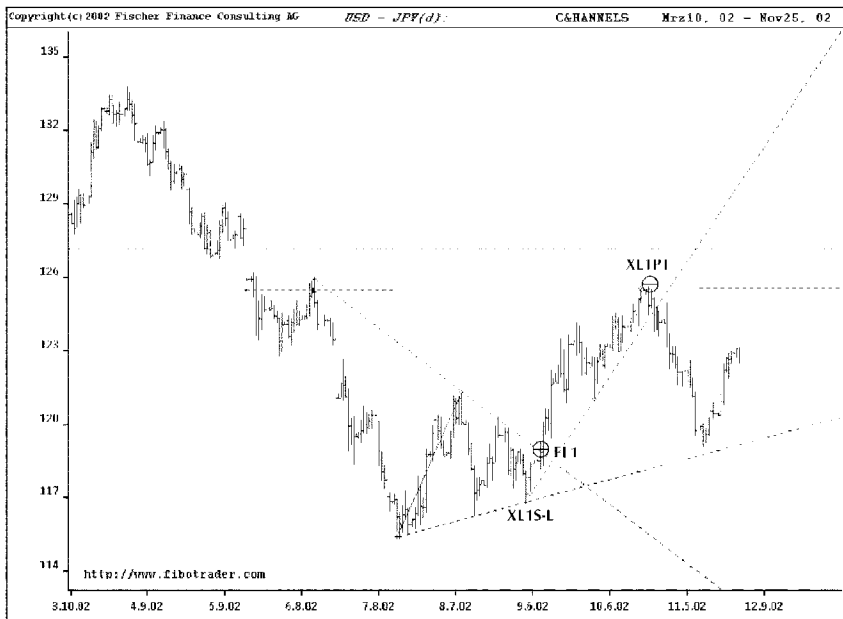

Figure 6.27 Japanese Yen chart from 03-02 to 11-02. Sample trade.

The experienced trader not only looks at the profit targets, but also carefully observes the overall picture. At the point where the first profit target is reached, we find a chart formation of an ascending triangle. We may wait for the second profit target, but more importantly, we may reverse our position and buy Japanese Yen against U.S. Dollars prior to triggering the second target price as soon as the support line of the ascending triangle is broken.

Dax 30 Index Sample Trade

Our final chart example, the Dax 30 Index, illustrates once again the symmetrical movement of market prices in stocks, stock index futures, cash currencies, and other trading vehicles.

Figure 6.28 shows three market entries in the Dax 30 Index as of September and October 2002. The first market entry is short, as in the previous Intel example. After reaching our target price short, we find two options for establishing a long position.

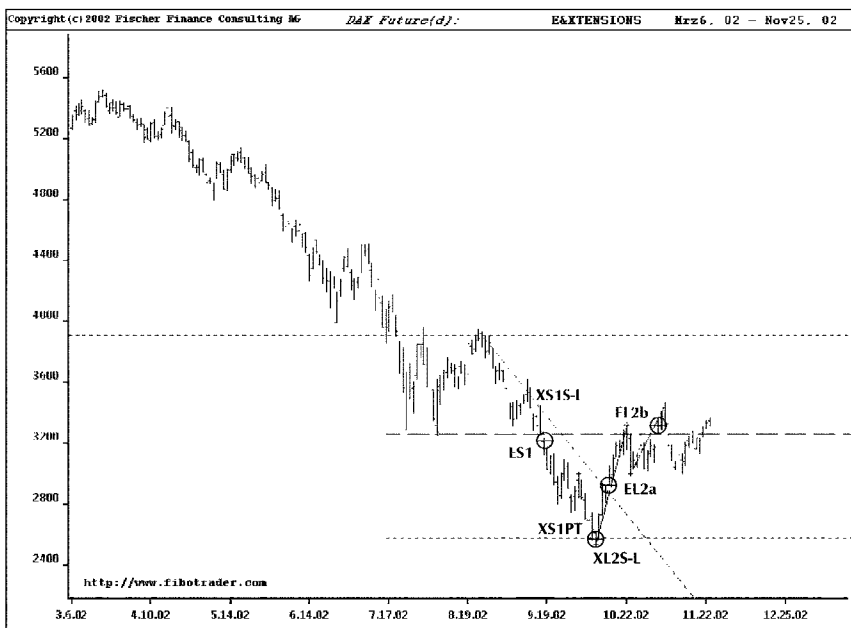

Figure 6.28 Dax 30 chart from 03-02 to 11-02. Sample trade.

The market entry short occurs when the level of 3,252.00 points in the Dax 30 Index (i.e., the support line) is broken. Doubling the width of the rectangle points at a price target at 2,572.00. The lowest low of the price move can be found at 2,536.00.

The first buy signal can be generated when the resistance line of the symmetrical triangle and the lowest peak are broken at a price level of 3,000.00 points. Traders with the discipline to execute a buy signal at this price level can liquidate the position at the first resistance line at 3,252.00.

The alternative, second buy signal is at 3,330.00 after the breakout of the market price at the resistance line. The new profit targets are at the price levels between 3,908.00 and 3,938.00. The first price target at 3,908.00 is the resistance line of the rectangle already used to calculate the sell signal. The second price target at 3,938.00 is twice the distance from the valley at 3,000.00 to the peak at 3,461.00.

We can use this chart pattern because it has formed three valleys at the bottom. We do not use the distance between the low at 2,536.00 and the high at 3,330.00 for the calculation because the price target would be at 4,099.00. This is a good example of price clusters formed by a resistance line and a Fibonacci price target being better qualified than those based exclusively on the Fibonacci ratios.

What this example also shows is that with the rotation of the market price, there is also a rotation between support and resistance lines. What is the support line when we get a sell signal becomes the resistance line once the market price changes the direction and moves up again.

Summary

Is finding a good entry point easier than knowing where to sell? Most traders have a problem being consistent in their investment strategy. Long-term profit targets mean big swings and big stop-losses. Short-term profit targets mean smaller profits and smaller stop-losses. A strategy with big profits at a small stop-loss risk does not exist, even though everybody would like to have it.

In this section, we introduced a concept that suggests when to liquidate an open position. What makes trading with resistance and support lines so valuable is that they adjust dynamically to different



swing sizes and work for entry and exit signals as well—if the trader has the discipline to follow the trading rules.

There are two ways to work with profit targets. The first way is to generate an entry signal when the market price breaks out of a trading range, such as a rectangle; the profit target is then twice the height of the rectangle. The second way is to generate the entry signal out of a trend line such as a symmetrical, ascending, or descending triangle. If the entry signal is close to the support line, the profit target is the resistance line, and vice versa.

As shown in the examples, getting to the first profit target can happen very quickly. Traders must decide whether to take the small, fast profits or stay longer in a trade and wait for the second profit target line. In strong bull or bear markets, staying longer in a trend makes a lot of sense. However, in sideward markets, taking profits a little earlier is the better strategy. Traders must determine what sort of market condition they are trading in and adjust their profit-taking strategy accordingly.

PHI-ELLIPSES

Several ellipses are available on different charting tools. *We call our trading tool the PHI-ellipse because it is a transformation of the original formula of the ellipse used in geometry.*

The PHI-ellipse is ideally suited for trading because it incorporates different Fibonacci ratios and changes its form dynamically—bigger, smaller, thinner, or thicker—based on these ratios. *The PHI-ellipse is protected by a trademark and cannot legally be copied.*

PHI-Ellipses on Daily Data

As described in detail in Chapter 5, the basic structure of PHI-ellipses is always the same, even though they can be thinner or thicker, shorter or longer depending on the market situation. The strength of PHI-ellipses is that they can be dynamically adjusted to any price move, as long as the required peaks or valleys are available.

There are two ways to work with PHI-ellipses. The first way is to analyze a trending market. If the market is going down, we are looking for a buy signal. If the market is going up, we try to find a sell



signal. In short: We are looking for turning points countertrend to the market action. The second option is working with PHI-ellipses that are placed horizontally on the chart. In these cases, we are looking for breakouts either up or down out of the PHI-ellipse. In other words: We get trading signals in the direction of the market trend.

PHI-Ellipses Countertrend

We can draw PHI-ellipses if we have at least three points, the starting point and one point on either side of the PHI-ellipse.

Because PHI-ellipses can only be drawn after a 3-wave price swing (two impulse waves and one corrective wave), the second impulse wave has to be at least as long as the first impulse wave.

In most cases, the longer the PHI-ellipse, the stronger is the price correction if we analyze the end of the market swing correctly. This is why products like the S&P 500 Index, Nasdaq 100 Index, Dax 30 Index, DJ EuroStoxx 50 Index, cash currencies, or financial futures with high volatility and big price swings can be best traded with the PHI-ellipse.

Once the first PHI-ellipse can be drawn based on a 3-swing price pattern, we still might not have found the final form of the PHI-ellipse. Although we have chosen the starting point and two side points correctly, the final form might be longer or shorter, thicker or thinner. To solve this problem, we combine PHI-ellipses with 3-point chart patterns and candlestick patterns. We can also anticipate the final point of the PHI-ellipse with support and resistance lines, or with Fibonacci correction levels and extension levels.

We have explained Fibonacci ratios, candlestick charts, and 3-point chart patterns in detail in the previous chapters to help interested traders find suitable combinations for entry rules that lead to higher profits at controlled risk.

The following examples are typical of profitable combinations of PHI-ellipses, candlestick patterns, and 3-point chart patterns. The selected charts can only be reworked by using the free WINPHI program that accompanies this book. Traders who want to test our strategies online and/or intend to develop their own strategies based on our recommendations can find an excellent analysis platform at www.fibotrader.com.

Our first example of a PHI-ellipse trade countertrend in combination with candlestick charting and regular chart patterns is on



the S&P 500 Index between May 2002 and November 2002 (see Figure 6.29).

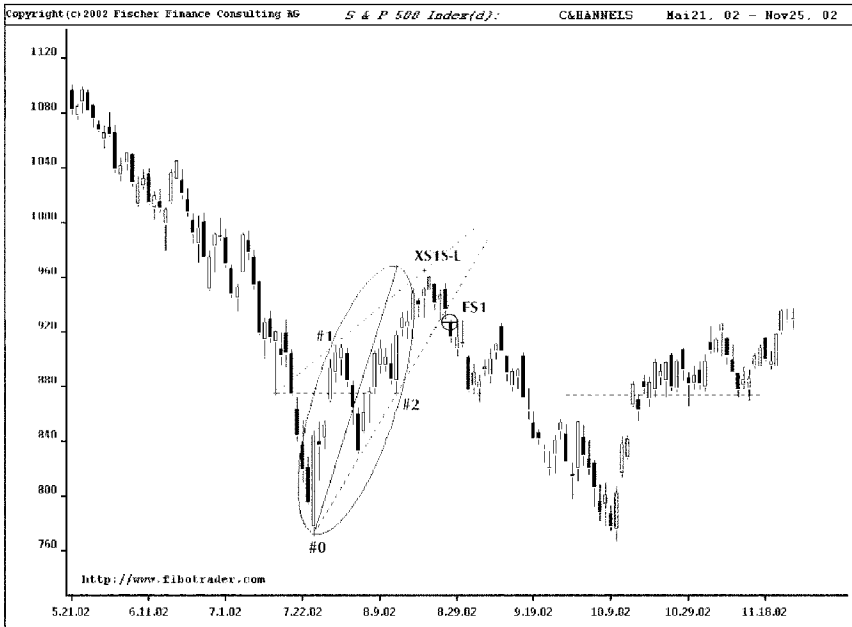

Figure 6.29 S&P 500 chart from 05–02 to 11–02. Sample trade.

After the first impulse wave from point 0 to point 1 and the correction from point 1 to point 2 are finished, we can draw a PHI-ellipse as soon as the market price in wave 3 (the second impulse wave) goes higher than point 1. The PHI-ellipse has its starting point at 0 and its two side points at 1 and 2.

While the market price moves higher, we try to find the final point of the PHI-ellipse. The first sign that the price move is slowing down becomes obvious when the market price moves out of the PHI-ellipse.

The sell signal can be analyzed as follows:

- The market price moves out of the PHI-ellipse.
- A wedge chart pattern confirms the end of the market trend.

- A candlestick engulfing pattern confirms the sell signal when the market price breaks out of the support line of the wedge formation.
- The profit target is set to 50 percent of the total swing from the starting point 0 of the PHI-ellipse to the highest high of the market movement.
- The stop-loss is placed at the peak before the short entry.

The strong price movement to the downside leads to a solid profit on the position. A buy signal in the S&P 500 Index shows up just two months later (see Figure 6.30).



Figure 6.30 S&P 500 chart from 05-02 to 11-02. Sample trade.

We start the PHI-ellipse at point 0. The two side points of the PHI-ellipse are at valley 1 and peak 2. Our primary goal is to define a market entry long once the final point of the PHI-ellipse is reached and the market moves out of the PHI-ellipse.

We conduct the analysis according to the following parameters:

- A candlestick engulfing pattern confirms the trend change after the breakout of the PHI-ellipse.
- A 2-day high breakout after the double bottom formation confirms the trend reversal additionally.
- The first profit target is at the resistance line at 875.00. The second profit target is marked by the resistance line at 925.00. After the breakout of the trading range between 875.00 and 925.00, doubling the size of the trading range leads to a third profit target at 976.00.
- The stop-loss point is at the valley before the buy signal.

Figure 6.31 provides us with a third trading example, this time on the Japanese Yen cash currency between March and November 2002.

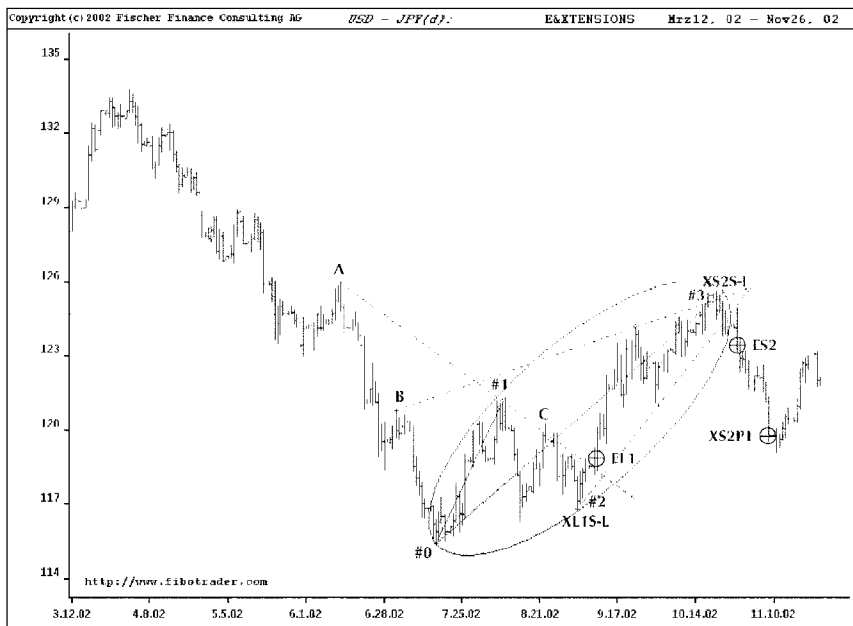

Figure 6.31 Japanese Yen chart from 03-02 to 11-02. Sample trade.

The buy signal stems from a breakout out of a symmetrical triangle, which is also the beginning of wave 3 (the second impulse wave) of the market move. While the market moves higher, the sell signal is based on the following rules:

- Point 3 (in Figure 6.31) marks the final point of the PHI-ellipse. The market trend stops at the resistance line. A symmetrical triangle is formed that has its apex almost at the high of the PHI-ellipse.
- We sell short when the support line of the symmetrical triangle and the outside line of the PHI-ellipse are broken. The profit target is at 50 percent of the swing size from point 0 to point 3.
- The stop-loss is placed at the peak before the sell signal.

Finally, the Deutsche Telekom stock provides a striking chart example of trading tools in combination (see Figure 6.32).

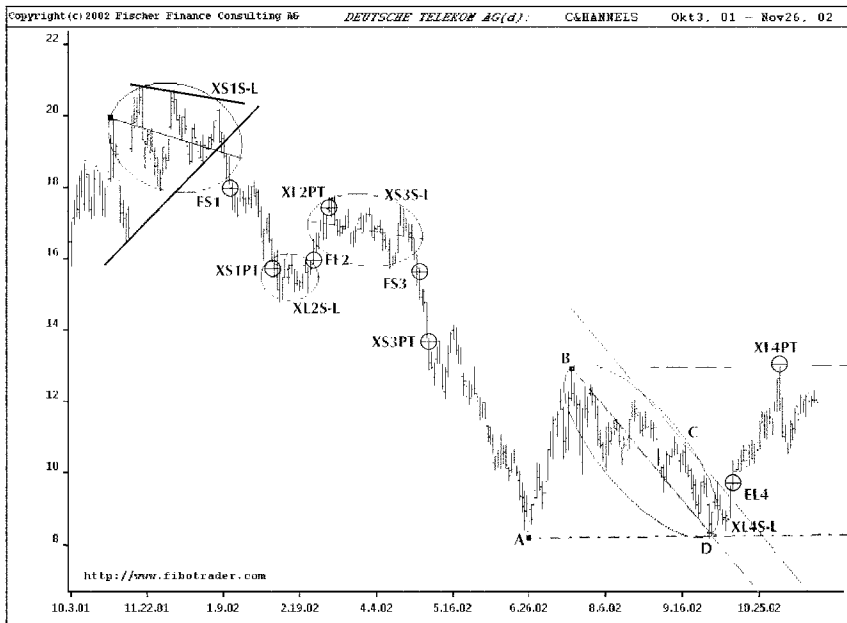

Figure 6.32 Deutsche Telekom chart from 10-01 to 11-02. Sample trade.

The most interesting trading signal on the Deutsche Telekom chart is the fourth one, the long entry EL4. The buy signal is based on a clear set of rules:

- A perfect PHI-ellipse can be drawn circumventing the market move from points B to D.
- We find a double bottom formation at point D (the second bottom is located at point A).
- Point D is also the head of an (inverted) head and shoulder formation.
- We enter the market long on a breakout of the outside line of the PHI-ellipse, which at the same time is a breakout of the peak between the head and the right shoulder of the head and shoulder chart formation.
- The profit target is triggered at the resistance line, which is defined as the parallel line to the support line running from point A to point D.
- The stop-loss is placed at the most recent valley before the long market entry.

The countertrend trading signals based on PHI-ellipses in various combinations with candlestick patterns and/or regular chart patterns have come out perfectly.

It is just a small step to turn the approach upside down and analyze market entries at the final points of PHI-ellipses in the direction of the main trend.

PHI-Ellipses in the Main Trend Direction

At least as important as countertrend PHI-ellipses are those PHI-ellipses that can be traded in the direction of the main trend.

All PHI-ellipses that trade with the direction of the trend have an almost horizontal position. Sideward patterns are often difficult to detect, and these horizontal PHI-ellipses are valuable because they make such patterns visible.

The goal in trading horizontal PHI-ellipses is to participate in small price swings with a high number of profitable trades at controlled



risk. However, many traders discover that this kind of trading demands higher discipline to execute the trading signals because higher slippage and commissions can take away much of the profit potential.

In general, what makes PHI-ellipses relevant trading tools for sideward markets is that they can be adjusted dynamically to different sideward patterns. This is where most traders lack a trading tool. The PHI-ellipse shows not only how far a sideward market might go, but also where the stop-loss level and the profit targets are. We have designed stop-loss and profit taking rules by ourselves, and there is no reason other traders cannot come up with profitable solutions that suit their personal needs.

We provide a few chart examples to illustrate how to apply horizontal PHI-ellipses in a profitable manner. We start with the S&P 500 Index between May and November 2002 (see Figure 6.33).

The PHI-ellipse in Figure 6.33 surrounds a chart pattern that shows a significant peak at 965.00 and two significant valleys at

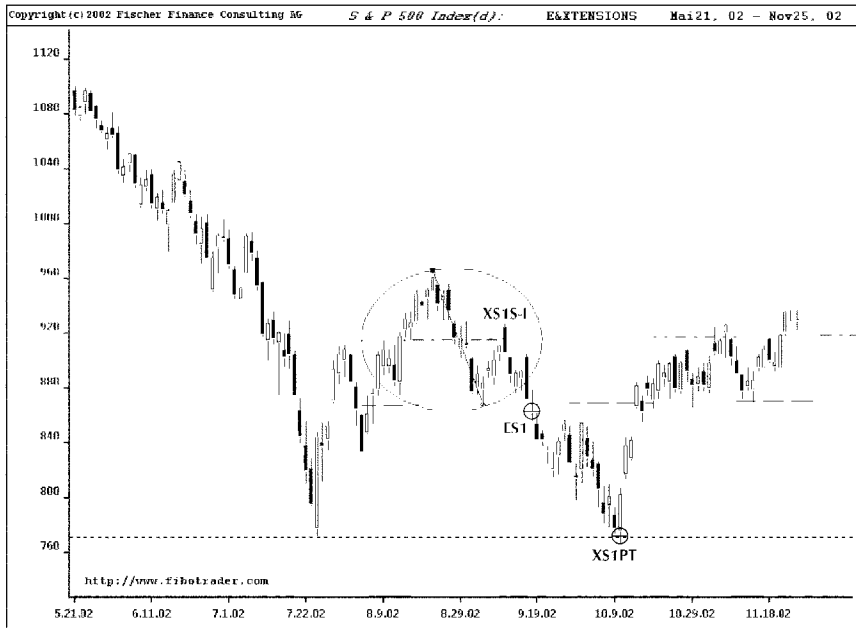

Figure 6.33 S&P 500 chart from 05–02 to 11–02. Sample trade.

875.00 and 868.00. Basic requirements for a countertrend PHI-ellipse are a starting point and two side points. In contrast, since we lack a starting point on horizontal PHI-ellipses, basic requirements for PHI-ellipses in the direction of the main trend are peaks and valleys on the upper border, lower border, or median line of the PHI-ellipse.

The most important factor to watch while working with horizontal PHI-ellipses is that the PHI-ellipse is locked in, meaning that it cannot be moved higher or lower any more. It is the constellation of peaks and valleys that gives stability to a horizontal PHI-ellipse. In our S&P 500 Index example, we get overall stability through the two peaks in the middle that touch the median line of the PHI-ellipse.

A sell signal is filled in the S&P 500 Index once the support line of the PHI-ellipse is broken. The profit target is twice the distance between the peak at 965.00 and the valley at 868.00. The new resistance line is identical with the low of the price movement at 771.00 points (where we take our profit). The stop-loss is placed at the peak before the sell signal.

A couple of horizontal PHI-ellipses can also be seen in Figure 6.32. Long entry EL4 was discussed earlier; the two short entries ES1 and ES3 and the long entry EL2 are the ones that we focus on in this section.

The first short entry is based on a PHI-ellipse locked in with three peaks on the upper side, one peak and one valley on the median line, and one valley at the lower side of the PHI-ellipse. Incorporated in the PHI-ellipse movement is also a symmetrical triangle. When the valley at the border of the PHI-ellipse is broken, we get filled on our sell signal. The profit target is reached at twice the width of the PHI-ellipse. The stop-loss is placed at the peak prior to the sell signal.

The first long entry is based on a very small PHI-ellipse. Although most traders might think such a small PHI-ellipse would not be significant enough for trading, it demonstrates that PHI-ellipses can be dynamically adjusted to bigger and smaller price moves.

The PHI-ellipse in question gets its stability from two peaks on the upper border and two valleys on the lower border. The buy signal is executed when the upper border of the PHI-ellipse is broken. The profit target is twice the total width of the PHI-ellipse. The stop-loss is at the valley before the market entry.

The PHI-ellipse on which the second short entry is based gets its stability from two peaks touching its upper border, two peaks touching



the median line, and one valley touching the lower border. The peak/valley configuration gives a unique form to the PHI-ellipse; any other ellipse would not completely surround the market move.

The sell signal is filled on a sharp breakout of the PHI-ellipse to the downside. The profit target is twice the total width of the PHI-ellipse. The stop-loss point is at the peak before the short entry.

To help readers follow our explanation and description of trading signals most easily, Figure 6.34 shows the Deutsche Telekom chart again.

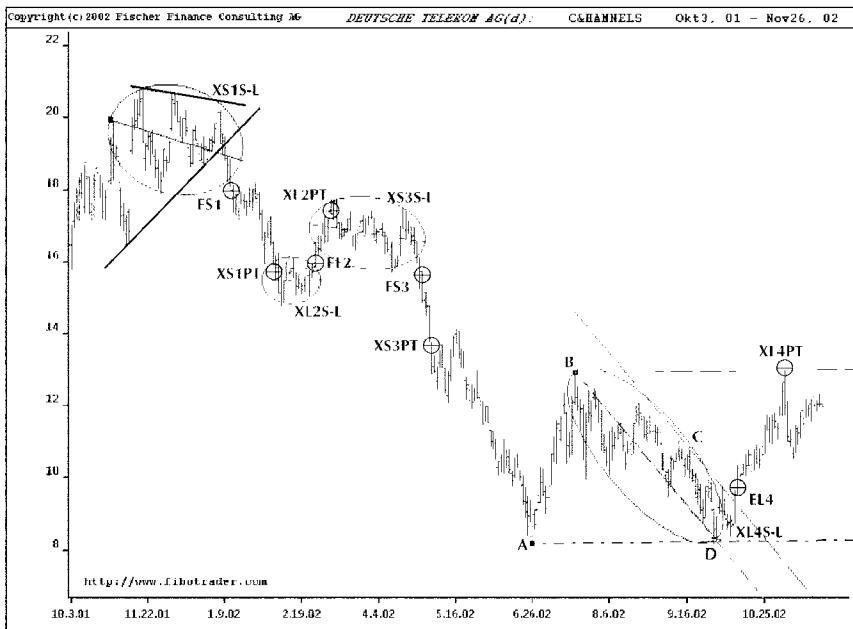

Figure 6.34 Deutsche Telekom chart from 10-01 to 11-02. Sample trade.

Before we discuss PHI-ellipses in combination with candlesticks and/or 3-point chart patterns on an intraday basis, we want to present a final striking example of horizontal PHI-ellipses as a tool to invest short-term in the direction of the main trend. The product in this example is the stock of U.S. chipmaker Intel over almost two years between December 2000 and November 2002, as shown in Figure 6.35.

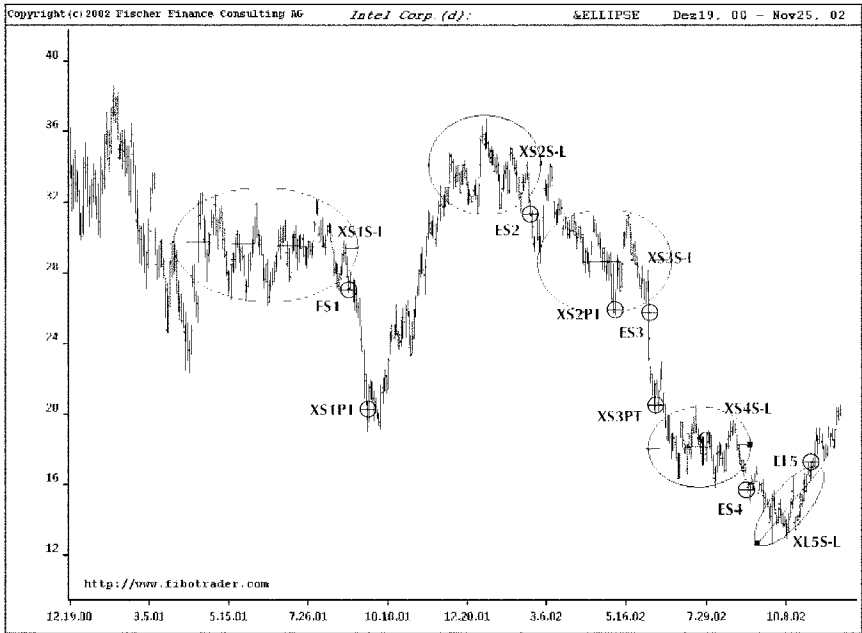

Figure 6.35 Intel chart from 12–00 to 11–02. Sample trade.

Five sample trades show up on the chart, four short trades and one long trade.

The first short trade is based on a PHI-ellipse that has four peaks on its upper border and four valleys on its lower border. The sell signal is executed when the lowest valley is broken. The profit target is calculated by doubling the total width of the PHI-ellipse. The stop-loss is placed at the peak before the sell signal.

The second short trade is based on a rare example of a PHI-ellipse with one peak in the middle on the top border, three valleys touching the median line, and three valleys on the lower border. The sell signal is filled when the lowest valley is broken. Shortly after the short entry, the market price reverses, but does not trigger the stop-loss point at the peak before the sell signal. The profit target is reached after three months at the target price, precalculated by doubling the total width of the horizontal PHI-ellipse.

To generate the third short signal, we can identify three peaks on the upper border of the PHI-ellipse, a peak and a valley touching the

median line, and one valley on the lower border. Once the valley on the lower border is broken, we get a sell signal. The stop-loss is placed at the peak before the sell signal. The profit target is calculated by doubling the width of the PHI-ellipse.

The last of the four short signals is based on two peaks on the upper border, two valleys on the lower border, and a single peak touching the median line of the PHI-ellipse. We get a sell signal on a breakout of the lowest valley. The stop-loss point is at the peak before the sell signal. In this case, the profit target is not reached. The stop-loss is not triggered, either, so the position is reversed as soon as the only long signal in our Intel example shows up.

The long sample entry is based on a PHI-ellipse with a steep slope to the upside. As explained in Chapter 5, we can get a buy signal on a breakout of the PHI-ellipse to the upside if we use an entry rule saying that we buy at the high of the day at which market pricing breaks out of the PHI-ellipse.

As our selected examples have made clear, horizontal PHI-ellipses are ideal tools for short-term investments in the direction of the main trend on a daily basis. Moreover, horizontal PHI-ellipses are also the link between daily chart analysis and intraday analysis.

SUMMARY

In this chapter, we combined the three concepts of candlestick charting, Fibonacci trading tools, and 3-point chart patterns. While each concept by itself is very interesting for a trader to work with, we were able to show by combining them that the number of trading signals is reduced and at the same time chances of profitable trades are increased.

The biggest problem while working with the PHI-ellipse by itself is to determine its final point. We can draw a PHI-ellipse when we have three points, the starting point and two side points. While we always need to have a 3-wave price move to draw the PHI-ellipse, the second impulse wave in a 3-swing price pattern has to be at least as long as the first impulse wave. Once we can draw the first PHI-ellipse, it will very rarely have its final form already, for it will dynamically adjust to the price pattern in the future. It can be longer or shorter, thicker or thinner.

In order to identify the final form of the PHI-ellipse and with it the entry price of a new position, we can combine the PHI-ellipse with,



for example, a PHI-channel line, which is the outside line parallel to the median line of the PHI-ellipse. We can also combine the PHI-ellipse with candlesticks or 3-point chart patterns. We can also anticipate the final point of the PHI-ellipse with support and resistance lines or Fibonacci corrections or extensions.

We have shown on different examples practical applications of the combination of PHI-ellipses with candlesticks and chart patterns. All examples show that by means of combining the trading tools, entry and exit points can be better defined. In addition, profit targets and stop-loss points can be better determined. We have presented a selection of stocks, stock index futures, and cash currencies to demonstrate that almost any product can be analyzed based on a combination of these trading tools. It does not make any difference whether we look for long or short signals on weekly, daily, or intraday charts.

Working with combinations of candlesticks, Fibonacci trading tools, and 3-point chart patterns means that we are most of the time not invested. We have to wait for patterns to develop and may enter the markets according to the signals generated by the analysis as soon as the setup is completed. Once we have a signal, we can precalculate the profit target and the stop-loss right away using the same trading tools. Following this approach, the percentage of profitable trades is very high at limited risk. An estimate of the percentage of profitable trades in chart patterns can be identified by looking at the score board shown in Table 4.10. The biggest problem for a trader is having the discipline and the patience to wait for the combination of the three trading concepts to develop and then not hesitating to act once a signal shows up.

The combination of the three trading concepts can be used to generate counter-trend signals to buy long at the bottom or sell short at the top of the PHI-ellipse. In these cases, the PHI-ellipse has either a slope upwards or downwards. The other option is to work with horizontal PHI-ellipse to analyze a sideways market. In this case, we are trading with the trend direction. We buy when the market price penetrates the outside line of the PHI-ellipse on the upside and we sell short, when the market price breaks out of the downside. To fine-tune the entry signals, entry signals based on the PHI-ellipse can be combined with candlesticks or 3-point chart patterns.

What makes the horizontal PHI-ellipse so interesting for the analysis of sideward patterns is that it can adjust dynamically to different market patterns. Whenever a PHI-ellipse is locked in—meaning the upside and downside of the PHI-ellipse are determined by different



peaks or valleys—we have to look for breakout signals. The combination of different chart patterns with the PHI-ellipse can result in such trading situations. Typically, a head and shoulder formation, a rectangle, a diamond, or a triangle can be formations that can be combined with PHI-ellipses. At the very end of the PHI-ellipse, the breakout either up or down can be accompanied by a candlestick pattern. The most important indication to look for is that different peaks and valleys on the upside, downside, and the median line give the PHI-ellipse a stable form.

Once the markets price breaks out of the PHI-ellipse, a decent profit target is the height of the PHI-ellipse. For the PHI-ellipse can be either thicker or thinner in each formation, the profit target can be either closer or further away. The height of the PHI-ellipse is the same as if we worked with the Fibonacci ratio 1.000. As the stop-loss price, we can use at its easiest form the median line of the PHI-ellipse. But stop-loss points and profit targets can be modified individually by the trader with rules of candlestick patterns, other Fibonacci trading tools like the PHI-channel, or different 3-point chart patterns as described in earlier chapters. The horizontal PHI-ellipse in combination with candlesticks or 3-point chart patterns can be used for daily and intraday data, for short-term or long-term analysis.

When evaluating the overall importance of the trading concepts, it can be said that candlesticks are the least important ones. They are only important if it comes to fine-tune the entry or exit signal. They are of importance if we are looking for countertrend signals at the bottom or top of the PHI-ellipse or for breakout signals when working with horizontal PHI-ellipses. But if we look at Fibonacci trading tools and chart patterns, it hardly can be said what is more important, for example, a head and shoulder formation, or a PHI-ellipse that surrounds the head and shoulder formation. But the only fact that counts is that through the combination of, for example, the PHI-ellipse with the head and shoulder formation, the trading signal becomes easier to identify, the stop-loss point can be placed without hesitation, and the profit targets are known already at the same time when the entry signal is generated.

This is what the whole book is about. The combination of candlesticks, Fibonacci trading tools, and 3-point chart patterns shall make you a more successful trader at less risk on each position traded.



SOME FINAL REMARKS

Our aim with this book has been to present easy, reliable trading devices that investors can combine with the trading rules and apply in real-time trading to improve their absolute return.

The weak performance by all of the so-called experts suggests that traders may do better if they manage their money themselves. Is it possible to develop absolute return strategies that result in portfolio profits by the end of every month, or at least by the end of every six months?

To have absolute return in a portfolio, the trading concept must implement some basic ideas:

- A systematic trading approach tested on historical data either with a computer or by hand.
- Five to ten products in a portfolio, analyzed by the same approach (a few products less might be sufficient on intraday portfolios).
- Long and short signals allowed.
- Stop-loss protection, profit targets, and/or trailing stops on every position.



We hope that reading this book has helped interested readers use the preceding criteria to find their preferred trading strategies.

For many decades, books, market letters, and other sources of information have been presenting investment strategies. We tried to select Fibonacci trading tools, candlestick chart patterns, and regular 3-point price patterns that are profitable when used alone—and even more profitable in combination. Combining different strategies correctly can improve the chances of success for investors in different market conditions.

No matter how good a trading approach is, a trader who does not know how to execute it will never be successful. We started the book with some basic principles of trading psychology and investor behavior. These are the factors that can lead to bad decisions in trading even though they have nothing to do with the trading strategy itself:

- Put your ego aside.
- Hoping and praying do not help.
- Living with losses has to be learned.
- Never double your losses.
- Know your pain level.
- Diversify risk.
- Making money with trading is hard work.
- Recognize the importance of a trading plan.
- Nothing is more important than discipline.

In Chapter 2, we referred to the magic figure three. If a trader believes as much in pattern recognition as we do, the key question is whether all the trading concepts behind Fibonacci trading tools, candlesticks, and regular chart patterns have a common denominator. Concentrating on the figure three is all that it takes to be successful, as long as these patterns are executed correctly and are combined with a stop-loss and profit target. How to do this is the subject of this book.

In Chapter 3, we introduced Fibonacci-related trading strategies, selected candlestick chart patterns, and a selection of regular 3-point



chart patterns. Applications of these trading strategies were then the subject of Chapter 4.

We started with Fibonacci price corrections and price extensions, and showed that they can be profitable trading tools if traders follow the parameters that make these strategies work.

Next, we analyzed candlestick chart patterns. Candlesticks enable traders to look at price moves differently, compared with looking at regular price bar charts. Candlestick charts show the momentum of each day's price moves. They are definitive and can be very helpful to the short-term trader. But the usefulness of candlesticks as a stand-alone trading tool has to be judged carefully. Test results from Rogalski Trading, Germany, which used the most common candlestick patterns on the Dax 30 Futures Index and the Euro-Bund Future over a longer period, were somewhat negative.

Finally, we tested 3-point chart patterns. These are some of the most important investment tools available. They express investor behavior and are among the very few consistent elements in the analysis of structures in price data. We are thankful to Mr. Thomas N. Bulkowski, who has put considerable effort into sorting chart patterns according to statistical criteria. These statistics indicate that some of the chart patterns we favor do very well and prove reliable in practical trading. The greatest advantage of working with chart patterns is that skilled traders can execute them without sophisticated computers. The 3-point chart patterns may look old-fashioned; however, they are powerful trading tools.

PHI-ellipses as trading tools were introduced in Chapter 5. PHI-ellipses are special because they make chart patterns visible. When working with PHI-ellipses, investors know always what to look for in the markets no matter how confusing the weekly, daily, or intraday charts might appear. With PHI-ellipses, traders can master trend patterns and sideward patterns. PHI-ellipses consist of three trading dimensions: price, time, and angle, which are seldom found in a single trading tool. When a solid analysis of all three dimensions precalculates the same turning point in a market, we can invest with confidence. PHI-ellipses are reliable long-term and short-term, and also on intraday data.

We concluded our analysis in Chapter 6 by presenting core combinations of Fibonacci trading tools with candlesticks and regular 3-point chart patterns.



Analyzing Fibonacci price corrections, we found that it is necessary to combine the most important Fibonacci correction level 61.8 percent with other parameters; traded by itself, it is simply too risky. While the combination with candlesticks improved results, combining the 61.8 percent retracement level with an entry rule, stop-loss rule, profit target, and 3-point chart patterns achieved the best outcome.

The combination with candlesticks and 3-point chart patterns can answer another key question of the Fibonacci ratios as well: Which retracement level is preferable—61.8 percent, 50.0 percent, or 38.2 percent?

Working with Fibonacci extensions can be important for calculations of long-term or short-term turning points in the markets. We found evidence that we can get to price clusters by combining different price targets. Combining support and resistance lines with Fibonacci price extensions and corrections identifies price clusters even more precisely than if we had worked only with Fibonacci ratios. Whereas support and resistance lines are based on peaks and valleys from the past, price targets calculated by the Fibonacci ratios are projections into the future. When both price levels overlap, we get close to defining secure entries and exits at major turning points in the markets.

Support and resistance lines can also be very powerful trading tools for determining entry and exit levels. We introduced two entry techniques: (1) analyzing breakouts of horizontal support and resistance lines and (2) generating entry signals out of trend lines. It depends on whether the strategy of the trader is to work with small, fast profits or to stay longer in a trade and wait for the next profit target. Market conditions also influence which strategy will work better at different times.

Finally, we combined PHI-ellipse trading with candlesticks, support and resistance lines, and 3-point chart patterns. We showed that traders can precalculate trend reversals more precisely if they combine PHI-ellipses with the Fibonacci ratios. Valuable confirmations of trend changes may also come from the application of trend channels, support and resistance lines, or regular 3-point chart patterns.

To prove that PHI-ellipses can be applied to intraday data as well, we presented some examples on 15-minute price data. PHI-ellipses have the very best trading potential on intraday data. Although it takes



discipline and great accuracy to execute trades, every successful trader has these abilities.

With the computer technology of the WINPHI program that accompanies this book (or available online for registered members at www.fibotrader.com), we strongly believe that we have developed pattern recognition to a higher level.





abcBourse.ir



@abcBourse_ir

مرجع آموزش بورس



بازنشر :

TUTORIAL

Readers who have reached these final pages might ask themselves if it was necessary to describe the strategies of Fibonacci trading tools, candlesticks, and regular 3-point chart patterns in so much detail and with so many examples.

The detailed explanations and numerous examples were provided to demonstrate the strategies' reliability and consistency.

THE WEB SITE, WWW.FIBOTRADER.COM

Traders who want to work with the Fibonacci trading tools, candlesticks patterns, and 3-point chart patterns online can go to our Web site.

The content of the Web site, www.fibotrader.com, is available on a membership basis. The Web site provides a 15-minute slide-show tutorial that includes:

- Understanding the Fibonacci principles.
- Crash course: Learning to use the WINPHI program.
- How to work real-time with the Fibonacci trading tools.
- Market letters.



- Two model portfolios for stocks and one model portfolio for futures and cash currencies.
- Information about the Web site, www.fibotrader.com.

We hope that the Web site will become the focal point for traders worldwide who want to update their trading knowledge and are looking for successful trading tools and strategies.



LIST OF ABBREVIATIONS

To keep bar charts easy to read when adding trading signals to them, we use a set of abbreviations for entry rules and exit rules according to the following definitions:

Entry Rules

EL **Entry Long**
ES **Entry Short**

Re-Entry Rules

R-EL **Re-Entry Long**
R-ES **Re-Entry Short**

Exit Rules

XL **eXit Long**
XLPT **eXit Long Profit Target**
XLS-L **eXit Long Stop-Loss**
XLTS **eXit Long Trailing Stop**
XS **eXit Short**
XSPT **eXit Short Profit Target**
XSS-L **eXit Short Stop-Loss**
XSTS **eXit Short Trailing Stop**





abcBourse.ir



@abcBourse_ir

مرجع آموزش بورس



بازنشر :

DISCLAIMER

Please read the following before opening the software package:

This WINPHI software is protected by copyright. The author and John Wiley & Sons, Inc., and their licensors, reserve all rights. You are licensed to use this software on a single computer. Copying the software to another format for use on a single computer does not violate U.S. copyright law. Copying the software for any other purpose is a violation of U.S. copyright law.

This product is not sold. It is provided with *Candlesticks, Fibonacci, and Chart Pattern Trading Tools* without warranty of any kind, expressed or implied, including but not limited to the implied warranty of merchantability and fitness for a particular purpose. Neither John Wiley & Sons (including its dealers and distributors) nor Fischer Finance Consulting assumes any liability for any alleged or actual damages arising from the use of this software.

This WINPHI software is tested only for Windows 95/98, Windows 2000/NT and Windows XP with minimum system requirements of Windows 95, 166 MHz Intel Pentium Processor, IBM-PC or compatible with CD-ROM drive, 32 MB RAM.

All charts printed in the book are created with a screen resolution of 1024 × 768 pixels. Different screen resolutions may lead to charts that differ from those shown in the book.





abcBourse.ir



@abcBourse_ir

مرجع آموزش بورس



بازنشر :

USER MANUAL WINPHI

GETTING STARTED

GETTING STARTED

Installation of the WINPHI Software from CD-ROM	234
Starting WINPHI—Approval of Disclaimer	234

BASIC DATA OPERATIONS

Configuring Comma Delimited ASCII Files	235
Choosing Data Files	236
Selecting Data from a Data File	236

BASIC CHARTING OPERATIONS

Selecting Fibonacci Trading Tools	238
Charting Corrections	239
Charting Extensions	240
Charting PHI-Channels	241
Charting PHI-Ellipses	242
Charting PHI-Spirals	244
Charting Fibonacci Time Goal Analysis	246
Working with the Constant Price Scale	247
OHLC Bar Charts versus Candlestick Charts	249
Exiting the WINPHI Software	249



INSTALLATION OF THE WINPHI SOFTWARE FROM CD-ROM

Insert the WINPHI CD into your CD-ROM drive. You will find the file **Setup40.exe** in the root directory. Start **Setup40.exe** by double-clicking the file in the Windows Explorer, or click the **Start** button and choose **Run** from the menu. Enter **X:\Setup40.exe** (**X:** being the drive letter assigned to your CD-ROM drive) and hit the **okay** button.

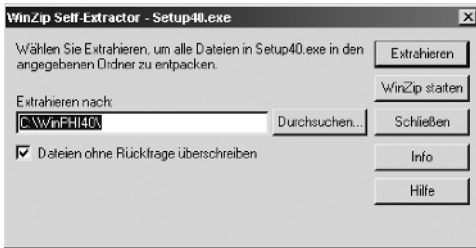

Enter the installation path. It is recommended to stick with the default **C:\WinPHI40**.

Left-click the **Extract** button (it reads **Extrahieren** in the German version of WinZip).

No drivers, DLL-files, or other configuration files need to be installed in a special setup routine.

Send a shortcut to your desktop pointing directly to the executable file **C:\WinPHI40\WinPHI40.exe**.

STARTING WINPHI—APPROVAL OF DISCLAIMER

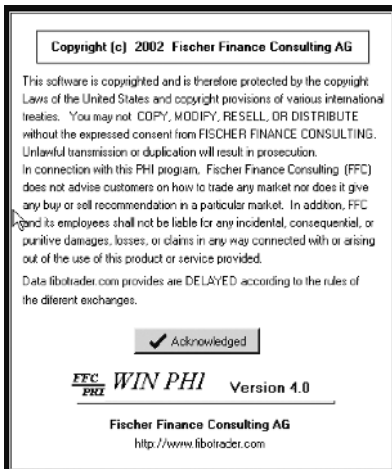

After installation is complete, run the WINPHI program from the Windows Start menu using the sequence **Start > Run > C:\WinPHI40\WinPHI40.exe**—or use the shortcut to the executable file that you have newly created on your desktop.

On startup of the WINPHI program, a copyright disclaimer is brought up. Read through the information carefully and **Acknowledge** the disclaimer by left-clicking the button to get to the WINPHI main screen.

CONFIGURING COMMA DELIMITED ASCII FILES

WINPHI only reads data files that are formatted as ASCII coded text files (comma delimited). The sets of data **must not contain headers** to define column content.

Daily, weekly, or monthly data files must contain the five necessary data fields Date—Open—High—Low—Close in exactly the given field order. Moreover, it is important to pay attention to the date format of the data records. The WINPHI program recognizes dates in the American format, which is **mm/dd/yyyy** (**mm** for month, **dd** for day, and **yyyy** for year). The year must be in four-digit format. Daily, weekly, and monthly data files bear the extension ***.txt**.

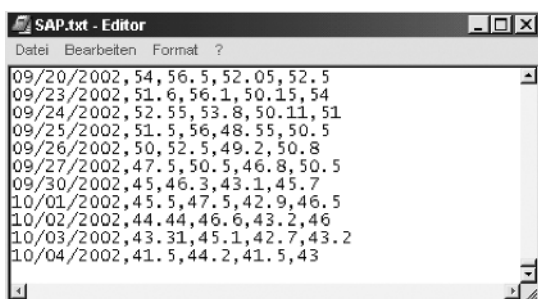

Intraday data files must contain the six necessary data fields Date—Time—Open—High—Low—Close in exactly the given field order. Moreover, it is important to pay attention to the date format of the data records. The WINPHI program recognizes dates in the American format, which is **mm/dd/yyyy** (**mm** for month, **dd** for day, and **yyyy** for year). The year must be in four-digit format.

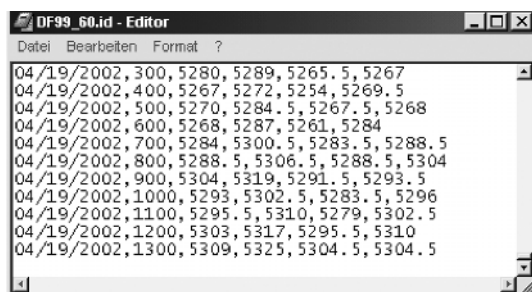

Sets of intraday data are automatically recognized by the WINPHI program as long as the data files bear ***.id** as their specific extension.

If the number of data fields, the field order in a file, or the file extension do not comply with the preceding criteria, an error message will appear. WINPHI will quit charting the respective data file.

CHOOSING DATA FILES

After installing the WINPHI program into the **\WinPHI40** directory, which can have any other name as well, you will note historical data files installed in the designated subdirectory **\Data**: selected cash currencies in **\Data\CashCurr**, selected futures in **\Data\Futures**, four sets of intraday data 15-min. and 60-min. for the Dax 30 Futures Index and the S&P 500 Futures Index in **\Data\Intraday**, and a small selection of stocks in **\Data\Stocks**.

Click on the **SYMB** button on the WINPHI speed bar to start working with data files of your choice. A window with the available sets of data pops up.

Browse through the subdirectories and click on the specific data record that you want to chart (e.g., EUR-USD.txt).

Make sure that the extensions ***.txt** for daily data and ***.id** for intraday data are always correct. The selected data file shows under **File name**.

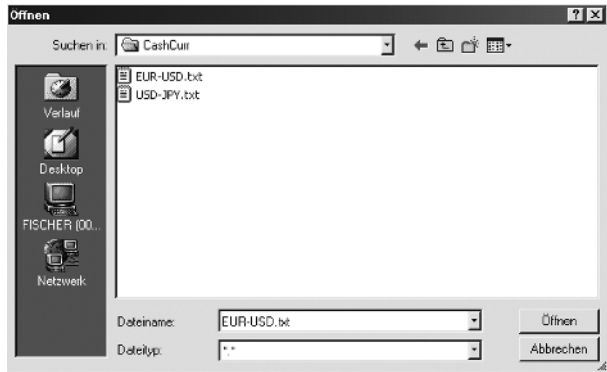

Click on **Open**. The bottom status bar should display the selected data file name.

SELECTING DATA FROM A DATA FILE

Left-click the **Dates** button. A new window captioned **Default Charting Setup** opens up.

Two basic options for the selection of charting periods are available. You can either make your charting selection based on 12 predefined time intervals (option **By Time Period**) or based on a variable selection of

continuously numbered parts of the data set (option **By Data Records**). Make your choice and mark one of the two options by left-clicking the respective bullet point.

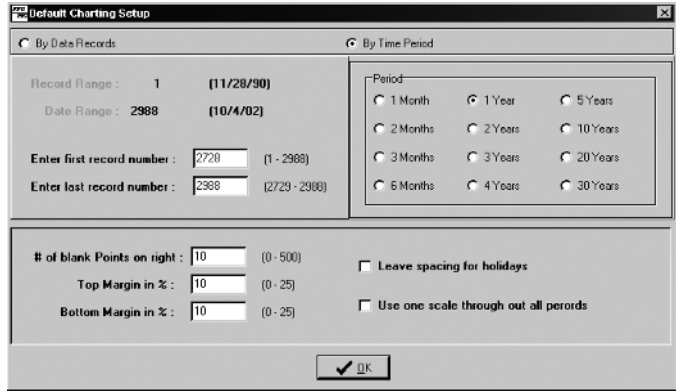

If you choose the option **By Data Records** from the two,

enter the requested starting point (**First record number**) and also the requested ending point (**Last record number**) out of the available records in the data set that you want to chart. If you choose the option **By Time Period**, left-click and select one of the twelve bullet points.

If you want to leave blank space on the right side of the chart to extrapolate the results of the selected trading tools into the future, you can enter any number of days, from zero day to 500 days in the **# of blank Points on right** edit box. Zero day (as default) would indicate no extra spacing on the right side of the chart. In addition, you may reserve 0 percent up to 25 percent of the screen height for extra space on the top part of the chart and 0 percent up to 25 percent of the screen height for extra space on the bottom part of the chart. The **Leave spacing for holidays** check box must be checkmarked to activate extra spacing in the chart according to the entry in the **# of blank Points on right** edit box.

If you want to chart all historical data in a constant price scale, checkmark the **Use one scale throughout all periods** check box. Further explanation of this topic is provided in a separate section, **Working with the Constant Price Scale**.

Left-click the **okay** button to continue.

SELECTING FIBONACCI TRADING TOOLS

Click the **P1** speed button.

Move the cursor to any point in the chart that you want to be the beginning point of an analysis. Click with the left mouse button on the point of choice to place the first point on the chart.

Click the **P2** speed button.

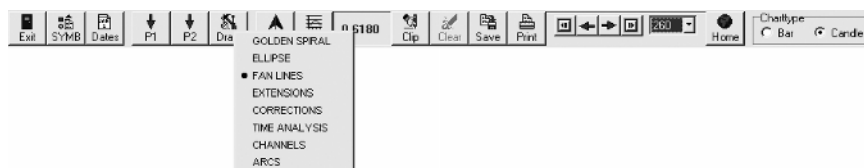

Move the cursor to any second point in the chart that you want to be the second point of an analysis for the selected trading tool. Click with the left mouse button on the second point of choice to place the second point on the chart.

Right-click on the **Draw** speed button to bring forth a list of Fibonacci trading tools.

Move the mouse pointer to a desired Fibonacci trading tool and left-click (a bullet point will appear next to the selected Fibonacci trading tool of the list).

Left-click again on the **Draw** speed button to draw a study.

Six geometrical Fibonacci trading tools can be applied as studies to the price charts:

1. Corrections.
2. Extensions.
3. PHI-channels.
4. PHI-ellipses.
5. PHI-spirals.
6. Fibonacci time goal analysis.

CHARTING CORRECTIONS

Corrections are a trading tool for analysis in price. The WINPHI program draws the retracement lines of 38.2 percent and 61.8 percent between highs and lows of choice.

Click the **P1** speed button to mark the **High** (or the **Low**).

Move the cursor to the **High** of choice in the chart and click with the left mouse button.

Click the **P2** speed button to mark the **Low** (or the **High**).

Move the cursor to the **Low** of choice in the chart and click with the left mouse button.

Click the **Draw** speed button with the right mouse button. Click with the left mouse button on **Corrections** from the list. A bullet point will appear next to the word **Corrections**.

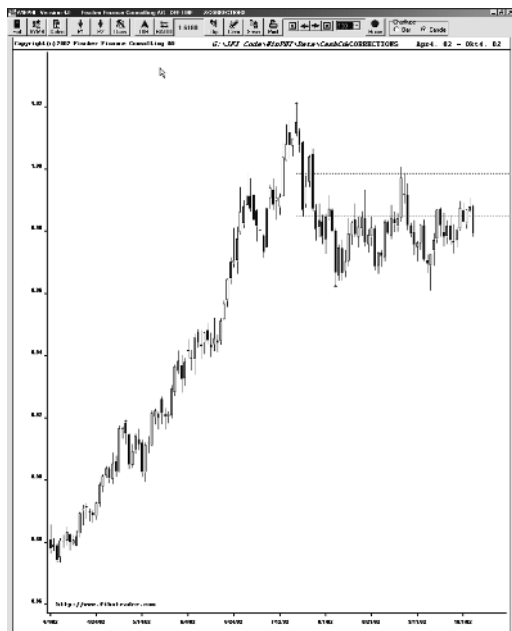

Left-click the **Draw** speed button again. The retracement lines of 38.2 percent and 61.8 percent will appear on the chart.

Click the **Clip** speed button, and the retracement lines are saved on the screen. We can overlay the screen with any of the other Fibonacci tools as well.



CHARTING EXTENSIONS

Extensions are used as Fibonacci trading tools to forecast trend reversals in the markets. The common Fibonacci ratios applied are 0.618, 1.000, 1.618, and 2.618.

Click the **P1** speed button to mark a significant **High** (or a **Low**).

Move the cursor to the **High**, and click with the left mouse button.

Click the **P2** speed button to mark a significant **Low** (or a **High**).

Move the cursor to the **Low**, and click with the left mouse button.

Click with the right mouse button on the **Draw** speed button. The menu list of the trading tools will appear. Click with the left mouse button **Extensions**. Next to the word **Extensions**, a bullet point will precede the selection.

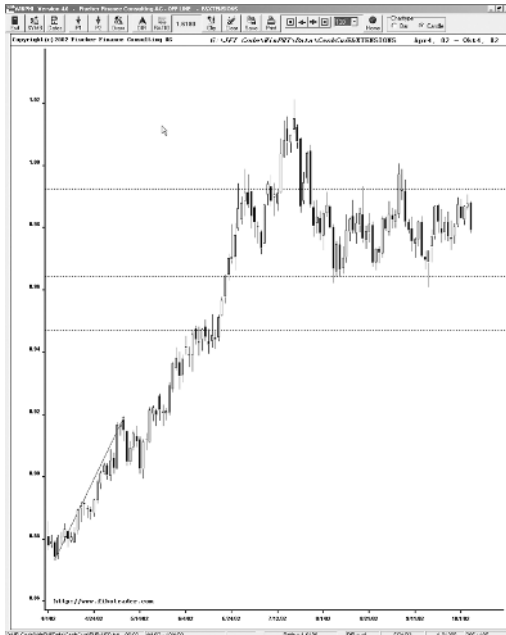

Left-click the **Draw** speed button again. The WINPHI system calculates the vertical distance between **P1** and **P2** and multiplies this distance by the Fibonacci ratio shown in the box next to the **Ratio** speed button.

By left-clicking the **Ratio** button, the Fibonacci ratios change.

When the icon on the **Dir** button points upward, the Fibonacci ratios will increase when you left-click the **Ratio** speed button. Conversely, when the icon

on the **Dir** button points downward, the Fibonacci ratios will decrease each time you click the **Ratio** speed button.

As long as the Fibonacci ratios used in the calculation give a price target that is still in the range of the size of the chart, the system will draw a horizontal line on the chart.

Each time you get a price target line, you can save this on the screen by clicking the **Clip** speed button. Once you have the price target lines you want to see, you can add other geometrical Fibonacci trading devices on the same chart.

CHARTING PHI-CHANNELS

Working with PHI-channels generates trend support and resistance lines by multiplying the difference from baseline to parallel outside line of the PHI-channel with different Fibonacci ratios. The baseline of a PHI-channel is created by connecting a significant **High** (or **Low**) with a significant **Low** (or **High**).

Click the **P1** speed button to mark the significant **High** (or the **Low**).

Move the cursor to the **High** of choice in the chart and click with the left mouse button.

Click the **P2** speed button to mark the significant **Low** (or the **High**).

Move the cursor to the **Low** of choice in the chart and click with the left mouse button.

Move the cursor to the outside point of the PHI-channel in the chart and click with the left mouse button.

Right-click the **Draw** speed button. Left-click on **PHI-channel** from the list of available trading tools. A bullet point will appear next to the word **PHI-channel**.

Click the **Draw** speed button with the left mouse button again. A chart containing the PHI-channel should be seen at this point. Depending on the choice of a Fibonacci ratio displayed in the ratio box,



the system now draws parallel lines to the PHI-channel, by multiplying the width of the PHI-channel with the Fibonacci ratios.

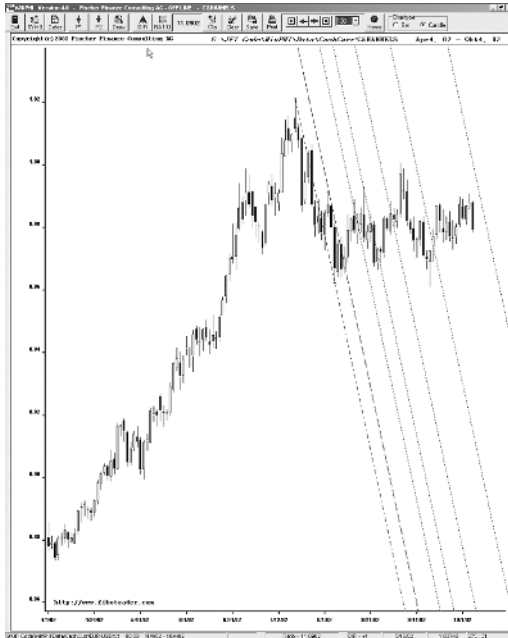

The Fibonacci ratios can be changed using the **Dir** and the **Ratio** buttons.

Left-click the **Clip** speed button each time you want to save a parallel line created with a different Fibonacci ratio.

PHI-channel support and resistance lines can be generated from different PHI-channels, thus creating a cobweb of parallel lines on the chart. On top of the parallel line series representing support and resistance lines, other Fibonacci trading tools can still be overlaid.

CHARTING PHI-ELLIPSES

PHI-ellipses can have many different shapes. They can be thinner or thicker, longer or shorter. But they will always have a basic structure founded on the Fibonacci ratios. To get started with a PHI-ellipse, you should look to select a significant high or low, and let the PHI-ellipse envelop the left and right side of a price move.

If you want to draw a PHI-ellipse, and you need additional free space on the right side of the PHI-ellipse to reserve enough room to show the full PHI-ellipse, you must go to the **Default Charting Setup** window, as introduced in the **Selecting Data from a Data File** section.



Under the **# of blank Points on right** option, enter the number of days for which you want to allocate free space on the right side of the chart, and checkmark the **Leave spacing for holidays** box.

Left-click the **P1** speed button. Move the cursor to the point in the chart where you want the PHI-ellipse to start, then left-click the mouse.

Left-click the **P2** speed button. Move the cursor to the point in the chart where you want the PHI-ellipse to end, then left-click the mouse.

Click the **Draw** speed button with the right mouse button.

Left-click on the trading tool **PHI-ellipse** of the list. A bullet point will appear next to the word **PHI-ellipse**.

Click with the left mouse button again on the **Draw** speed button. The PHI-ellipse will appear on the chart with a starting point you marked with the **P1** speed button and an end point you marked with the **P2** speed button.

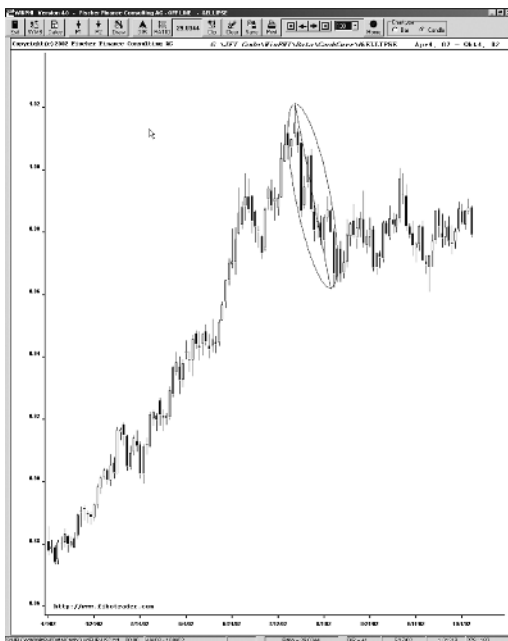

Most likely the first PHI-ellipse you draw will **not surround** the price move you want to analyze. To refine your draw, consider the following options.

To make the PHI-ellipse thicker or thinner, click the **Dir** speed button. The icon will point either upward or downward. Let us assume the icon on the **Dir** button points upward, and you left-click the **Ratio** button. Then, the Fibonacci ratio in the Fibonacci box next to the **Ratio** speed button will increase with each click. While the Fibonacci ratio increases, the shape of the PHI-ellipse becomes thinner. If you click the **Dir** button so that it points downward, and then click the **Ratio** speed button, the Fibonacci ratio decreases with each click. Each time the Fibonacci ratio decreases, the PHI-ellipse becomes fatter. If the Fibonacci ratio is 1.000, the PHI-ellipse gets shaped as a full circle.

To make the PHI-ellipse longer or shorter, move the cursor to the end point on the very right side of the PHI-ellipse, click with the right mouse button; and while **holding the right mouse button down**, you can drag the PHI-ellipse either to the right, left, up, or down. By doing so, you can make the PHI-ellipse longer or shorter.

You now possess the operational means to possibly fit the PHI-ellipse around the left and right outside points of any price move if there is a 3-wave price pattern. While you have enclosed the price move by the PHI-ellipse, you still do not know in real-time trading where exactly the end point of the price move will be. To identify the end of a price move, you need to read the respective sections in this book.

By clicking the **Clip** speed button, you can save the PHI-ellipse on the screen and then overlay it with other geometrical Fibonacci tools of your choice.

CHARTING PHI-SPIRALS

The PHI-spiral is a geometrical device for price and time analysis. The PHI-spiral rings can be support or resistance lines. The ultimate goal is to identify the point in price and time, where the crossover of two PHI-spirals is penetrated by the market price.

Left-click the **P1** speed button to select the **Center** of the first PHI-spiral. Click on any point in the chart to select the location of the **Center** of the PHI-spiral on the chart.



Left-click the **P2** speed button to select the **Starting point** of the first PHI-spiral. Click on any point in the chart to select the location of the **Starting point** of the PHI-spiral.

Click on the **Draw** speed button with the right mouse button.

Left-click on **PHI-spiral** from the list of trading tools. A bullet point will appear next to the word **PHI-spiral**.

Left-click on the **Draw** speed button. The selected PHI-spiral will appear on the screen.

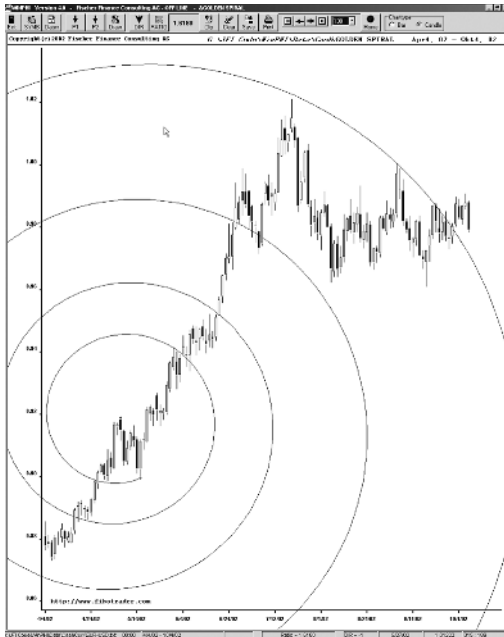

Once the PHI-spiral is drawn on the price chart, you can vary the **Center** by clicking on the **P1** button, placing a new point with a left mouse click, and then clicking on the **Draw** button. If you want to change the **Starting point** of the PHI-spiral, click on the **P2** speed button, place a new point with a left mouse click, followed by left-clicking the **Draw** speed button.

The PHI-spiral must have the Fibonacci ratio of **1.618**. When you start the first PHI-spiral, the default value of the Fibonacci ratio applied may be different from 1.618. To change the ratio, if the **Dir** button points upward, pressing the **Ratio** button will increase the Fibonacci ratio in the ratio box. If the **Dir** button points downward, pressing the **Ratio** button will decrease the Fibonacci ratio in the ratio box.

To change the rotation of the PHI-spiral, left-click on the **Dir** button; and the direction of the PHI-spiral will toggle between **counter-clockwise** rotation and **clockwise** rotation.

To save the PHI-spiral you have drawn on the chart, left-click on the **Clip** speed button, and the PHI-spiral will be saved on the screen. By saving the PHI-spiral on the screen, you can overlay the first PHI-spiral either with another PHI-spiral or with other Fibonacci trading tools from the menu list.

If you have saved the first PHI-spiral by using the **Clip** speed button, you can overlay on the chart another PHI-spiral by clicking the **P1** speed button, moving the cursor to the new **Center** of the second PHI-spiral, and left-clicking on the chart. For the new **Starting point** of the second PHI-spiral, click the **P2** speed button, move the cursor right to the new **Starting point**, and click on the chart with the left mouse button. Left-click the **Draw** speed button, and the second PHI-spiral will appear on the chart.

CHARTING FIBONACCI TIME GOAL ANALYSIS

The Fibonacci time goal analysis is an analysis for trend reversals in time. The WINPHI program can draw the time lines from any high or low in the price chart. The goal is to look for time bands, calculated from highs—highs and lows—lows. It is preferable to work with the ratios 0.618, 1.000, and 1.618, but the more advanced Fibonacci trader will learn how to work also with higher ratios.

Click the **P1** speed button to mark the **Low** (or the **High**). Move the cursor to the **Low** of choice in the chart and left-click.

Click the **P2** speed button to mark the second **Low** (or the second **High**). Move the cursor to the second **Low** of choice in the chart and left-click.

Click the **Draw** speed button with the right mouse button. Click with the left mouse button on **Time Goal Analysis** from the list of trading



tools. A bullet point will appear next to the word **Time Goal Analysis** in the menu list.

Click the **Draw** speed button with the left mouse button again. You will observe on the chart a line that connects the two **Lows** marked by the **P1** and **P2** speed buttons. Depending on the Fibonacci ratio selected in the ratio box, you can draw new time lines that are the distance between the two **Lows** multiplied by the Fibonacci ratio of your choice.

Once you have generated the Fibonacci time goal line with two **Lows**, you can use the same procedure to generate the Fibonacci time goal lines for the **Highs**. By doing so, using the correct Fibonacci ratios, you can generate time bands.

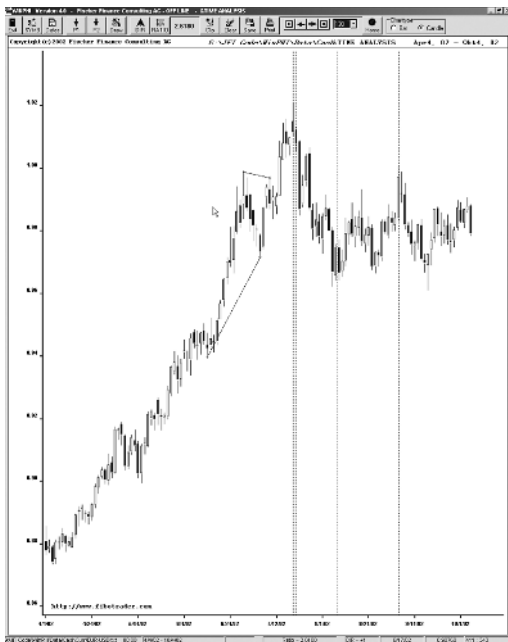

Left-click the **Clip** speed button, and Fibonacci time goal lines are saved on the screen. You can overlay any of the other geometrical Fibonacci trading devices on the screen as well.

WORKING WITH THE CONSTANT PRICE SCALE

The constant price scale is important when looking for stable parameters in a product on historical data. Serious analysts will test their findings on historical data first—before moving on to real-time trading.



Select a contract as instructed under **Choosing Data Files** by using the **SYMB** speed button.

Click the **Dates** button (see **Selecting Data from a Data File** section). Checkmark the **Use one scale throughout all periods** check box.

Change the **First record number** to any number of your choice, depending on how much data you want to analyze from the historical data file. Avoid accessing more than 2,000 data records, calculated as the difference between **First record number** and **Last record number**.

Note that there are more records stored in the hourly and 15-minute intraday Dax 30 and the S&P 500 data files. Providing these long data series allows any serious analyst to compare the signals on significant trend changes on weekly, daily, 60-minute, and 15-minute data over many years backward to test the reliability of the trading tools. Again, **do not load more than 2,000 data** into one file.

Next to the **Home** button located on the upper right side of the screen, you will notice a drop-down box displaying an initial number of **260**. The drop-down list reveals the number of price bars you can select to put on the chart for analysis).

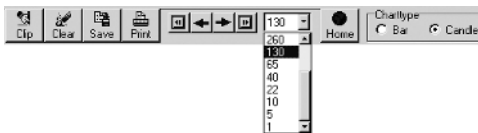

You find also four smaller control buttons left of the drop-down list displaying the number of days to chart. If you place the mouse pointer on any of these buttons, help text should appear to guide you with its function. Starting from the left-most control button, the functions of the four controls are **Draw beginning period**, **Shift to previous period**, **Shift to next period**, **Draw last period**.

If you work with the default value **260** and click on the left-most of the six smaller control buttons, you will have on the screen 260 price bars, starting from the beginning of the selected data file. Use the **Red-arrow** control buttons to move the data forward or backward the way you want to analyze it.

OHLC BAR CHARTS VERSUS CANDLESTICK CHARTS

WINPHI supports bar charts and candlestick charts. On the top right of the menu bar, users can select from bar charting and candlestick charting technique.

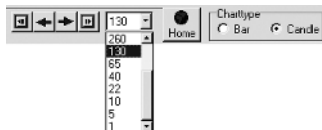

Candle is the default value for the charting technique. Changing to bar charting is just left-clicking the bullet point left of the option **Bar**. Returning to candlestick charting is simply reversing the procedure (i.e., left-clicking the bullet point left of the option **Candle**).

EXITING THE WINPHI SOFTWARE



Left-click the **Exit** speed button from the WINPHI task bar to leave the WINPHI program.

For questions and additional information, visit our Web site at **www.fibotrader.com**. Try out the online version of WINPHI with intraday datafeed, improved charting facilities, and many more international trading vehicles that can be analyzed real-time based on geometrical Fibonacci trading tools.



abcBourse.ir



@abcBourse_ir

مرجع آموزش بورس



بازنشر :

INDEX

A

Allianz, 67, 174–176, 186
ASCII format, 233, 235, 251

B

Bear trap, 17, 52–53, 68, 120
Belt-hold formation:
 bearish, 26–27, 171
 bullish, 26–27, 171
BMW, 93
Breakout, 6, 20, 33–41, 46,
 52–56, 65, 72, 91, 95–98,
 103–107, 115, 129,
 137–148, 156, 160–162,
 181, 186, 200, 206, 208,
 211–221, 226

Broadening formation, 39
Bull trap, 17, 46, 52–53, 68,
 120

C

Candlestick:
 analysis, 24, 26
 chart patterns, 26, 77–88,
 167, 170–171, 219,
 224–225
Chart pattern analysis, 32,
 217
Cob-web, 109, 242
Commerzbank, 105
Constant scale, 130,
 150–154
Continuation pattern, 36–38,
 88, 104



Correction, 14–17, 20, 24, 46,
52–71, 81–82, 116–117,
120, 129, 132–138, 142,
162–192, 195–196,
208–209, 215–222,
225–226

Counter-trend, 21, 70–71, 97,
109, 112, 116, 123–126,
142, 147, 163, 168, 187,
200, 208–209, 213, 215,
219–223

D

DaimlerChrysler, 101

Dark-cloud cover formation,
29–30, 85

Dax 30, 57, 67, 84–86,
153–164, 174, 177–178,
197, 199–200, 205–208,
217–221, 225

Deutsche Telekom, 103,
200–202, 212–216

Discipline, 48, 57, 111,
121, 131, 149, 155,
163–164, 168, 187, 200,
206–207, 214, 216, 220,
224, 227

Divine proportion, 9–10

DJ EuroStoxx 50, 47, 50, 57,
60, 64–66, 81–84, 155,
208, 217

Doji pattern, 29

Double:

bottom formation, 4

top formation, 4, 32–33, 46,

107

E

Eastman Kodak, 94

Elliott, 75, 87, 89, 114, 138,
155, 165

wave principle, 12, 22,
119–120

Engulfing pattern, 27–31, 79,
82, 85–86, 171, 210–211

Entry rule. *See* Trading rules

Evening star formation, 30–31,
80–86, 171

Exit rule. *See* Trading rules

Extension, 4, 16–19, 24, 46,
68–77, 120, 124, 128, 130,
134, 138, 141, 160, 164,
181–196, 199, 208,
219–220, 225–226

F

Fair value, 1

Falling peaks formation, 5, 35,
93, 101–102

False breakout, 38, 53

Fibonacci:

count, 131, 137–138

ratio, 9, 11, 13–14, 18–21,

69–70, 73, 75–76, 116,

130, 134, 142, 156, 167,

176, 182–187, 193, 221

summation series, 9–12, 19,

52–53, 75, 113, 116, 128,

130, 134, 137, 152, 164

trading tools, 14, 24, 26,

31–32, 42, 45, 77–78,

87–88, 92, 113, 116, 132,



145, 153, 155, 159, 162,
164, 172, 183, 187,
218–229
Filter, 46, 54, 163
Fischer transformation, 116, 119
5-wave pattern, 19, 68, 75–78,
138, 155, 187, 251
Flag formation, 5, 40

G

Golden:
rectangle, 13–14
section, 9, 13–14

H

Hammer formation, 26–27,
77–79, 82, 85–87, 99–100,
180–181
Hanging man formation,
26–27, 78–79, 85–86
Harami:
cross pattern, 28–29
pattern, 28–29, 79, 82, 171,
179
Head and shoulder formation,
34–35, 88, 93–95, 213, 221

I

IBM, 96, 200–201
Impulse wave, 14–22, 52,
57–60, 65–70, 73, 75–76,
87–90, 108, 115–120, 124,

133–134, 138, 141, 187,
208–209, 212, 220
Intel, 98, 100, 200, 203–205,
215–218
Intraday:
analysis, 216
data, 15, 24–25, 52, 54, 67,
124, 133, 150, 155, 159,
164, 167, 186, 216–217,
223, 226–227
trading, 6, 155
Investor behavior, 24, 26, 32,
41, 45, 78, 82, 105, 114,
155, 158–159, 164, 167,
174, 181, 195, 225
Irregular top or bottom, 17, 68,
136

J

Japanese Yen, 54, 57, 60,
62–64, 72–76, 97, 102, 130,
134–142, 144–145,
150–151, 192–194, 200,
204–205, 211

K

Key-reversal day formation, 26,
36, 41, 93, 99–100

L

Long position, 72, 91–92,
102–104, 110, 148, 157, 205



M

- Magic figure “three,” 5, 224
 Market symmetry, 33,
 112–113, 158–159
 Microsoft, 174–175, 186
 Minimum swing size, 18, 60,
 65, 69
 Morning star formation, 31, 80,
 83, 85–86

N

- Nature’s law, 10
 Nokia, 67, 95

O

- Outside line, 22, 109, 146–147,
 156, 158, 162, 186,
 212–213, 218–221

P

- Parthenon temple, 14
 Pattern recognition, 32, 88,
 125, 144, 146, 165, 172,
 179, 213, 224, 227
 Pennant formation, 40
 PHI-channel:
 baseline, 43–44, 109, 243
 outside parallel line, 44,
 108–109, 113

- resistance line, 36–43,
 103–104, 109, 112–114,
 182–183, 195–208,
 211–215, 219–220,
 225–227

- support line, 37, 42–43, 104,
 197, 200, 202, 205–215,
 218
 trend line, 109, 113–114
 PHI-ellipse, 4, 6, 20–23,
 105–152, 155–163, 186,
 192, 207–221, 226
 slope, 22, 117, 120, 123–126,
 132–133, 161–163,
 216–220

- Piercing pattern, 29–30
 Price band, 20, 71, 75–77,
 182–187, 189–196,
 200
 Profit potential, 22, 31, 54, 71,
 77, 84, 86, 88, 108,
 123–124, 127, 130–131,
 214

- Profit target rule. *See* Trading
 rules

R

- Rectangle formation, 5, 13, 38,
 93, 97–98, 200–203,
 206–207, 221
 Re-entry rule. *See* Trading
 rules
 Regular:
 chart pattern, 79, 209, 213,
 224
 price pattern, 20, 75, 225
 Retracement. *See* Correction



Rising valleys formation, 5, 35,
93, 101–102
Rule of alternation, 12–15

S

S&P 500, 47, 57, 60–62, 66,
85, 111–113, 134, 146,
148, 152–155, 164,
168–199, 208–210,
214–215, 217
Short position, 56, 72, 89–92,
102–104, 109, 126–127,
143–148, 156
Sideways market, 41, 108,
123–124, 133, 147, 149,
163, 174, 186, 207, 214,
220
Sneezewort, 11–12
Spring formation, 38
Stop-loss rule. *See* Trading
rules
Sunflower, 12–13

T

Target price, 18–19, 69–71,
142, 182–187, 192, 205,
218
3-wave pattern, 16–19, 68–69,
75, 77, 119, 136, 144, 152,
157, 189, 251
Trading:
concept, 24, 220–224
plan, 224
psychology, 224

Trading rules:

entry, 22–23, 48, 52–65, 71,
73, 93–94, 100, 104, 110,
126–127, 137, 141, 143,
146–147, 150, 162–164,
168, 171–174, 184, 186,
201, 208, 216, 219, 226
exit, 49–50, 56, 62, 72, 75,
84, 98, 104, 117, 125,
131–132, 140, 143, 164,
200, 217
profit target, 17, 33–41,
48–52, 56, 60–64,
70–75, 88–90, 94–105,
123, 128–130, 143, 150,
157–164, 200–207,
210–217, 220–226
re-entry, 60, 62, 163,
173–174
stop-loss, 16–19, 48–65,
70–74, 78–81, 89,
94–112, 126–128,
146–150, 156–157,
160–164, 169–172,
175–176, 179, 181, 186,
201, 204, 206, 210–216,
220–223, 225–226
trailing stop, 50, 56, 60–65,
72–75, 91–96, 99–105,
110, 128–130, 137–143,
146, 148, 164, 170–173,
203, 223
Trailing stop rule. *See* Trading
rules
Trend:
change, 31, 33–34, 36, 41,
46, 54, 77, 79, 101, 124,
145, 170, 172, 174,
180–183, 185–188,
192–197, 200, 211, 227



Trend (*Continued*)

- direction, 36, 39, 56, 58, 75,
77, 125, 145–146, 163,
171, 213, 221
- reversal, 26–27, 31, 43, 77,
79, 87, 93, 101, 105,
141–143, 162, 164, 178,
181, 184–197, 211, 226

Triangle:

- ascending, 37, 205
- descending, 37–38, 105,
201–203, 207
- symmetrical, 37, 40–41, 104,
204, 208, 212, 215

Triple:

- bottom formation, 33–38,
93–96, 174
- top formation, 33–34, 105

Turning point, 6, 23, 47, 70,

- 77, 108, 113, 138, 163, 167,
181, 184–185, 194–197,
208, 226

Tutorial, 229

U

Upthrust formation, 38–39

V

- Volatility, 15–16, 32, 47, 51,
56–57, 68, 134, 156, 158,
164, 175, 186, 208

W

Wave principle. *See* Elliott

- Wedge formation, 40–41, 107,
209–210

Width:

- PHI-channel, 44, 109
- PHI-ellipse, 215–218
- rectangle, 201–207
- trend channel, 200

WINPHI software package, 2,

- 5, 70, 113–114, 119, 122,
125, 130, 149–150, 159,
168, 208, 227, 229

www.fibotrader.com, 2, 148,

- 155, 159, 208, 216,
231–232

